

# STC1000S

STC1000S TRUCK CRANE  
100 TONS LIFTING CAPACITY

Quality Changes the World

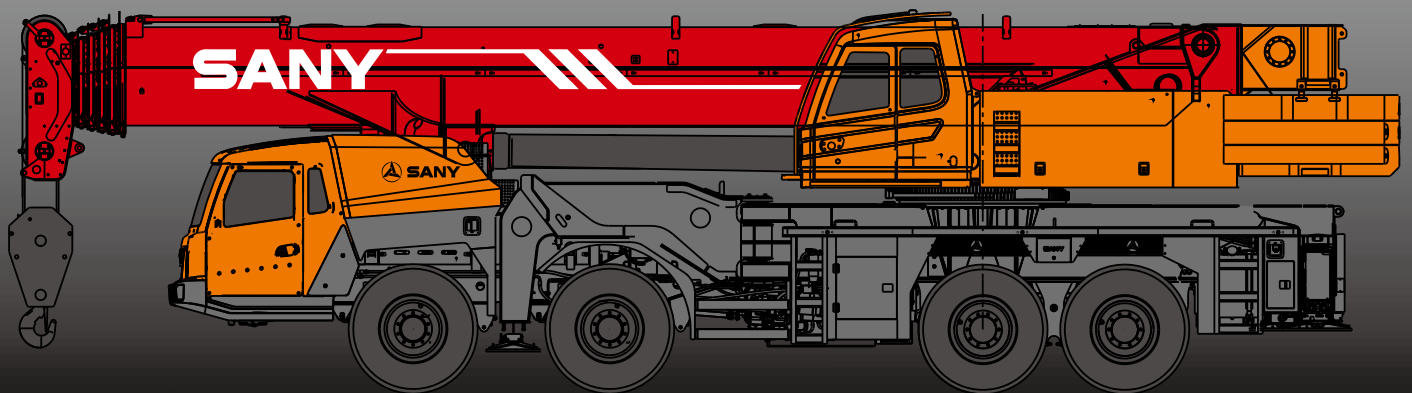

**SANY**

■ SANY Automobile Hoisting Machinery is one of the core business unit of Sany Heavy Industry, mainly engaged in the research and development of high end, mid to large tonnage crane series, including mobile crane, crawler crane, tower crane and loader crane. It has two industrial parks in Ningxiang and Huzhou, since entering the market, the products of Sany Automobile Hoisting Machinery have received worldwide recognition with advanced technology, lean manufacturing, high reliability and excellent service.



# SANY TRUCK CRANE

## CONTENT

- 04 Icon
- 05 Selling Points
- 06 Introduction
- 09 Dimension
- 10 Technical Parameter
- 11 Operation Condition
- 12 Load Chart
- 38 Counterweight sketch Map
- 39 Wheel Crane Family Map

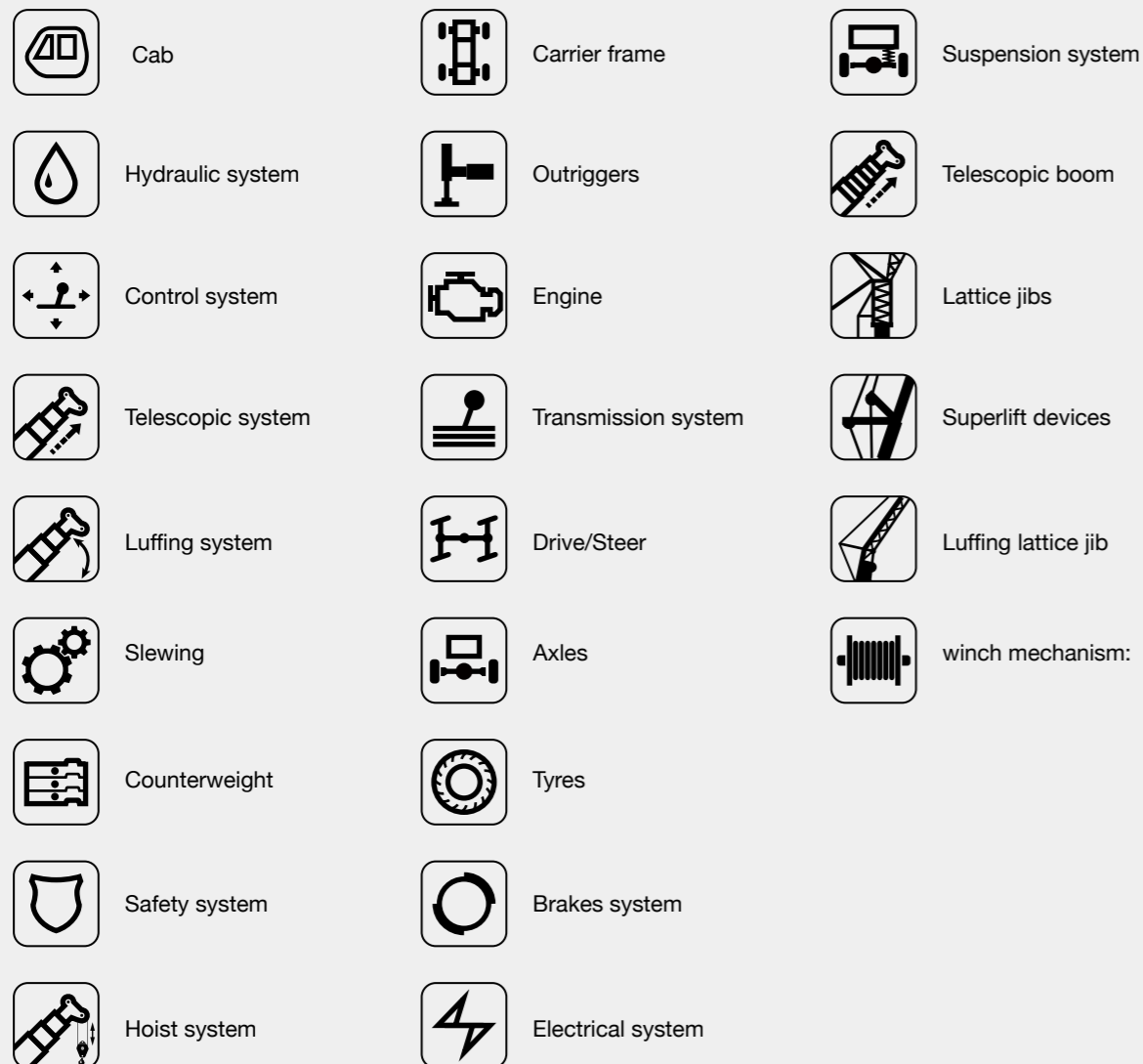

### Highly efficient and innovative chassis performance / chassis system

The use of innovative 4-axle chassis design and multi braking modes provide more reliable traveling performance for chassis. With tipping early-warning technology, high stable overall operation and high safety can be achieved.



### Highly efficient, energy-saving and unique hydraulic control technology

Self-developed dual-pump converging / diversion main valve is used. Converging flow of the single-action dual-pump ensures fast operation and high work efficiency, combined-action dual-pump diversion system is applied to ensure stable controllability. Electric proportional variable displacement piston pump is used to ensure high-accurate flow control and higher efficiency and energy saving.

### All axles Steered

The first crane of 100t class which could achieve all axles steered in the industry. It is designed as a compact and agile crane. 14m length is the shortest one in the 100t-class crane.

### Comfortable

385/95R25 tyre is equipped which is excellent in ability of cross-country with better stability. Sleeper is equipped in the driving cab providing comfortable condition for the driver.



### Safe and stable lifting performance / boom system

Six-section boom of high strength steel structure and optimized U-shaped section reduces weight significantly and improve safety rates. Jib mounting angles are 0°, 15° and 30° which ensures fast and convenient change-over between different operating conditions so as to improving working efficiency of the machine.



### Safe, stable, advanced and intelligent electronic control technology / electronic control system

Self-developed controller SYMC specially made for engineering machinery is adopted. The adoption of CAN-bus full-digital network control technology ensures stable control signal, simple harness and high reliability. Timely feedback of data information can achieve the monitoring of the overall working status in real-time. The load moment limiter equipped with the comprehensive intelligent protection system is used with accuracy within 5% to provide a comprehensive logic and interlock control, thus ensuring more safe and reliable operation.

### Light traveling weight

The first 100t-class crane of 4 axles and 6-section boom in China, with 46t overall weight it is the lightest crane compared to the same class crane.

### Low fuel consumption

The fuel consumption is 50L/100km which could low the cost of running and maintenance. It is the lowest compared to the same class crane.

## Superstructure

-  **Cab**
- The self-made cab adopts ergonomic design with sliding door, safety glass, anti-corrosion steel, soft interior decoration, large interior space, panoramic sunroof and adjustable seats, air conditioner and electric window wiper etc. to provide easier and more comfortable operation. Meticulously designed industrial style and novel appearance are applied for cab. Load moment limiter display is configured to achieve the combination of main console and operating display system, making all operating condition data of lighting operation clear at a glance.

-  **Hydraulic system**
- Through the adoption of load sensitive variable displacement piston pump, pump displacement can be adjusted in real-time, achieving high-precision flow control with no energy loss during operation.
  - Self-developed dual-pump converging/diversion main valve is used, enabling stable and convenient control of single action and combined action under different operation conditions.
  - Main winch adopts electric proportional variable motor to ensure high operation efficiency. Max. single line speeds of main winch is up to 135m/min and the auxiliary winch is 123m/min.
  - Opened slewing system with free slipping function is equipped to ensure more stable starting and control of the slewing operation as well as excellent micro-mobility.

-  **Control system**
- CAN-bus instrument: CAN-bus instrument with a combined intelligent control electrical system is used for easy reading of the traveling parameters at any time. The engine fault warning function is applied to ensure convenient and fast troubleshooting.
  - Automatic outrigger system: Electrically controlled outrigger with automatic leveling, which is easy to operate.
  - With fully security protection system, main and auxiliary winches are equipped with over-roll out limiter and height limiters to prevent over-rolling out and over-hoisting of steel rope, achieving limit angle protection.
  - Load moment limiter: The adoption of high intelligent load moment limiter system can comprehensively protect lifting operation, ensuring accurate, stable and comfort operation.

-  **Luffing system**
- The use of dead-weight luffing system with compensation control of the system ensures good luffing speed controllability, micro-mobility and excellent stability.
  - Luffing angle :  $-1^{\circ} \sim 81^{\circ}$ .

-  **Telescopic system**
- With single-cylinder pin technology, inserting and pulling actions of the cylinder pin and boom pin can be achieved through electrohydraulic control system.
  - Telescopic action of the lifting boom can be applied with a single telescopic cylinder. The use of multi-stage pressure control, multiple telescopic balance valve element and mechanical hydraulic double-interlock mechanism of the cylinder pin and boom pin ensure safe and reliable operation of the telescopic system.
  - Six-section boom is applied with basic boom length of 12.26m, full-extended boom length of 56m, jib length of 15.5m (one 6m extended boom is optional) and lifting height of fully extended boom is 77.5m including jib. It is made of fine grain high-strength steel with U-shaped cross-section .

-  **Slewing system**
- With  $360^{\circ}$  rotation and with Max slewing speed of 1.6r/min applied. The use of electrical proportion open-type slewing system ensures perfect operation and stable slewing.

## Superstructure

-  **Hoisting system**
- The adoption of pump and motor double variable speed control ensures high efficiency and excellent energy saving functionality. With perfect combination of winch balance valve and unique anti-slip technology of hook, heavy load can lift and lower smoothly. Closed winch brake and winch balance valve effectively prevent imbalance of the hook.
  - One 75t main hook (single hook): 725kg, one 10t auxiliary hook: 252kg. Optional configuration: one 75t hook (double hook) and one 100t hook (double hook). Wire rope of main winch: right-handed wire rope 260m. Wire rope of auxiliary winch: right-handed wire rope 170m.

-  **Safety system**
- Load detection is achieved through the establishment of accurate and concise load model, which significantly increases the overall system precision of load moment limiter. Online empty load marking effectively prevent inaccurate lifting caused by discrepancy in boom structure specification, increasing system accuracy to  $\pm 5\%$ .
  - Hydraulic system is configured with the balance valve, overflow valve and two-way hydraulic lock etc. components, thus achieving the stable and reliable operation of the hydraulic system.
  - Main and auxiliary winches are equipped with over roll-out limiter to prevent over rolling-out of wire rope.
  - Boom and jib ends are equipped with height limiters respectively to prevent over-hoisting of wire rope.
  - Boom head is equipped with anemometer to detect whether the high-altitude wind speed is within the allowable range.
  - It is equipped with the sensor of length and angle.

-  **Counterweight**
- There are four counterweight combinations, 0t, 8.5t, 16.5t, and 23.5, which is easy to install.
  - Rotary radius is 4400 mm.









## Chassis

-  **Cab**
- Cab is made of new steel structure self-developed by SANY, featuring excellent shock absorption and tightness, which is configured with swing-out doors at both sides, pneumatically suspended driver's seat and passenger seat, adjustable steering wheel, large rearview mirror, comfortable driver chair having a headrest, anti-fog fan, air conditioner, stereo radio and complete control instruments and meters, providing more comfortable, safe and humanized operation experience.

-  **Carrier frame**
- Designed and manufactured by SANY, anti-torsion box structure is welded by fine-grain high-strength steel plate to provide lighter weight and strong load bearing capacity.

-  **Axles**
- Axles 3 and 4 are drive axles and axles 1,2,3 and 4 are steering axles. Axle 3 and 4 would be the auxiliary steering when the traveling speed is  $\leq 30\text{km/h}$ . Axle and wheel differentials are installed in axle 3, and wheel differential is installed in axle 4.

## Chassis

-  **Engine**
- Type: Inline six-cylinder, water cooled, turbocharged and inter-cooling diesel engine
  - Rated power: 275kw/2100r/min
  - Emission: GB III standard
  - Capacity of fuel tank: 450L
-  **Transmission system**
- Gearbox: Manual gearbox is adopted with 10-gear and large speed ratio range applied, which meets the requirements of low gradeability speed and high traveling speed.
  - Transmission shaft: With optimized arrangement of the transmission shaft, the transmission is stable and reliable. For most optimized transmission, face-tooth coupling transmission shaft is used with large transmission torque.
-  **Brakes system**
- Brakes system includes traveling brake, parking brake, emergency brake and auxiliary brake.
  - Traveling brake: it is equipped with dual-circuit brake system. All wheels use the air servo brakes. The front axles are equipped with disk brake and the rear axles are equipped with drum brake.
  - Parking brake: axle 2,3 and 4 is controlled by the spring brake chamber.
  - For emergency brake, spring braking is used for emergency brake.
  - Exhaust brake is used for auxiliary brake.
-  **Suspension system**
- All axles adopt the plate spring suspension systems with plate spring passed 100,000 fatigue tests and with optimization of performance parameters of the front and rear plate springs applied to ensure strength and also to provide comfort ridding.
-  **Steering system**
- Dual-circuit hydraulic power steering system equipped with mechanical steering limit is used
-  **Outriggers**
- Made of fine-grain high-strength steel sheet, outriggers can be controlled through control panel with automatic leveling function. Front swing outriggers and rear telescopic outriggers are arranged. Four-point supporting ensures easy operation and strong stability with Max. span up to 7.8m×7.91m.
-  **Tyres**
- 8\*385/95R25
-  **Electrical system**
- With 2\*12V maintenance-free batteries, the crane power can be cut off manually via a mechanical master power switch. The use of CAN-bus control system can achieve information interaction between superstructure and undercarriage.

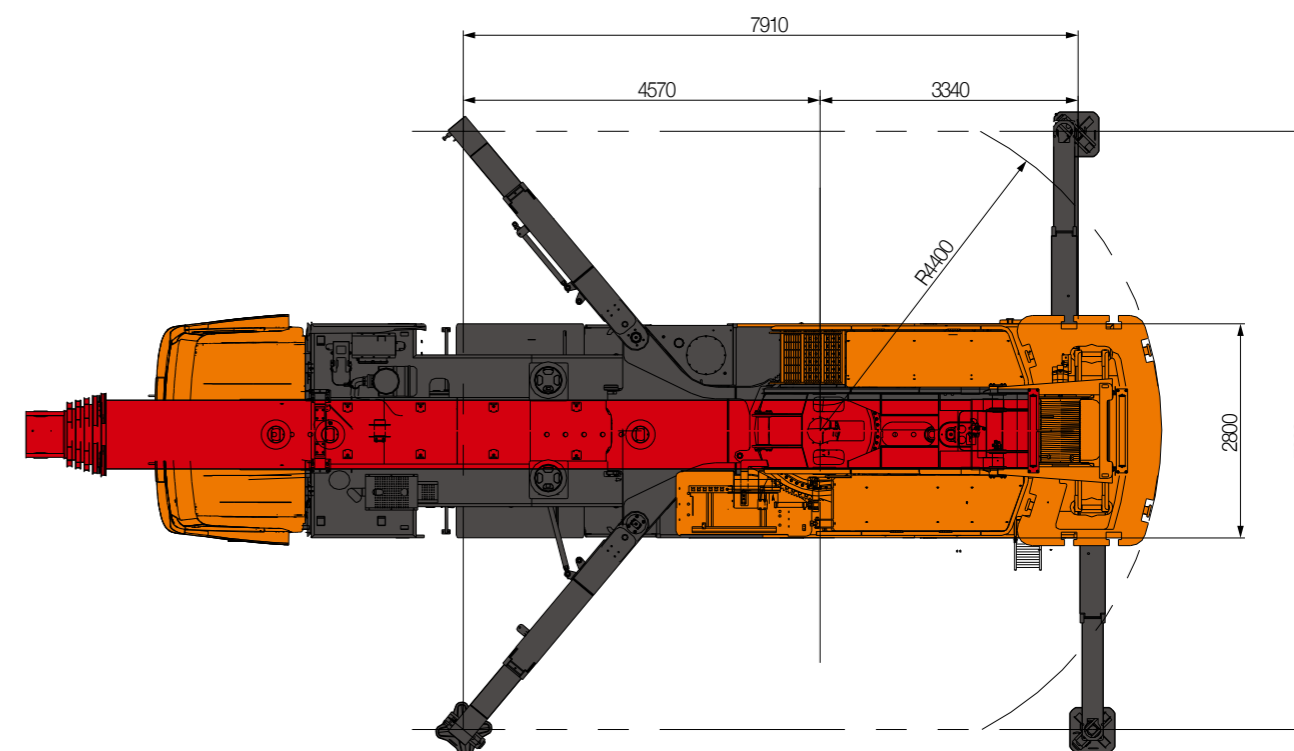
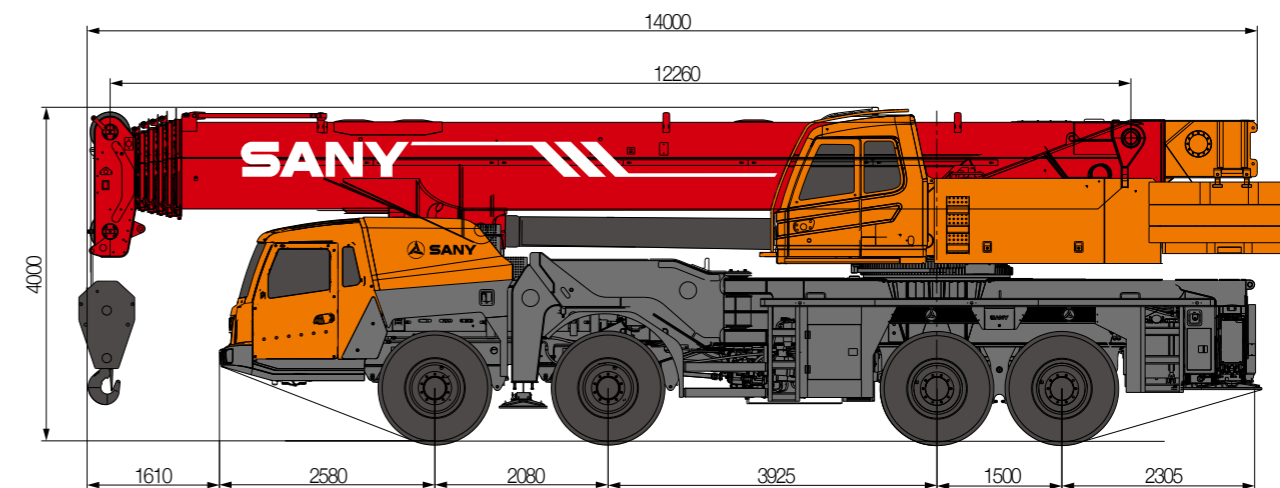

Type	Item	Parameter	
Capacity	Max. lifting capacity	100t	
Dimensions	Overall length	14000 mm	
	Overall width	2800 mm	
	Overall height	4000 mm	
	Axle distance	Axle 1,2	2080 mm
		Axle 2,3	3925 mm
Axle 3,4		1500 mm	
Wheel distance	Axle 1,2	2335 mm	
	Axle 3,4	2322 mm	
Weight	Overall weight	46000 kg	
	Axle load	Axle 1,2 (front axle)	22000 kg
Axle 3,4 (rear axle)		24000 kg	
Power	Engine	ISLe375 30	
	Rated power	275kW/2100rpm	
	Rated torque	1550N·m / (1100-1400)rpm	
	Emission standard	GB III	
Traveling	Max. travelling speed	80 Km/h	
	Min. stable travelling speed	1.89 Km/h	
	Turning radius	Min. turning radius	10.5 m
		Min. turning radius of boom tip	/
	Min. ground clearance	320 mm	
	Approach angel	21 °	
	Departure angel	19 °	
	Braking distance(30km/h)	≤10 m	
Max. gradeability	40 %		
Fuel consumption per 100km	≤50 L		
Main Performe Parameter	Max. rated lifting capacity	100 t	
	Min. working radius	3 m	
	Max. lifting torque	Basic boom	3300 kN.m
		Fully-extended boom	1824 kN.m
	Outrigger span	7.8 m × 7.91 m	
	Lifting height	Basic boom	12.26 m
		Fully-extended boom	56 m
		Fully-extended boom + jib	71.5 m (77.5 m)
	Boom length	Basic boom	12.26 m
		Fully-extended boom	56 m
Fully-extended boom + jib		71.5 m (77.5 m)	
Jib offset	0°, 15°, 30°		
Working Speed	Max. single rope lifting speed of main winch (no load)	123 m/min	
	Max. single rope lifting speed of auxiliray winch (no load)	123 m/min	
	Full extension/retraction time of boom	480 s / 500 s	
	Full lifting/descending time of boom	60 s / 80 s	
	Slewing speed	0 r/min ~1.6 r/min	
	Full extension/retraction time of horizontal outrigger	25 s / 15 s	
	Full lifting/descending time of vertical outrigger	40 s / 35 s	

STC1000S Working Ranges

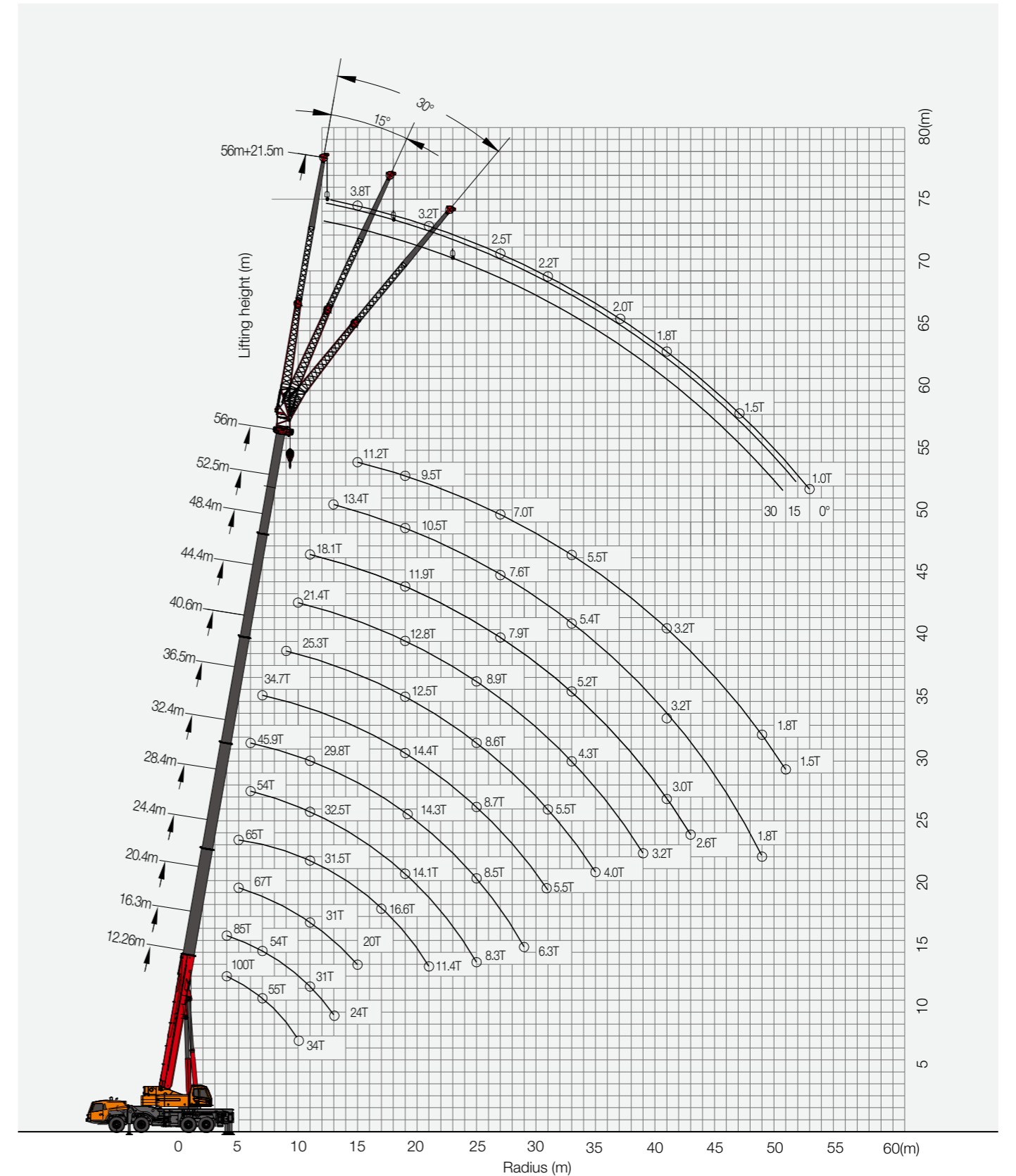

Unit:t

- Prerequisites:**  
 ① Boom operating conditions(fully extended boom length), max.length is 56m  
 ② The span of outriggers is 7.8m×7.91m  
 ③ 360°rotation is applied  
 ④ Counterweight is 0T

Working radius (m)	Main boom (m)												Working radius (m)	
	12.3	16.3			20.4				24.4					
3.0	100	85	80	67										3.0
3.5	84	80	78	62	73	73	73	48	70					3.5
4.0	78	75	70	58	67	67	67	46	65	65	65	49	55	4.0
4.5	70	69	64	54	65	65	65	44	60	62	62	46	52	4.5
5.0	64	63	60	51	60	60	60	41	56	58	58	45	50	5.0
6.0	50	50	51	45	49.5	49.5	49.5	38	48	51	51	41	46	6.0
7.0	35	35	35	36	34.5	35.5	36.3	35	35.7	37.2	37.7	35	36.4	7.0
8.0	25.5	25.5	26.5	27.5	26.5	26.5	27.3	28.8	26.7	27.9	28.3	29.2	27.5	8.0
9.0	20	20.5	21	21.5	20	20.6	21.6	22.9	21	21.9	22.3	23.3	21.7	9.0
10.0		16.5	17	17.5	16	16.8	17.4	18.8	16.8	17.6	18	19.1	17.6	10.0
12.0		11	11.5	12	10.5	11	11.8	13	11.3	11.8	12.1	13.4	12	12.0
14.0					7	7.7	8.3	9.5	7.8	8.2	8.6	9.9	8.6	14.0
16.0						5.4	6	7.2	5.5	5.9	6.2	7.6	6.3	16.0
18.0										4.1	4.4	5.9	4.6	18.0
20.0										2.7	3	4.6	3.3	20.0
22.0														22.0
24.0														24.0
26.0														26.0
28.0														28.0
30.0														30.0
32.0														32.0
34.0														34.0
36.0														36.0
38.0														38.0
40.0														40.0
42.0														42.0
44.0														44.0
46.0														46.0
48.0														48.0
50.0														50.0
52.0														52.0
54.0														54.0
No. of line	11	11	11	11	10	10	10	10	10	8	8	8	8	No. of line

Unit:t

- Prerequisites:**  
 ① Boom operating conditions(fully extended boom length), max.length is 56m  
 ② The span of outriggers is 7.8m×7.91m  
 ③ 360°rotation is applied  
 ④ Counterweight is 0T

Working radius (m)	Main boom (m)												Working radius (m)	
	28.4				32.4				36.5					
3.0														3.0
3.5														3.5
4.0														4.0
4.5	55													4.5
5.0	54	50	50	50	51	45.9	44	44	35					5.0
6.0	50	47	47	47	48	41.6	41	41	32	34.7	34.7	34.4	31.3	6.0
7.0	38.4	39	38.7	40.1	37.8	38.3	37.5	37.5	29	31.7	31.7	31.5	29.3	7.0
8.0	29	29.6	29.3	30.5	28.5	29	29.3	29.8	26.5	28.9	29.2	29	27.4	8.0
9.0	22.9	23.5	23.1	24.3	22.4	22.9	23.2	23.6	24.4	22.9	23.3	23.0	23.4	9.0
10.0	18.6	19.2	18.8	19.9	18.2	18.6	18.9	19.3	20.1	18.6	19.0	18.7	19.1	10.0
12.0	12.69	13.2	12.9	13.9	12.3	12.7	12.9	13.3	14.1	12.8	13.1	12.9	13.3	12.0
14.0	9	9.5	9.2	10.3	8.7	9.1	9.3	9.7	10.4	9.2	9.5	9.3	9.6	14.0
16.0	6.6	7.1	6.8	7.8	6.3	6.7	6.9	7.3	7.9	6.7	7.1	6.8	7.2	16.0
18.0	4.8	5.3	5	6	4.5	4.9	5.1	5.5	6.1	5.0	5.3	5.1	5.4	18.0
20.0	3.5	3.9	3.7	4.6	3.2	3.5	3.7	4.1	4.7	3.7	4.0	3.8	4.0	20.0
22.0	2.4	2.9	2.6	3.5	2.1	2.5	2.7	3	3.7	2.7	2.9	2.7	3.0	22.0
24.0	1.6	2	1.8	2.7	1.3	1.7	1.9	2.2	2.8	1.8	2.1	1.9	2.1	24.0
26.0						1	1.2	1.5	2.1	1.1	1.4	1.2	1.5	26.0
28.0									1.5					28.0
30.0														30.0
32.0														32.0
34.0														34.0
36.0														36.0
38.0														38.0
40.0														40.0
42.0														42.0
44.0														44.0
46.0														46.0
48.0														48.0
50.0														50.0
52.0														52.0
54.0														54.0
No. of line	7	7	7	7	7	6	6	6	5	5	5	5	5	No. of line

Unit:t

- Prerequisites:**  
 ① Boom operating conditions(fully extended boom length), max.length is 56m  
 ② The span of outriggers is 7.8m×7.91m  
 ③ 360°rotation is applied  
 ④ Counterweight is 0T

Working radius (m)	Main boom (m)														Working radius (m)
	40.6				44.4				48.4				52.5	56	
3.0															3.0
3.5															3.5
4.0															4.0
4.5															4.5
5.0															5.0
6.0															6.0
7.0															7.0
8.0	25.3	25.2	21	21.9											8.0
9.0	21.9	22.1	20.6	20.2	21.4	21.4	20.5	20.3							9.0
10.0	17.9	18.1	19	18.9	18.4	18.5	19.2	19.1	18.1	16.6	16.4	16.2			10.0
12.0	12.2	12.4	13.3	13.5	12.7	12.9	13	13.3	13.5	13.7	13.9	14.2	13.4		12.0
14.0	8.7	9.0	9.9	10.0	9.2	9.3	9.5	14.4	9.8	10	10.2	10.5	9.5	10.2	14.0
16.0	6.5	6.7	7.5	7.6	6.8	7.0	7.2	11.4	7.4	7.6	7.8	8	7.2	7.7	16.0
18.0	4.8	5.0	5.8	5.9	5.2	5.3	5.4	9.2	5.6	5.8	6	6.2	5.5	6	18.0
20.0	3.5	3.7	4.5	4.7	3.8	3.9	4.1	4.4	4.2	4.4	4.6	4.8	4.2	4.6	20.0
22.0	2.5	2.7	3.4	3.6	2.8	3.0	3.1	3.3	3.2	3.3	3.5	3.7	3.3	3.5	22.0
24.0	1.7	1.9	2.7	2.8	2.0	2.1	2.3	2.6	2.3	2.5	2.7	2.9	2.4	2.6	24.0
26.0	1.0	1.2	2.0	2.1	1.3	1.4	1.6	1.9	1.7	1.8	2	2.2	1.8	1.9	26.0
28.0			1.4	1.5		1.0	1.1	1.3	1.1	1.2	1.4	1.6	1.2	1.4	28.0
30.0			0.9	1.1								1.1	0.8	0.9	30.0
32.0															32.0
34.0															34.0
36.0															36.0
38.0															38.0
40.0															40.0
42.0															42.0
44.0															44.0
46.0															46.0
48.0															48.0
50.0															50.0
52.0															52.0
54.0															54.0
No. of line	4	4	4	4	3	3	3	3	3	3	3	3	2	2	No. of line

Unit:t

- Prerequisites:**  
 ① Boom operating conditions(fully extended boom length), max.length is 56m  
 ② The span of outriggers is 7.8m×7.91m  
 ③ 360°rotation is applied  
 ④ Counterweight is 8.5T

Working radius (m)	Main boom (m)												Working radius (m)	
	12.3	16.3			20.4				24.4					
3.0	100.0	85.0	80.0	67.0										3.0
3.5	84.0	80.0	78.0	62.0	73.0	73.0	73.0	48.0	70.0					3.5
4.0	78.0	75.0	70.0	58.0	67.0	67.0	67.0	46.0	65.0	65.0	65.0	49.0	55.0	4.0
4.5	70.0	69.0	64.0	54.0	65.0	65.0	65.0	44.0	60.0	62.0	62.0	46.0	52.0	4.5
5.0	64.0	63.0	60.0	51.0	57.6	60.0	60.0	41.0	56.0	58.0	58.0	45.0	50.0	5.0
6.0	52.0	51.0	54.0	45.0	50.0	52.0	52.0	38.0	50.0	51.0	51.0	41.0	46.0	6.0
7.0	42.0	43.5	42.5	41.0	43.0	43.0	43.0	35.0	45.0	44.0	44.0	37.0	41.0	7.0
8.0	35.0	35.5	36.5	36.0	35.5	36.3	37.0	32.0	36.4	37.9	38.3	34.5	37.0	8.0
9.0	28.5	28.5	29.0	31.0	28.2	28.8	29.5	28.8	28.9	30.2	30.5	32.0	31.1	9.0
10.0		23.2	24.0	25.5	23.0	23.6	24.2	25.5	23.7	24.7	25.1	27.2	25.6	10.0
12.0		16.5	17.0	18.6	16.3	16.8	17.3	18.5	16.9	17.6	17.9	19.9	18.4	12.0
14.0					12.0	12.5	13.0	14.2	12.6	13.2	13.5	15.3	13.9	14.0
16.0						9.5	10.1	11.2	9.6	10.1	10.4	12.2	10.8	16.0
18.0										7.7	8.0	9.8	8.5	18.0
20.0										6.0	6.3	8.0	6.7	20.0
22.0														22.0
24.0														24.0
26.0														26.0
28.0														28.0
30.0														30.0
32.0														32.0
34.0														34.0
36.0														36.0
38.0														38.0
40.0														40.0
42.0														42.0
44.0														44.0
46.0														46.0
48.0														48.0
50.0														50.0
52.0														52.0
54.0														54.0
No. of line	11	11	11	11	10	10	10	10	10	8	8	8	8	No. of line



Unit:t

**Prerequisites:**  
 ① Boom operating conditions(fully extended boom length), max.length is 56m  
 ② The span of outriggers is 7.8m×7.91m  
 ③ 360°rotation is applied  
 ④ Counterweight is 8.5T

Working radius (m)	Main boom (m)												Working radius (m)	
	28.4				32.4				36.5					
3.0													3.0	
3.5													3.5	
4.0													4.0	
4.5	55.0												4.5	
5.0	54.0	50.0	50.0	50.0	51.0	45.9	44.0	44.0	35.0				5.0	
6.0	50.0	47.0	47.0	47.0	48.0	41.6	41.0	41.0	32.0	34.7	34.7	34.4	31.3	6.0
7.0	45.0	44.0	44.5	44.0	43.5	38.3	37.5	37.5	29.0	31.7	31.7	31.5	29.3	7.0
8.0	39.0	39.5	39.0	40.0	38.5	35.0	35.0	35.0	26.5	29.2	29.2	29.0	27.4	8.0
9.0	31.1	31.5	31.0	32.5	30.7	29.5	31.4	31.8	24.5	27.0	27.0	26.5	26.0	9.0
10.0	25.6	26.0	25.8	26.9	25.2	24.3	25.9	26.3	22.5	24.8	24.8	24.6	24.3	10.0
12.0	18.4	18.5	18.6	19.6	18.0	17.5	18.7	19.1	19.8	18.6	18.9	18.7	19.1	12.0
14.0	13.9	14.4	14.1	15.1	13.6	13.2	14.2	14.5	15.2	14.1	14.4	14.2	14.5	14.0
16.0	10.8	11.3	11.0	11.9	10.5	10.3	11.1	11.4	12.1	11.0	11.3	11.1	11.4	16.0
18.0	8.5	8.9	8.7	9.6	8.1	8.1	8.7	9.1	9.7	8.7	9.0	8.8	9.1	18.0
20.0	6.7	7.2	6.9	7.8	6.4	6.5	7.0	7.3	7.9	6.9	7.2	7.0	7.3	20.0
22.0	5.3	5.8	5.5	6.4	5.1	5.1	5.6	5.9	6.5	5.6	5.9	5.7	6.0	22.0
24.0	4.2	4.7	4.4	5.3	4.0	4.1	4.5	4.8	5.4	4.5	4.8	4.6	4.9	24.0
26.0						3.2	3.6	3.9	4.5	3.6	3.9	3.7	4.0	26.0
28.0						2.6		3.2	3.8	2.8	3.1	2.9	3.2	28.0
30.0										2.2	2.5	2.3	2.6	30.0
32.0														32.0
34.0														34.0
36.0														36.0
38.0														38.0
40.0														40.0
42.0														42.0
44.0														44.0
46.0														46.0
48.0														48.0
50.0														50.0
52.0														52.0
54.0														54.0
No. of line	7	7	7	7	7	6	6	6	5	5	5	5	5	No. of line

Unit:t

**Prerequisites:**  
 ① Boom operating conditions(fully extended boom length), max.length is 56m  
 ② The span of outriggers is 7.8m×7.91m  
 ③ 360°rotation is applied  
 ④ Counterweight is 8.5T

Working radius (m)	Main boom (m)										Working radius (m)				
	40.6		44.4			48.4			52.5	56					
3.0											3.0				
3.5											3.5				
4.0											4.0				
4.5											4.5				
5.0											5.0				
6.0											6.0				
7.0											7.0				
8.0	25.3	25.2	21.0	21.9							8.0				
9.0	23.0	23.0	20.6	20.2	21.4	21.4	20.5	20.3			9.0				
10.0	21.5	21.5	19.0	18.9	20.1	20.1	19.2	19.1	18.1	16.6	16.4	16.2		10.0	
12.0	17.7	17.9	16.8	16.5	17.8	17.8	17.3	17.2	16.2	14.8	14.8	14.7	13.4		12.0
14.0	13.4	13.6	14.4	15.3	14.4	14.5	14.8	15.0	14.4	13.6	13.5	13.3	12.3	11.2	14.0
16.0	10.5	10.6	11.4	12.2	11.3	11.4	11.7	11.9	11.6	11.7	11.9	12.0	11.3	10.3	16.0
18.0	8.2	8.5	9.2	9.8	9.0	9.1	9.3	9.6	9.2	9.4	9.6	9.8	9.0	9.5	18.0
20.0	6.6	6.7	7.5	8.0	7.2	7.3	7.5	7.8	7.5	7.6	7.8	8.0	7.3	7.8	20.0
22.0	5.2	5.4	6.2	6.7	5.8	6.0	6.2	6.4	6.1	6.2	6.4	6.6	6.0	6.4	22.0
24.0	4.2	4.5	5.1	5.5	4.8	4.9	5.1	5.3	5.0	5.1	5.3	5.5	4.9	5.3	24.0
26.0	3.3	3.6	4.3	4.6	3.9	4.0	4.2	4.4	4.1	4.2	4.4	4.6	4.1	4.4	26.0
28.0	2.7	2.9	3.6	3.9	3.1	3.2	3.4	3.6	3.3	3.5	3.6	3.8	3.4	3.6	28.0
30.0	2.1	2.3	2.9	3.2	2.5	2.6	2.8	3.0	2.7	2.8	3.0	3.2	2.8	3.0	30.0
32.0	1.5	1.7	2.5	2.7	1.9	2.0	2.2	2.4	2.1	2.3	2.5	2.7	2.3	2.4	32.0
34.0	1.1	1.3	2.0	2.2	1.5	1.6	1.7	2.0	1.7	1.8	2.0	2.2	1.8	1.9	34.0
36.0					1.0	1.1	1.3	1.5	1.3	1.4	1.6	1.7	1.4	1.5	36.0
38.0						1.0	1.2		1.0	1.2	1.4	1.0	1.1		38.0
40.0												1.1			40.0
42.0															42.0
44.0															44.0
46.0															46.0
48.0															48.0
50.0															50.0
52.0															52.0
54.0															54.0
No. of line	4	4	4	4	3	3	3	3	3	3	3	3	2	2	No. of line

Unit:t

**Prerequisites:**  
 ① Boom operating conditions(fully extended boom length), max.length is 56m  
 ② The span of outriggers is 7.8m×7.91m  
 ③ 360°rotation is applied  
 ④ Counterweight is 16.5T

Working radius (m)	Main boom (m)												Working radius (m)	
	12.3	16.3			20.4				24.4					
3.0	100.0	85.0	80.0	67.0										3.0
3.5	84.0	80.0	78.0	62.0	73.0	73.0	73.0	48.0	70.0					3.5
4.0	78.0	75.0	70.0	58.0	67.0	67.0	67.0	46.0	65.0	65.0	65.0	49.0	55.0	4.0
4.5	70.0	69.0	64.0	54.0	65.0	65.0	65.0	44.0	60.0	62.0	62.0	46.0	52.0	4.5
5.0	64.0	63.0	60.0	51.0	60.0	60.0	60.0	41.0	56.0	58.0	58.0	45.0	50.0	5.0
6.0	55.0	54.0	54.0	45.0	52.0	52.0	52.0	38.0	50.0	51.0	51.0	41.0	46.0	6.0
7.0	45.0	45.0	45.0	41.0	45.0	45.0	45.0	35.0	45.0	44.0	44.0	37.0	41.0	7.0
8.0	40.0	40.0	40.0	38.0	40.0	40.0	41.0	32.0	40.0	39.0	39.0	34.5	37.0	8.0
9.0	30.0	35.0	35.0	35.0	35.0	35.0	35.5	30.0	36.0	35.0	35.0	32.0	33.0	9.0
10.0		30.0	30.0	30.0	30.0	30.0	31.5	29.0	31.0	31.0	31.5	29.0	30.0	10.0
12.0		22.0	22.0	22.0	22.0	22.0	23.0	24.0	22.0	22.5	23.0	24.0	23.5	12.0
14.0					16.0	17.0	17.0	18.0	17.0	17.0	17.5	19.0	18.1	14.0
16.0						13.0	14.0	15.0	13.0	13.5	13.5	15.5	14.3	16.0
18.0										10.5	11.0	12.5	11.6	18.0
20.0										8.5	9.0	10.5	9.5	20.0
22.0														22.0
24.0														24.0
26.0														26.0
28.0														28.0
30.0														30.0
32.0														32.0
34.0														34.0
36.0														36.0
38.0														38.0
40.0														40.0
42.0														42.0
44.0														44.0
46.0														46.0
48.0														48.0
50.0														50.0
52.0														52.0
54.0														54.0
No. of line	11	11	11	11	10	10	10	10	10	8	8	8	8	No. of line

Unit:t

**Prerequisites:**  
 ① Boom operating conditions(fully extended boom length), max.length is 56m  
 ② The span of outriggers is 7.8m×7.91m  
 ③ 360°rotation is applied  
 ④ Counterweight is 16.5T

Working radius (m)	Main boom (m)												Working radius (m)	
	28.4				32.4				36.5					
3.0														3.0
3.5														3.5
4.0														4.0
4.5	55.0													4.5
5.0	54.0	50.0	50.0	50.0	51.0	45.9	44.0	44.0	35.0					5.0
6.0	50.0	47.0	47.0	47.0	48.0	41.6	41.0	41.0	32.0	34.7	34.7	34.4	31.3	6.0
7.0	45.0	44.0	44.5	44.0	43.5	38.3	37.5	37.5	29.0	31.7	31.7	31.5	29.3	7.0
8.0	40.0	40.0	40.0	40.0	40.0	35.0	35.0	35.0	26.5	29.2	29.2	29.0	27.4	8.0
9.0	36.0	36.0	36.0	36.0	36.0	32.3	33.0	33.0	24.5	27.0	27.0	26.5	26.0	9.0
10.0	32.0	32.5	32.4	33.0	31.8	29.8	30.0	30.0	22.5	24.8	24.8	24.6	24.3	10.0
12.0	23.5	24.0	23.7	24.7	23.1	22.3	23.8	24.1	20.0	21.4	21.4	21.2	22.0	12.0
14.0	18.0	18.5	18.2	19.2	17.7	17.2	18.3	18.6	17.8	18.2	18.5	18.3	18.7	14.0
16.0	14.3	14.8	14.5	15.4	14.0	13.6	14.6	14.9	15.5	14.5	14.8	14.6	14.9	16.0
18.0	11.6	12.0	11.8	12.7	11.3	11.0	11.8	12.2	12.8	11.8	12.1	11.9	12.2	18.0
20.0	9.5	9.9	9.7	10.6	9.2	9.1	9.8	10.1	10.7	9.7	10.0	9.8	10.1	20.0
22.0	7.8	8.3	8.0	8.9	7.6	7.5	8.2	8.5	9.1	8.1	8.4	8.2	8.5	22.0
24.0	6.6	7.0	6.7	7.6	6.3	6.3	6.8	7.2	7.7	6.8	7.1	6.9	7.2	24.0
26.0						5.3	5.8	6.1	6.6	5.7	6.0	5.8	6.1	26.0
28.0						4.4		5.2	5.7	4.8	5.1	4.9	5.2	28.0
30.0										4.0	4.3	4.1	4.4	30.0
32.0														32.0
34.0														34.0
36.0														36.0
38.0														38.0
40.0														40.0
42.0														42.0
44.0														44.0
46.0														46.0
48.0														48.0
50.0														50.0
52.0														52.0
54.0														54.0
No. of line	7	7	7	7	7	6	6	6	5	5	5	5	5	No. of line

Unit:t

**Prerequisites:**  
 ① Boom operating conditions(fully extended boom length), max.length is 56m  
 ② The span of outriggers is 7.8m×7.91m  
 ③ 360°rotation is applied  
 ④ Counterweight is 16.5T

Working radius (m)	Main boom (m)														Working radius (m)
	40.6				44.4				48.4				52.5	56	
3.0															3.0
3.5															3.5
4.0															4.0
4.5															4.5
5.0															5.0
6.0															6.0
7.0															7.0
8.0	25.3	25.2	21.0	21.9											8.0
9.0	23.0	23.0	20.6	20.2	21.4	21.4	20.5	20.3							9.0
10.0	21.5	21.5	19.0	18.9	20.1	20.1	19.2	19.1	18.1	16.6	16.4	16.2			10.0
12.0	19.0	19.0	16.8	16.5	17.8	17.8	17.3	17.2	16.2	14.8	14.8	14.7	13.4		12.0
14.0	16.5	16.5	14.8	15.6	15.9	15.9	15.5	15.5	14.4	13.6	13.5	13.3	12.3	11.2	14.0
16.0	14.5	14.5	13.0	12.9	14.2	14.4	14.0	14.0	13.1	12.4	12.2	12.0	11.3	10.3	16.0
18.0	11.7	12.0	11.7	11.4	12.1	12.2	12.4	12.5	11.9	11.4	11.0	11.1	10.5	9.5	18.0
20.0	9.7	9.9	10.5	10.2	10.0	10.1	10.3	10.5	10.2	10.4	10.2	10.1	9.6	8.8	20.0
22.0	8.1	8.3	9.0	9.2	8.4	8.5	8.7	8.9	8.6	8.7	8.9	9.1	8.9	8.2	22.0
24.0	6.8	7.0	7.7	7.8	7.1	7.2	7.4	7.6	7.3	7.4	7.6	7.8	7.5	7.6	24.0
26.0	5.7	5.9	6.6	6.7	6.0	6.1	6.3	6.5	6.2	6.3	6.5	6.7	6.4	6.5	26.0
28.0	4.8	5.0	5.7	5.8	5.1	5.2	5.4	5.6	5.3	5.4	5.6	5.8	5.5	5.6	28.0
30.0	4.0	4.2	4.9	5.0	4.3	4.4	4.6	4.8	4.5	4.6	4.8	5.0	4.7	4.8	30.0
32.0	3.3	3.5	4.2	4.4	3.6	3.7	3.9	4.1	3.8	4.0	4.1	4.3	4.1	4.1	32.0
34.0	2.7	2.9	3.7	3.8	3.0	3.1	3.3	3.5	3.2	3.4	3.5	3.7	3.5	3.5	34.0
36.0					2.5	2.6	2.8	3.0	2.7	2.9	3.0	3.2	3.0	3.0	36.0
38.0					2.1	2.2	2.4	2.6	2.3	2.4	2.6	2.8	2.5	2.5	38.0
40.0									1.9	2.0	2.2	2.4	2.1	2.1	40.0
42.0									1.5	1.6	1.8	2.0	1.7	1.8	42.0
44.0													1.4	1.4	44.0
46.0													1.1	1.2	46.0
48.0														0.9	48.0
50.0															50.0
52.0															52.0
54.0															54.0
No. of line	4	4	4	4	3	3	3	3	3	3	3	3	2	2	No. of line

Unit:t

**Prerequisites:**  
 ① Boom operating conditions(fully extended boom length), max.length is 56m  
 ② The span of outriggers is 7.8m×7.91m  
 ③ 360°rotation is applied  
 ④ Counterweight is 23.5T

Working radius (m)	Main boom (m)												Working radius (m)	
	12.3	16.3			20.4				24.4					
3.0	100.0	85.0	80.0	67.0										3.0
3.5	84.0	80.0	78.0	62.0	73.0	73.0	73.0	48.0	70.0					3.5
4.0	78.0	75.0	70.0	58.0	67.0	67.0	67.0	46.0	65.0	65.0	65.0	49.0	55.0	4.0
4.5	70.0	69.0	64.0	54.0	65.0	65.0	65.0	44.0	60.0	62.0	62.0	46.0	52.0	4.5
5.0	64.0	63.0	60.0	51.0	60.0	60.0	60.0	41.0	56.0	58.0	58.0	45.0	50.0	5.0
6.0	55.0	54.0	54.0	45.0	52.0	52.0	52.0	38.0	50.0	51.0	51.0	41.0	46.0	6.0
7.0	46.0	46.0	46.0	41.0	45.0	45.0	45.0	35.0	45.0	44.0	44.0	37.0	41.0	7.0
8.0	40.0	40.0	40.0	38.0	40.0	40.5	41.0	32.0	40.0	39.0	39.0	34.5	37.0	8.0
9.0	34.0	35.0	35.0	35.0	35.0	35.5	35.5	30.0	36.0	35.0	35.0	32.0	33.0	9.0
10.0		31.0	31.0	31.0	31.0	31.5	31.5	29.0	30.0	31.5	31.5	29.0	30.0	10.0
12.0		24.0	24.0	25.0	24.5	24.5	25.0	25.0	25.0	26.0	27.4	25.0	25.0	12.0
14.0					20.0	20.5	21.0	22.0	20.0	20.9	21.2	23.0	21.7	14.0
16.0						16.5	17.0	18.0	16.0	16.6	16.9	18.7	17.4	16.0
18.0										13.5	13.8	15.5	14.2	18.0
20.0										11.0	11.4	13.1	11.8	20.0
22.0														22.0
24.0														24.0
26.0														26.0
28.0														28.0
30.0														30.0
32.0														32.0
34.0														34.0
36.0														36.0
38.0														38.0
40.0														40.0
42.0														42.0
44.0														44.0
46.0														46.0
48.0														48.0
50.0														50.0
52.0														52.0
54.0														54.0
No. of line	11	11	11	11	10	10	10	10	10	8	8	8	8	No. of line

Unit:t

- Prerequisites:**  
 ① Boom operating conditions(fully extended boom length), max.length is 56m  
 ② The span of outriggers is 7.8m×7.91m  
 ③ 360°rotation is applied  
 ④ Counterweight is 23.5T

Working radius (m)	Main boom (m)												Working radius (m)	
	28.4				32.4				36.5					
3.0													3.0	
3.5													3.5	
4.0													4.0	
4.5	55.0												4.5	
5.0	54.0	50.0	50.0	50.0	51.0	45.9	44.0	44.0	35.0				5.0	
6.0	50.0	47.0	47.0	47.0	48.0	41.6	41.0	41.0	32.0	34.7	34.7	34.4	31.3	6.0
7.0	45.0	44.0	44.5	44.0	43.5	38.3	37.5	37.5	29.0	31.7	31.7	31.5	29.3	7.0
8.0	40.0	40.0	40.0	40.0	40.0	35.0	35.0	35.0	26.5	29.2	29.2	29.0	27.4	8.0
9.0	36.0	36.0	36.0	36.0	36.0	32.3	33.0	33.0	24.5	27.0	27.0	26.5	26.0	9.0
10.0	32.5	32.5	32.5	32.5	32.5	29.8	30.0	30.0	22.5	24.8	24.8	24.6	24.3	10.0
12.0	26.5	27.0	27.0	27.0	27.0	26.2	25.0	25.0	20.0	21.4	21.4	21.2	22.0	12.0
14.0	21.6	22.1	21.8	22.8	21.3	20.6	19.5	21.0	17.8	18.9	19.0	18.7	20.0	14.0
16.0	17.3	17.8	17.5	18.4	17.0	16.5	17.6	17.9	15.6	16.5	16.8	16.5	17.5	16.0
18.0	14.1	14.6	14.4	15.3	13.9	13.6	14.5	14.8	13.9	14.4	14.7	14.5	14.8	18.0
20.0	11.7	12.2	12.0	12.9	11.5	11.3	12.1	12.4	12.4	12.0	12.3	12.1	12.4	20.0
22.0	9.8	10.4	10.1	11.0	9.7	9.6	10.3	10.5	11.1	10.2	10.4	10.2	10.5	22.0
24.0	8.3	8.8	8.6	9.5	8.2	8.1	8.8	9.0	9.6	8.7	8.9	8.7	9.0	24.0
26.0						6.9	7.5	7.8	8.3	7.4	7.7	7.5	7.8	26.0
28.0						5.9		6.7	7.3	6.4	6.6	6.5	6.7	28.0
30.0										5.5	5.7	5.6	5.9	30.0
32.0														32.0
34.0														34.0
36.0														36.0
38.0														38.0
40.0														40.0
42.0														42.0
44.0														44.0
46.0														46.0
48.0														48.0
50.0														50.0
52.0														52.0
54.0														54.0
No. of line	7	7	7	7	7	6	6	6	5	5	5	5	5	No. of line

Unit:t

- Prerequisites:**  
 ① Boom operating conditions(fully extended boom length), max.length is 56m  
 ② The span of outriggers is 7.8m×7.91m  
 ③ 360°rotation is applied  
 ④ Counterweight is 23.5T

Working radius (m)	Main boom (m)										Working radius (m)				
	40.6		44.4			48.4			52.5	56					
3.0											3.0				
3.5											3.5				
4.0											4.0				
4.5											4.5				
5.0											5.0				
6.0											6.0				
7.0											7.0				
8.0	25.3	25.2	21.0	21.9							8.0				
9.0	23.0	23.0	20.6	20.2	21.4	21.4	20.5	20.3			9.0				
10.0	21.5	21.5	19.0	18.9	20.1	20.1	19.2	19.1	18.1	16.6	16.4	16.2		10.0	
12.0	19.0	19.0	16.8	16.5	17.8	17.8	17.3	17.2	16.2	14.8	14.8	14.7	13.4		12.0
14.0	16.5	16.5	14.8	15.6	15.9	15.9	15.5	15.5	14.4	13.6	13.5	13.3	12.3	11.2	14.0
16.0	14.5	14.5	13.0	12.9	14.2	14.4	14.0	14.0	13.1	12.4	12.2	12.0	11.3	10.3	16.0
18.0	12.5	12.5	11.7	11.4	12.8	12.8	12.7	12.5	11.9	11.4	11.0	11.1	10.5	9.5	18.0
20.0	11.0	10.8	10.5	10.2	11.4	11.6	11.7	11.3	10.7	10.6	10.2	10.1	9.6	8.8	20.0
22.0	9.0	9.0	9.5	9.2	10.4	10.5	10.6	10.4	9.9	9.7	9.4	9.3	8.9	8.2	22.0
24.0	8.6	8.8	8.5	8.2	8.9	9.0	9.2	9.5	9.0	9.0	8.5	8.5	8.2	7.6	24.0
26.0	7.4	7.6	8.0	7.8	7.7	7.8	8.0	8.2	7.9	8.1	8.0	7.9	7.6	7.0	26.0
28.0	6.3	6.5	7.3	7.0	6.6	6.7	6.9	7.1	6.9	7.0	7.2	7.3	7.0	6.5	28.0
30.0	5.5	5.7	6.4	6.5	5.8	5.9	6.1	6.3	6.0	6.1	6.3	6.5	6.2	6.0	30.0
32.0	4.7	4.9	5.6	5.7	5.0	5.1	5.3	5.5	5.2	5.4	5.5	5.7	5.4	5.5	32.0
34.0	4.0	4.2	4.9	5.1	4.3	4.4	4.6	4.8	4.5	4.7	4.8	5.0	4.8	4.8	34.0
36.0					3.7	3.8	4.0	4.2	4.0	4.1	4.3	4.4	4.2	4.2	36.0
38.0					3.2	3.3	3.5	3.7	3.4	3.6	3.7	3.9	3.7	3.7	38.0
40.0									3.0	3.2	3.3	3.5	3.2	3.2	40.0
42.0									2.6	2.7	2.9	3.0	2.8	2.8	42.0
44.0													2.4	2.4	44.0
46.0													2.1	2.1	46.0
48.0													1.8	1.8	48.0
50.0													1.5	1.5	50.0
52.0															52.0
54.0															54.0
No. of line	4	4	4	4	3	3	3	3	3	3	3	3	2	2	No. of line

Unit:t

- Prerequisites:**  
 ① Boom operating conditions(fully extended boom length), max.length is 56m  
 ② The span of outriggers is 5.3m×7.8m  
 ③ 360°rotation is applied  
 ④ Counterweight is 0T

Working radius (m)	Main boom (m)												Working radius (m)	
	12.3	16.3			20.4				24.4					
3.0	100.0	80.0	80.0	67.0										3.0
3.5	84.0	80.0	78.0	62.0	73.0	73.0	73.0	48.0	60.0					3.5
4.0	60.0	58.0	58.0	58.0	58.0	58.0	58.0	46.0	55.0	58.0	58.0	49.0	50.0	4.0
4.5	48.0	45.0	45.0	45.0	42.0	42.0	42.0	40.0	42.0	50.0	50.0	46.0	45.0	4.5
5.0	36.0	36.0	36.5	38.0	36.0	37.0	38.0	38.0	37.2	37.0	37.0	38.0	38.6	5.0
6.0	24.0	24.0	25.0	25.5	23.7	24.4	25.2	26.8	24.5	24.5	24.9	27.6	25.6	6.0
7.0	17.0	17.4	18.0	18.8	16.8	17.4	18.1	19.6	17.5	17.6	18.0	20.3	18.5	7.0
8.0	13.0	13.0	13.7	14.3	12.5	13.1	13.7	15.1	13.2	13.2	13.6	15.7	14.1	8.0
9.0	10.0	10.0	10.7	11.2	9.5	21.8	10.7	12.0	10.1	10.2	10.5	12.5	11.0	9.0
10.0		7.8	8.5	9.0	7.4	7.9	8.5	9.7	8.0	8.0	8.3	10.2	8.8	10.0
12.0		4.8	5.4	5.9	4.4	4.9	5.4	6.6	5.0	5.0	5.3	7.1	5.8	12.0
14.0					2.5	2.9	3.5	4.6	3.0	3.0	3.3	5.1	3.8	14.0
16.0						1.6	2.1	3.1	1.6	1.7	2.0	3.7	2.4	16.0
18.0												2.6	1.4	18.0
20.0												1.8		20.0
22.0														22.0
24.0														24.0
26.0														26.0
28.0														28.0
30.0														30.0
32.0														32.0
34.0														34.0
36.0														36.0
38.0														38.0
40.0														40.0
42.0														42.0
44.0														44.0
46.0														46.0
48.0														48.0
50.0														50.0
52.0														52.0
54.0														54.0
No. of line	11	11	11	11	10	10	10	10	10	8	8	8	8	No. of line

Unit:t

- Prerequisites:**  
 ① Boom operating conditions(fully extended boom length), max.length is 56m  
 ② The span of outriggers is 5.3m×7.8m  
 ③ 360°rotation is applied  
 ④ Counterweight is 0T

Working radius (m)	Main boom (m)												Working radius (m)	
	28.4				32.4				36.5					
3.0														3.0
3.5														3.5
4.0														4.0
4.5														4.5
5.0	38.7	39.0	39.0	40.0	37.9	38.6	39.0	39.0	35.0					5.0
6.0	25.7	26.0	26.0	27.0	25.1	25.6	25.9	26.4	27.4	25.9	26.3	26.0	26.5	6.0
7.0	18.6	19.2	18.8	20.0	18.1	18.5	18.8	19.3	20.1	18.8	19.2	18.9	19.3	7.0
8.0	14.1	14.7	14.3	15.4	13.7	14.1	14.4	14.8	15.5	14.3	14.7	14.4	14.8	8.0
9.0	11.0	11.6	11.3	12.3	10.6	11.0	11.3	11.7	12.4	11.2	11.6	11.3	11.7	9.0
10.0	8.8	9.3	9.0	10.0	8.4	8.8	9.0	9.4	10.1	9.0	9.3	9.1	9.4	10.0
12.0	5.7	6.2	5.9	6.9	5.4	5.8	6.0	6.3	7.0	5.9	6.2	6.0	6.3	12.0
14.0	3.7	4.2	3.9	4.8	3.4	3.8	4.0	4.3	4.9	3.9	4.2	4.0	4.3	14.0
16.0	2.3	2.8	2.5	3.4	2.1	2.4	2.6	2.9	3.5	2.6	2.8	2.6	2.9	16.0
18.0	1.3	1.7	1.5	2.4	1.0	1.4	1.6	1.9	2.5	1.5	1.8	1.6	1.9	18.0
20.0				1.5				1.1	1.6		1.0		1.1	20.0
22.0								1.0						22.0
24.0														24.0
26.0														26.0
28.0														28.0
30.0														30.0
32.0														32.0
34.0														34.0
36.0														36.0
38.0														38.0
40.0														40.0
42.0														42.0
44.0														44.0
46.0														46.0
48.0														48.0
50.0														50.0
52.0														52.0
54.0														54.0
No. of line	7	7	7	7	7	6	6	6	5	5	5	5	5	No. of line

Unit:t

- Prerequisites:**  
 ① Boom operating conditions(fully extended boom length), max.length is 56m  
 ② The span of outriggers is 5.3m×7.8m  
 ③ 360°rotation is applied  
 ④ Counterweight is 0T

Working radius (m)	Main boom (m)														Working radius (m)
	40.6				44.4				48.4				52.5	56	
3.0															3.0
3.5															3.5
4.0															4.0
4.5															4.5
5.0															5.0
6.0															6.0
7.0															7.0
8.0	14.2	14.5	15.5	15.7											8.0
9.0	11.2	11.4	12.4	12.5	21.4	11.7	11.9	12.2							9.0
10.0	8.9	9.2	10.1	10.2	19.2	9.4	9.7	9.9	9.6	9.7	9.0	10.2			10.0
12.0	5.9	6.1	7.0	7.1	13.2	6.3	6.6	6.8	6.5	6.6	6.8	7.1	6.8		12.0
14.0	3.9	4.1	4.9	5.1	9.6	4.3	4.6	15.0	4.5	4.6	4.8	5.0	4.8	4.8	14.0
16.0	2.5	2.7	3.5	3.6	7.1	2.9	3.1	11.9	3.1	3.2	3.4	3.6	3.3	3.4	16.0
18.0	1.5	1.7	2.5	2.6	5.4	1.9	2.1	9.6	2.0	2.2	2.3	2.5	2.3	2.3	18.0
20.0			1.6	1.8	4.0	1.1	1.3	1.5	1.2	1.3	1.5	1.7	1.5	1.5	20.0
22.0				1.1	2.9							0.9	1.1	0.9	22.0
24.0					2.1										24.0
26.0					1.4										26.0
28.0															28.0
30.0															30.0
32.0															32.0
34.0															34.0
36.0															36.0
38.0															38.0
40.0															40.0
42.0															42.0
44.0															44.0
46.0															46.0
48.0															48.0
50.0															50.0
52.0															52.0
54.0															54.0
No. of line	4	4	4	4	3	3	3	3	3	3	3	3	2	2	No. of line

Unit:t

- Prerequisites:**  
 ① Boom operating conditions(fully extended boom length), max.length is 56m  
 ② The span of outriggers is 5.3m×7.8m  
 ③ 360°rotation is applied  
 ④ Counterweight is 8.5T

Working radius (m)	Main boom (m)												Working radius (m)	
	12.3	16.3			20.4				24.4					
3.0	100.0	80.0	80.0	67.0										3.0
3.5	84.0	80.0	75.0	62.0	70.0	70.0	70.0	48.0	70.0					3.5
4.0	75.0	75.0	70.0	56.0	67.0	67.0	67.0	46.0	65.0	65.0	65.0	49.0	55.0	4.0
4.5	65.0	69.0	64.0	54.0	65.0	65.0	65.0	44.0	60.0	62.0	62.0	46.0	52.0	4.5
5.0	50.0	54.3	55.4	50.0	53.6	54.4	55.4	41.0	54.5	54.5	55.1	45.0	50.0	5.0
6.0	36.5	36.5	37.4	38.1	35.9	36.6	37.4	38.0	36.7	36.7	37.2	39.8	37.9	6.0
7.0	26.8	26.8	27.6	28.2	26.3	26.9	27.6	29.1	27.0	27.1	27.4	29.7	28.0	7.0
8.0	20.0	20.7	21.4	22.0	20.2	20.8	21.4	22.8	20.9	20.9	21.3	23.4	21.8	8.0
9.0	16.0	16.5	17.2	17.7	16.0	16.6	17.2	18.5	16.7	16.7	17.1	19.1	17.5	9.0
10.0		13.4	14.1	14.6	13.0	13.5	14.1	15.3	13.6	13.6	13.9	15.9	14.4	10.0
12.0		9.2	9.8	10.3	8.8	9.3	9.9	11.1	9.4	9.4	9.7	11.5	10.2	12.0
14.0					6.1	6.6	7.1	8.2	6.7	6.7	7.0	8.7	7.4	14.0
16.0						4.7	5.2	6.2	4.7	4.8	5.1	6.8	5.5	16.0
18.0										3.4	3.6	5.3	4.1	18.0
20.0										2.3	2.5	4.2	2.9	20.0
22.0														22.0
24.0														24.0
26.0														26.0
28.0														28.0
30.0														30.0
32.0														32.0
34.0														34.0
36.0														36.0
38.0														38.0
40.0														40.0
42.0														42.0
44.0														44.0
46.0														46.0
48.0														48.0
50.0														50.0
52.0														52.0
54.0														54.0
No. of line	11	11	11	11	10	10	10	10	10	8	8	8	8	No. of line

Unit:t

- Prerequisites:**  
 ① Boom operating conditions(fully extended boom length), max.length is 56m  
 ② The span of outriggers is 5.3m×7.8m  
 ③ 360°rotation is applied  
 ④ Counterweight is 8.5T

Working radius (m)	Main boom (m)												Working radius (m)	
	28.4				32.4				36.5					
3.0													3.0	
3.5													3.5	
4.0													4.0	
4.5	55.0												4.5	
5.0	54.0	50.0	50.0	50.0	51.0	45.9	44.0	44.0	35.0				5.0	
6.0	37.9	38.6	38.2	39.5	37.3	37.8	38.2	38.7	32.0	34.7	34.7	34.4	31.3	6.0
7.0	28.1	28.6	28.3	29.4	27.5	28.0	28.3	28.7	29.0	28.2	28.6	28.3	28.8	7.0
8.0	21.8	22.4	22.1	23.1	21.4	21.8	22.1	22.5	23.3	22.0	22.4	22.2	22.5	8.0
9.0	17.5	18.1	17.8	18.8	17.1	17.5	17.8	18.2	18.9	17.7	18.1	17.8	18.2	9.0
10.0	14.4	14.9	14.6	15.6	14.1	14.5	14.7	15.1	15.7	14.6	14.9	14.7	15.1	10.0
12.0	10.2	10.6	10.4	11.3	9.8	10.2	10.4	10.8	11.4	10.4	10.7	10.5	10.8	12.0
14.0	7.4	7.8	7.6	8.5	7.1	7.4	7.7	8.0	8.6	7.6	7.9	7.7	8.0	14.0
16.0	5.5	5.9	5.6	6.5	5.2	5.5	5.7	6.1	6.6	5.7	5.9	5.8	6.1	16.0
18.0	4.1	4.4	4.2	5.1	3.7	4.1	4.3	4.6	5.2	4.2	4.5	4.3	4.6	18.0
20.0	2.9	3.4	3.1	3.9	2.6	3.0	3.2	3.5	4.1	3.2	3.4	3.3	3.5	20.0
22.0	2.1	2.4	2.2	3.1	1.8	2.1	2.3	2.6	3.2	2.2	2.5	2.3	2.6	22.0
24.0	1.3	1.7	1.5	2.3	1.1	1.4	1.6	1.9	2.4	1.5	1.8	1.6	1.9	24.0
26.0							1.0	1.3	1.8		1.2	1.1	1.3	26.0
28.0									1.3					28.0
30.0														30.0
32.0														32.0
34.0														34.0
36.0														36.0
38.0														38.0
40.0														40.0
42.0														42.0
44.0														44.0
46.0														46.0
48.0														48.0
50.0														50.0
52.0														52.0
54.0														54.0
No. of line	7	7	7	7	7	6	6	6	5	5	5	5	5	No. of line

Unit:t

- Prerequisites:**  
 ① Boom operating conditions(fully extended boom length), max.length is 56m  
 ② The span of outriggers is 5.3m×7.8m  
 ③ 360°rotation is applied  
 ④ Counterweight is 8.5T

Working radius (m)	Main boom (m)										Working radius (m)				
	40.6			44.4			48.4		52.5	56					
3.0											3.0				
3.5											3.5				
4.0											4.0				
4.5											4.5				
5.0											5.0				
6.0											6.0				
7.0											7.0				
8.0	21.9	22.3	23.0	22.9							8.0				
9.0	17.7	17.9	18.9	19.1	18.1	18.2	18.4	18.7			9.0				
10.0	14.6	14.8	15.7	15.8	14.9	15.1	15.3	15.5	15.2	15.4	15.6	15.8	10.0		
12.0	10.3	10.5	11.4	11.5	10.7	10.8	11.0	11.2	10.9	11.1	11.3	11.5	11.2	12.0	
14.0	7.6	7.8	8.6	8.7	7.9	8.0	8.2	15.0	8.1	8.3	8.4	8.7	8.4	14.0	
16.0	5.6	5.8	6.6	6.7	5.9	6.1	6.3	11.9	6.2	6.3	6.5	6.7	6.4	16.0	
18.0	4.2	4.4	5.2	5.3	4.5	4.6	4.8	9.6	4.7	4.9	5.1	5.2	5.0	18.0	
20.0	3.1	3.3	4.1	4.2	3.4	3.5	3.7	3.9	3.6	3.7	3.9	4.1	3.9	20.0	
22.0	2.2	2.4	3.1	3.3	2.5	2.6	2.8	3.1	2.7	2.9	3.1	3.2	3.0	22.0	
24.0	1.5	1.7	2.4	2.5	1.8	1.9	2.1	2.3	2.0	2.1	2.3	2.5	2.2	24.0	
26.0		1.1	1.8	1.9	1.2	1.3	1.5	1.7	1.4	1.5	1.7	1.9	1.6	26.0	
28.0			1.3	1.4			1.0	1.2	0.9	1.1	1.2	1.4	1.1	28.0	
30.0				1.0								1.0		30.0	
32.0														32.0	
34.0														34.0	
36.0														36.0	
38.0														38.0	
40.0														40.0	
42.0														42.0	
44.0														44.0	
46.0														46.0	
48.0														48.0	
50.0														50.0	
52.0														52.0	
54.0														54.0	
No. of line	4	4	4	4	3	3	3	3	3	3	3	3	2	2	No. of line

Unit:t

- Prerequisites:**  
 ① Boom operating conditions(fully extended boom length), max.length is 56m  
 ② The span of outriggers is 5.3m×7.8m  
 ③ 360°rotation is applied  
 ④ Counterweight is 16.5T

Working radius (m)	Main boom (m)												Working radius (m)	
	12.3	16.3			20.4				24.4					
3.0	100.0	85.0	80.0	67.0										3.0
3.5	84.0	80.0	78.0	62.0	73.0	73.0	73.0	48.0	70.0					3.5
4.0	78.0	75.0	70.0	58.0	67.0	67.0	67.0	46.0	65.0	65.0	65.0	49.0	55.0	4.0
4.5	70.0	69.0	64.0	54.0	65.0	65.0	65.0	44.0	60.0	62.0	62.0	46.0	52.0	4.5
5.0	64.0	63.0	60.0	51.0	60.0	60.0	60.0	41.0	56.0	58.0	58.0	45.0	50.0	5.0
6.0	48.0	48.0	48.9	45.0	47.4	48.1	48.0	38.0	48.2	48.2	48.7	41.0	46.0	6.0
7.0	35.7	35.7	36.5	37.1	35.2	35.8	36.5	35.0	35.9	35.9	36.3	37.0	36.9	7.0
8.0	28.0	28.0	28.7	29.2	27.5	28.1	28.7	30.0	28.1	28.1	28.5	30.7	29.1	8.0
9.0	22.0	22.6	23.3	23.8	22.2	22.7	23.3	24.6	22.8	22.8	23.1	25.2	23.7	9.0
10.0		18.7	19.4	19.9	18.3	18.8	19.4	20.6	18.9	18.9	19.2	21.2	19.7	10.0
12.0		13.4	14.0	14.5	13.0	13.5	14.0	15.2	13.5	13.6	13.9	15.7	14.3	12.0
14.0					9.6	10.0	10.5	11.6	10.1	10.1	10.4	12.2	10.9	14.0
16.0						7.6	8.1	9.2	7.7	7.7	8.0	9.7	8.4	16.0
18.0										5.9	6.2	7.8	6.6	18.0
20.0										4.5	4.8	6.4	5.2	20.0
22.0														22.0
24.0														24.0
26.0														26.0
28.0														28.0
30.0														30.0
32.0														32.0
34.0														34.0
36.0														36.0
38.0														38.0
40.0														40.0
42.0														42.0
44.0														44.0
46.0														46.0
48.0														48.0
50.0														50.0
52.0														52.0
54.0														54.0
No. of line	11	11	11	11	10	10	10	10	10	8	8	8	8	No. of line

Unit:t

- Prerequisites:**  
 ① Boom operating conditions(fully extended boom length), max.length is 56m  
 ② The span of outriggers is 5.3m×7.8m  
 ③ 360°rotation is applied  
 ④ Counterweight is 16.5T

Working radius (m)	Main boom (m)												Working radius (m)	
	28.4				32.4				36.5					
3.0														3.0
3.5														3.5
4.0														4.0
4.5	55.0													4.5
5.0	54.0	50.0	50.0	50.0	51.0	45.9	44.0	44.0	35.0					5.0
6.0	49.4	47.0	47.0	47.0	48.0	41.6	41.0	41.0	32.0	34.7	34.7	34.4	31.3	6.0
7.0	36.9	37.5	37.2	38.3	36.4	36.9	37.2	37.5	29.0	31.7	31.7	31.5	29.3	7.0
8.0	29.1	29.6	29.3	30.4	28.6	29.0	29.3	29.7	26.5	29.2	29.2	29.0	27.4	8.0
9.0	23.6	24.2	23.9	24.9	23.2	23.6	23.9	24.3	24.5	23.8	24.2	23.9	24.3	9.0
10.0	19.7	20.2	20.0	20.9	19.3	19.7	20.0	20.3	21.0	19.9	20.2	20.0	20.3	10.0
12.0	14.3	14.8	14.5	15.5	14.0	14.3	14.6	14.9	15.6	14.5	14.8	14.6	14.9	12.0
14.0	10.8	11.3	11.0	11.9	10.5	10.9	11.1	11.4	12.0	11.0	11.3	11.1	11.4	14.0
16.0	8.4	8.8	8.6	9.4	8.1	8.4	8.6	9.0	9.6	8.6	8.9	8.7	9.0	16.0
18.0	6.6	7.0	6.7	7.6	6.3	6.6	6.8	7.1	7.7	6.8	7.0	6.9	7.1	18.0
20.0	5.2	5.6	5.3	6.2	4.9	5.2	5.4	5.7	6.3	5.4	5.6	5.5	5.7	20.0
22.0	4.0	4.5	4.2	5.1	3.8	4.1	4.3	4.6	5.2	4.3	4.5	4.3	4.6	22.0
24.0	3.1	3.5	3.3	4.2	2.9	3.2	3.5	3.7	4.3	3.4	3.6	3.4	3.7	24.0
26.0						2.5	2.7	3.0	3.5	2.6	2.9	2.7	3.0	26.0
28.0						1.8		2.3	2.9	2.0	2.2	2.1	2.3	28.0
30.0										1.4	1.7	1.5	1.8	30.0
32.0														32.0
34.0														34.0
36.0														36.0
38.0														38.0
40.0														40.0
42.0														42.0
44.0														44.0
46.0														46.0
48.0														48.0
50.0														50.0
52.0														52.0
54.0														54.0
No. of line	7	7	7	7	7	6	6	6	5	5	5	5	5	No. of line



Unit:t

- Prerequisites:**  
 ① Boom operating conditions(fully extended boom length), max.length is 56m  
 ② The span of outriggers is 5.3m×7.8m  
 ③ 360°rotation is applied  
 ④ Counterweight is 16.5T

Working radius (m)	Main boom (m)														Working radius (m)
	40.6				44.4				48.4				52.5	56	
3.0															3.0
3.5															3.5
4.0															4.0
4.5															4.5
5.0															5.0
6.0															6.0
7.0															7.0
8.0	25.3	25.2	21.0	21.9											8.0
9.0	23.0	23.0	20.6	20.2	21.4	21.4	20.5	20.3							9.0
10.0	19.8	20.1	19.0	18.9	20.1	20.1	19.2	19.1	18.1	16.6	16.4	16.2			10.0
12.0	14.5	14.7	15.5	15.7	14.8	14.9	15.2	15.4	15.1	14.8	14.8	14.7	13.4		12.0
14.0	11.0	11.2	12.0	12.1	11.3	11.4	11.6	11.9	11.5	11.7	11.9	12.1	11.8	11.2	14.0
16.0	8.5	8.8	9.5	9.7	8.9	9.0	9.2	9.4	9.1	9.3	9.4	9.6	9.4	9.4	16.0
18.0	6.7	6.9	7.7	7.8	7.0	7.2	7.3	7.6	7.3	7.4	7.6	7.8	7.5	7.6	18.0
20.0	5.3	5.5	6.3	6.4	5.6	5.7	5.9	6.2	5.8	6.0	6.2	6.4	6.1	6.1	20.0
22.0	4.2	4.4	5.2	5.3	4.5	4.6	4.8	5.0	4.7	4.9	5.0	5.2	5.0	5.0	22.0
24.0	3.3	3.5	4.2	4.4	3.6	3.7	3.9	4.1	3.8	4.0	4.1	4.3	4.1	4.1	24.0
26.0	2.6	2.8	3.5	3.6	2.9	3.0	3.2	3.4	3.1	3.2	3.4	3.6	3.3	3.3	26.0
28.0	1.9	2.1	2.8	3.0	2.2	2.3	2.5	2.7	2.4	2.6	2.7	2.9	2.7	2.7	28.0
30.0	1.4	1.6	2.3	2.4	1.7	1.8	2.0	2.2	1.9	2.0	2.2	2.4	2.1	2.2	30.0
32.0		1.1	1.8	1.9	1.2	1.3	1.5	1.7	1.4	1.6	1.7	1.9	1.7	1.7	32.0
34.0			1.4	1.5			1.1	1.3	1.0	1.1	1.3	1.5	1.2	1.3	34.0
36.0										1.0	1.1	0.9	0.9		36.0
38.0															38.0
40.0															40.0
42.0															42.0
44.0															44.0
46.0															46.0
48.0															48.0
50.0															50.0
52.0															52.0
54.0															54.0
No. of line	4	4	4	4	3	3	3	3	3	3	3	3	2	2	No. of line

Unit:t

- Prerequisites:**  
 ① Boom operating conditions(fully extended boom length), max.length is 56m  
 ② The span of outriggers is 5.3m×7.8m  
 ③ 360°rotation is applied  
 ④ Counterweight is 23.5T

Working radius (m)	Main boom (m)												Working radius (m)	
	12.3	16.3			20.4				24.4					
3.0	100.0	85.0	80.0	67.0										3.0
3.5	84.0	80.0	78.0	62.0	73.0	73.0	73.0	48.0	70.0					3.5
4.0	78.0	75.0	70.0	58.0	67.0	67.0	67.0	46.0	65.0	65.0	65.0	49.0	55.0	4.0
4.5	70.0	69.0	64.0	54.0	65.0	65.0	65.0	44.0	60.0	62.0	62.0	46.0	52.0	4.5
5.0	64.0	63.0	60.0	51.0	60.0	60.0	60.0	41.0	56.0	58.0	58.0	45.0	50.0	5.0
6.0	55.0	54.0	54.0	45.0	52.0	52.0	52.0	38.0	50.0	51.0	51.0	41.0	46.0	6.0
7.0	43.5	43.0	44.0	41.0	43.0	43.6	44.0	35.0	43.7	43.7	44.0	37.0	41.0	7.0
8.0	34.4	34.0	35.0	35.0	33.8	34.4	35.0	32.0	34.5	34.5	34.8	34.5	35.4	8.0
9.0	28.1	28.0	28.0	29.0	27.5	28.0	28.6	29.9	28.1	28.1	28.5	30.6	29.0	9.0
10.0		23.0	24.0	24.0	22.9	23.4	24.0	25.2	23.5	23.5	23.8	25.8	24.3	10.0
12.0		17.0	17.5	18.0	16.6	17.1	17.7	18.8	17.2	17.2	17.5	19.4	18.0	12.0
14.0					12.6	13.0	13.5	14.6	13.1	13.1	13.4	15.2	13.9	14.0
16.0						10.1	10.7	11.7	10.2	10.3	10.6	12.3	11.0	16.0
18.0										8.1	8.4	10.1	8.8	18.0
20.0										6.5	6.7	8.4	7.2	20.0
22.0														22.0
24.0														24.0
26.0														26.0
28.0														28.0
30.0														30.0
32.0														32.0
34.0														34.0
36.0														36.0
38.0														38.0
40.0														40.0
42.0														42.0
44.0														44.0
46.0														46.0
48.0														48.0
50.0														50.0
52.0														52.0
54.0														54.0
No. of line	11	11	11	11	10	10	10	10	10	8	8	8	8	No. of line

Unit:t

- Prerequisites:**  
 ① Boom operating conditions(fully extended boom length), max.length is 56m  
 ② The span of outriggers is 5.3m×7.8m  
 ③ 360°rotation is applied  
 ④ Counterweight is 23.5T

Working radius (m)	Main boom (m)												Working radius (m)	
	28.4				32.4				36.5					
3.0													3.0	
3.5													3.5	
4.0													4.0	
4.5	55.0												4.5	
5.0	54.0	50.0	50.0	50.0	51.0	45.9	44.0	44.0	35.0				5.0	
6.0	50.0	47.0	47.0	47.0	48.0	41.6	41.0	41.0	32.0	34.7	34.7	34.4	31.3	6.0
7.0	44.7	44.0	44.5	44.0	43.5	38.3	37.5	37.5	29.0	31.7	31.7	31.5	29.3	7.0
8.0	35.4	36.0	35.6	36.7	34.9	35.0	35.0	35.0	26.5	29.2	29.2	29.0	27.4	8.0
9.0	29.0	29.5	29.2	30.2	28.6	29.0	29.3	29.7	24.5	27.0	27.0	26.5	26.0	9.0
10.0	24.3	24.8	24.5	25.5	23.9	24.3	24.6	25.0	22.5	24.5	24.8	24.6	24.3	10.0
12.0	18.0	18.4	18.2	19.1	17.6	18.0	18.2	18.6	19.2	18.2	18.5	18.3	18.6	12.0
14.0	13.8	14.3	14.0	14.9	13.5	13.9	14.1	14.4	15.0	14.0	14.3	14.1	14.4	14.0
16.0	10.9	11.4	11.1	12.0	10.7	11.0	11.2	11.5	12.1	11.1	11.4	11.2	11.5	16.0
18.0	8.8	9.2	9.0	9.8	8.5	8.8	9.0	9.4	9.9	9.0	9.3	9.1	9.4	18.0
20.0	7.1	7.5	7.3	8.2	6.8	7.2	7.4	7.7	8.3	7.3	7.6	7.4	7.7	20.0
22.0	5.8	6.2	6.0	6.8	5.5	5.9	6.1	6.4	6.9	6.0	6.3	6.1	6.4	22.0
24.0	4.7	5.1	4.9	5.7	4.5	4.8	5.1	5.3	5.9	5.0	5.2	5.0	5.3	24.0
26.0						3.9	4.1	4.4	5.0	4.1	4.3	4.2	4.4	26.0
28.0						3.2		3.7	4.2	3.3	3.6	3.4	3.7	28.0
30.0										2.7	2.9	2.8	3.0	30.0
32.0														32.0
34.0														34.0
36.0														36.0
38.0														38.0
40.0														40.0
42.0														42.0
44.0														44.0
46.0														46.0
48.0														48.0
50.0														50.0
52.0														52.0
54.0														54.0
No. of line	7	7	7	7	7	6	6	6	5	5	5	5	5	No. of line

Unit:t

- Prerequisites:**  
 ① Boom operating conditions(fully extended boom length), max.length is 56m  
 ② The span of outriggers is 5.3m×7.8m  
 ③ 360°rotation is applied  
 ④ Counterweight is 23.5T

Working radius (m)	Main boom (m)										Working radius (m)				
	40.6		44.4			48.4			52.5	56					
3.0											3.0				
3.5											3.5				
4.0											4.0				
4.5											4.5				
5.0											5.0				
6.0											6.0				
7.0											7.0				
8.0	25.3	25.2	21.0	21.9							8.0				
9.0	23.0	23.0	20.6	20.2	21.4	21.4	20.5	20.3			9.0				
10.0	21.5	21.5	19.0	18.9	20.1	20.1	19.2	19.1	18.1	16.6	16.4	16.2		10.0	
12.0	18.1	18.3	16.8	16.5	17.8	17.8	17.3	17.2	16.2	14.8	14.8	14.7	13.4		12.0
14.0	14.0	14.2	14.8	15.1	14.3	14.4	14.0	14.9	14.4	13.6	13.5	13.3	12.3	11.2	14.0
16.0	11.1	11.3	12.1	12.2	11.4	11.5	11.7	12.0	11.6	11.8	12.0	12.0	11.3	10.3	16.0
18.0	8.9	9.2	9.9	10.0	9.3	9.4	9.6	9.8	9.5	9.6	9.8	10.0	9.7	9.5	18.0
20.0	7.3	7.5	8.3	8.4	7.6	7.7	7.9	8.1	7.8	8.0	8.1	8.3	8.1	8.1	20.0
22.0	6.0	6.2	6.9	7.0	6.3	6.4	6.6	6.8	6.5	6.6	6.8	7.0	6.7	6.8	22.0
24.0	4.9	5.1	5.8	6.0	5.2	5.3	5.5	5.7	5.4	5.6	5.7	5.9	5.7	5.7	24.0
26.0	4.0	4.2	4.9	5.1	4.4	4.4	4.6	4.8	4.5	4.7	4.8	5.0	4.8	4.8	26.0
28.0	3.3	3.5	4.2	4.3	3.6	3.7	3.9	4.1	3.8	3.9	4.1	4.3	4.0	4.1	28.0
30.0	2.6	2.8	3.5	3.7	3.0	3.1	3.2	3.4	3.2	3.3	3.4	3.6	3.4	3.4	30.0
32.0	2.1	2.3	3.0	3.1	2.4	2.5	2.7	2.9	2.6	2.7	2.9	3.1	2.8	2.9	32.0
34.0	1.6	1.8	2.5	2.6	1.9	2.0	2.2	2.4	2.1	2.2	2.4	2.6	2.3	2.4	34.0
36.0					1.5	1.6	1.8	2.0	1.7	1.8	2.0	2.2	1.9	1.9	36.0
38.0					1.1	1.2	1.4	1.6	1.3	1.4	1.6	1.8	1.5	1.6	38.0
40.0									1.0	1.1	1.3	1.4	1.2	1.2	40.0
42.0											1.0	1.1	0.9	0.9	42.0
44.0															44.0
46.0															46.0
48.0															48.0
50.0															50.0
52.0															52.0
54.0															54.0
No. of line	4	4	4	4	3	3	3	3	3	3	3	3	2	2	No. of line

## Prerequisites:

- ① Boom + jib (52.5m+9.5/15.5/21.5m)
- ② The span of outriggers is 7.8m×7.91m
- ③ 360°rotation is applied
- ④ Counterweight is 23.5T

Working radius (m)	Boom length:52.5m									Working radius (m)
	9.5m			15.5m			21.5m			
	0°	15°	30°	0°	15°	30°	0°	15°	30°	
10.0	6.5									10.0
11.0	6.5			5.0						11.0
12.0	6.5	4.5		5.0			3.8			12.0
14.0	6.2	4.5	3.4	4.9	3.5		3.8			14.0
16.0	5.7	4.4	3.2	4.8	3.5		3.5			16.0
18.0	5.5	4.3	3.1	4.6	3.5	2.5	3.2	2.5		18.0
20.0	5.3	4.2	3.0	4.5	3.5	2.5	3.0	2.4		20.0
22.0	5.2	4.0	2.9	4.4	3.5	2.5	2.8	2.3	1.5	22.0
24.0	4.9	3.9	2.9	4.1	3.4	2.5	2.6	2.2	1.5	24.0
26.0	4.5	3.7	2.8	3.8	3.3	2.4	2.4	2.1	1.5	26.0
28.0	4.2	3.6	2.8	3.5	3.1	2.3	2.3	2.1	1.5	28.0
30.0	3.5	3.5	2.7	3.4	2.9	2.3	2.2	2.0	1.5	30.0
32.0	3.4	3.2	2.6	3.2	2.8	2.2	2.2	1.9	1.5	32.0
34.0	3.0	3.0	2.6	3.1	2.6	2.1	2.1	1.8	1.5	34.0
36.0	2.7	2.6	2.5	3.0	2.5	2.0	2.0	1.8	1.4	36.0
38.0	2.5	2.5	2.4	2.9	2.4	1.9	1.9	1.7	1.4	38.0
40.0	2.2	2.3	2.1	2.7	2.3	1.8	1.8	1.6	1.4	40.0
42.0	1.9	2.1	1.8	2.4	2.2	1.8	1.6	1.5	1.4	42.0
44.0		1.7	1.6	2.1	2.0	1.7	1.5	1.5	1.3	44.0
46.0				1.9	1.8	1.6	1.4	1.4	1.3	46.0
48.0					1.6	1.5	1.4	1.3	1.2	48.0
50.0						1.2	1.1	1.1	1.1	50.0
52.0								1.1	0.9	52.0
54.0								0.9	0.9	54.0
56.0									0.8	56.0

## Prerequisites:

- ① Boom + jib (56m+9.5/15.5/21.5m)
- ② The span of outriggers is 7.8m×7.91m
- ③ 360°rotation is applied
- ④ Counterweight is 23.5T

Working radius (m)	Boom length:56m									Working radius (m)
	9.5m			15.5m			21.5m			
	0°	15°	30°	0°	15°	30°	0°	15°	30°	
10	6.5									10
11	6.5									11
12	6.5	4.5								12
14	6.5	4.5		5.0			3.8			14
16	6.2	4.5	3.1	4.7	3.5		3.8			16
18	5.8	4.5	3.1	4.6	3.5	2.5	3.6	2.5		18
20	5.6	4.3	3.0	4.5	3.5	2.5	3.2	2.5		20
22	5.4	4.1	2.9	4.3	3.5	2.5	2.9	2.5	1.5	22
24	5.2	4.0	2.8	4.1	3.4	2.5	2.7	2.3	1.5	24
26	4.9	3.9	2.8	3.7	3.2	2.3	2.5	2.2	1.5	26
28	4.5	3.7	2.7	3.5	3.0	2.2	2.4	2.1	1.5	28
30	4.2	3.6	2.6	3.3	2.7	2.1	2.2	2.1	1.5	30
32	3.6	3.4	2.6	3.2	2.6	2.0	2.1	2.0	1.5	32
34	3.3	3.2	2.5	3.0	2.6	2.0	2.0	1.9	1.5	34
36	3.1	3.0	2.5	3.0	2.4	1.9	2.0	1.8	1.5	36
38	2.7	2.7	2.3	2.8	2.3	1.8	1.9	1.8	1.4	38
40	2.5	2.4	2.1	2.6	2.2	1.7	1.8	1.7	1.4	40
42	2.2	2.1	1.8	2.2	2.1	1.6	1.8	1.6	1.4	42
44	1.9	1.8	1.6	2.0	2.0	1.5	1.6	1.5	1.4	44
46		1.7	1.4	1.8	1.7	1.5	1.5	1.5	1.3	46
48				1.5	1.5	1.4	1.4	1.4	1.3	48
50					1.2	1.2	1.4	1.2	1.2	50
52						1.0	1.0	1.1	1.1	52
54								1.0	1.0	54
56								0.9	0.9	56
58									0.8	58

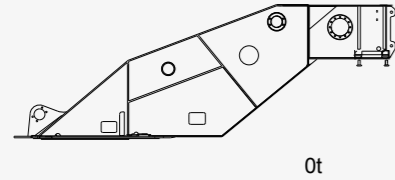

0t

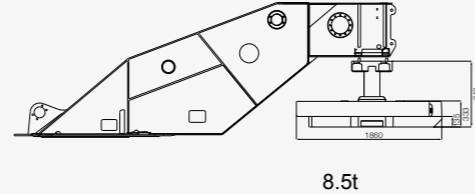

8.5t

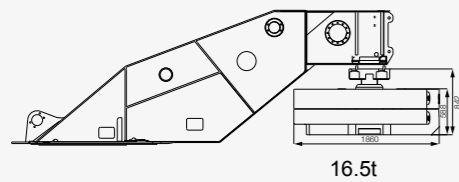



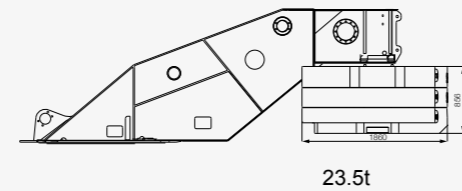



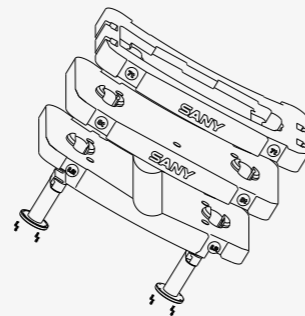
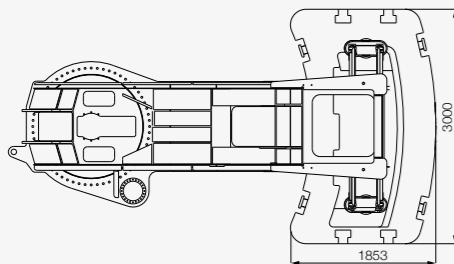











16.5t



23.5t



TRUCK CRANE

 STC200 Maximum Load Capacity: 20t Telescopic Boom: 4 Sections, 10.6-33m	 STC250 Maximum Load Capacity: 25t Telescopic Boom: 4 Sections, 10.65-33.5m	 STC250H Maximum Load Capacity: 25t Telescopic Boom: 5 Sections, 10.5-39.5m	 STC300S Maximum Load Capacity: 30t Telescopic Boom: 5 Sections, 10.6-40.5m	 STC300TH Maximum Load Capacity: 30t Telescopic Boom: 4 Sections, 10.6-33.5m
 STC300H Maximum Load Capacity: 30t Telescopic Boom: 5 Sections, 10.5-39.5m	 STC500 Maximum Load Capacity: 50t Telescopic Boom: 5 Sections, 11.5-43m	 STC550 Maximum Load Capacity: 55t Telescopic Boom: 5 Sections, 11.5-43m	 STC600S Maximum Load Capacity: 60t Telescopic Boom: 5 Sections, 11.3-43.5m	 STC750 Maximum Load Capacity: 75t Telescopic Boom: 5 Sections, 11.8-48m
 STC800S Maximum Load Capacity: 80t Telescopic Boom: 5 Sections, 12.2-47m	 STC1000 Maximum Load Capacity: 100t Telescopic Boom: 5 Sections, 13.5-52m	 STC1000C Maximum Load Capacity: 100t Telescopic Boom: 6 Sections, 13.25-60m	 STC1000S Maximum Load Capacity: 100t Telescopic Boom: 5 Sections, 12.26-56m	 STC1200S Maximum Load Capacity: 120t Telescopic Boom: 7 Sections, 12.6-63.5m
 STC1300C Maximum Load Capacity: 130t Telescopic Boom: 6 Sections, 13.3-69m	 STC1600 Maximum Load Capacity: 160t Telescopic Boom: 6 Sections, 13.4-69m	 STC2200 Maximum Load Capacity: 220t Telescopic Boom: 6 Sections, 14.55-68m		

ALL TERRAIN CRANE

 SAC1800 Maximum Load Capacity: 180t Telescopic Boom: 6 Sections, 15.5-62m	 SAC2200 Maximum Load Capacity: 220t Telescopic Boom: 6 Sections, 13.5-62m	 SAC2600 Maximum Load Capacity: 260t Telescopic Boom: 6 Sections, 15.65-73m	 SAC3000 Maximum Load Capacity: 300t Telescopic Boom: 7 Sections, 15.4-83m
 SAC3500 Maximum Load Capacity: 350t Telescopic Boom: 6 Sections, 15.2-70m	 SAC6000 Maximum Load Capacity: 600t Telescopic Boom: 7 Sections, 17.1-90m		

ROUGH-TERRAIN CRANE

 SRC250 Maximum Load Capacity: 25t Telescopic Boom: 4 Sections, 9.9-31.5m	 SRC350 Maximum Load Capacity: 35t Telescopic Boom: 4 Sections, 10-31.5m	 SRC650 Maximum Load Capacity: 65t Telescopic Boom: 4 Sections, 11.25-34.5m	 SRC660H Maximum Load Capacity: 66t Telescopic Boom: 5 Sections, 11.5-43m	 SRC750 Maximum Load Capacity: 75t Telescopic Boom: 5 Sections, 11.8-45m
 SRC1200 Maximum Load Capacity: 120t Telescopic Boom: 5 Sections, 13-49m				



Quality Changes the World

## SANY AUTOMOBILE HOISTING MACHINERY

Address: SANY Industrial Park, Jinzhou Development Zone,  
Changsha, Hunan, China.  
Service Hotline: 4006098318  
Email: [crd@sany.com.cn](mailto:crd@sany.com.cn)  
For more information, please visit: [www.sanygroup.com](http://www.sanygroup.com)

For our consistent improvement in technology, specifications may change without notice.  
The machines illustrated may show optional equipment which can be supplied at additional cost.

Version: 2015.08

Distributed By:

--