



# SCC800A

## Crawler Crane

### 80 Tons Lifting Capacity

Quality Changes the World



Max. lifting moment: 350t·m  
Max. boom length: 57m  
Max. fixed jib combination: 48m+18m

■ [www.sany.com.cn](http://www.sany.com.cn)



## Crawler Crane Series SCC800A

P03

Main  
Characteristics

- Product Specification
- Safety Device

P09

Technical  
Parameters

- Major Performance & Specifications
- Outline Dimension
- Transport Dimension
- Transport Plan

P19

Cofigurations

- H Configuration
- FJ Configuration



**SCC800A**  
**SANY CRAWLER CRANE**  
**80 TONS LIFTING CAPACITY**

QUALITY CHANGES THE WORLD

## Main Characteristics

- Page 04 Product Specification
- Page 07 Safety Device

> 03



## Product Specification

### Engine

- Model: ISUZU 6HK1 Diesel engine;
- Type: 4-stroke, water-cooled, vertical in-line 6 cylinders, direct injection, turbo-charger, intercooler, complied with European Off-way Tier III Emission Standard and Chinese Off-way Tier III Emission Standard;
- Displacement: 7.79L;
- Rated power: 212kW/2000rpm;
- Operation power: 200kW/1800rpm;
- Max. Torque: 1080N·m/1500rpm;
- Starter: 24V-5.0kW;
- Radiator: fin type aluminum plate core;
- Air cleaner: Dry type system with main filter element, safety element and resistance indicator;
- Throttle: Grip type hand throttle, electrically-controlled;
- Fuel filter: Replaceable paper element;
- Batteries: Two 12V×180Ah capacity batteries, connected in series;
- Fuel tank capacity: 400L.

### Electrical Control System

- Self-developed SYIC-II integrated control system is adopted with higher integration, precise operation and reliable quality;
- Control system consists of power system, engine system, main control system, LMI system, auxiliary system and safety monitoring system. CAN BUS is used for data communication between controller, monitor and the engine;
- Monitor: the working parameters and status are shown on the monitor, such as the engine speed, fuel volume, engine oil pressure, servo pressure, wind speed, engine working hours, lifting conditions and boom angle.

### Hydraulic System

- Main pumps: three open variable displacement piston pumps are adopted to provide oil supply for main actuators of main machine;
- Gear pump: two types of gear pump for radiator and control circuit;
- Control: main pump adopts electrically-controlled positive flow control; winch motor adopts limitless adjustable piston motor of variable displacement. The operating components are three parallel hydraulic handles, one dual handle for travel and one cross hydraulic handle, to control various actuators proportionally;
- Way of cooling: heat exchanger, fan core and multi-stage cooling;
- Filter: large flow, high precision filter, with bypass valve and transmitter, which can remind the user to replace the filter element in time;
- Max. pressure of system: 32MPa;
- Main/aux. load hoist and travel system: 32MPa;
- Swing system: 32MPa;
- Control system: 5MPa;
- Hydraulic Tank Capacity: 460L.

### Main and Aux. Hoist Mechanism

- Main and aux. hoist winches are driven separately by motor via gearbox. Operating winch handle can control the winch to rotate to two directions, which are lifting and lowering of hook. Excellent inching function is equipped on the machine;
- Drums with fold-line grooves can ensure the wire rope reeved in order in multilayers;
- Free fall for main/aux. load hoist is offered as optional.

Main Hoisting Mechanism	Drum diameter	630mm
	Rope speed on the outermost work layer	0~121m/min
	Wire rope diameter	Φ26mm
	Wire rope length of main hoist	240m
	Rated single line pull	12t
Auxiliary Hoisting Mechanism	Drum diameter	630mm
	Rope speed on the outermost work layer	0~121m/min
	Wire rope diameter	Φ26mm
	Wire rope length of auxiliary hoist	180m
	Rated single line pull	12t



## Product Specification

### Boom Hoist Mechanism

- Boom hoist winches is driven separately by motor via gearbox. Operating winch handle can control the winch to rotate to two directions, which are lifting and lowering of boom;
- Drums with fold-line grooves can ensure the wire rope reeved in order in multilayers.

Boom hoist mechanism	Drum diameter	400mm
	Rope speed on the outermost work layer	0~59m/min
	Wire rope diameter	Φ20mm
	Wire rope length of main luffing	140m
	Rated single line pull	7t

### Swing Mechanism

- Swing brake adopts wet, spring loaded, normally-closed brake, and braking through spring force;
- Swing system has three work modes to accommodate different needs. It is featured in small backlash, steady control, and excellent inching function. It also has free slipping function and swing control on slope to avoid sudden braking;
- Swing drive: internal engaged swing drive with 360° swing range, and the max. swing speed is 2.7r/min. The max. drive pressure can reach 32MPa;
- Swing lock: cylinder lock can ensure the upperworks locked securely on four directions after work or during transport;
- Swing ring: single row ball bearing.

### Cab and Control

- Novel operator's cab with fashionable profile and nice interior. There are low and high-beam lights, back-view mirror, heater and A/C, radio and other functions. The layout of seat, handles, control buttons are designed with ergonomic principles to make operation more comfortable;
- Cab layout: Integrated 10.4-inch touch screen, programmable smart switches, vibration handles are offered as optional and man-machine interaction interface are more perfect;
- Armrest box: on the left and right armrest box are control handles, electrical switches, emergent stop and ignition switch. The armrest box can be adjusted along with the seat;
- Seat: multi-way and multi-level floating adjustable seat with unload switch;
- A/C: cool and heat air; optimized air channels and vents;
- Multiple cameras can present on the monitor at the same time to realize backing video, real-time monitoring of wire rope on each winch, conditions behind the counterweight and surrounding the machine.

### Counterweight

- Counterweight tray and blocks are piled up for easier assembly and transport;
- Rear counterweight: total 27.6t. There is normal rear counterweight (standard offering) and self-assembled counterweight (optional offering);
- Normal counterweight: tray 8.26t×1, left counterweight block 3t×2, right counterweight block 3t×2, left counterweight block 3.68t×1, and right counterweight block 3.68t×1;
- Optional self-assembled counterweight: tray 8.7t×1, left counterweight block 3.16t×3, and right counterweight block 3.16t×3, cylinder bracket 0.6x1;
- Carbody counterweight: 2t×2 at the front and rear of carbody.

### Upperworks

- High-strength steel weld framework, with no torsion or deformation. The parts are laid out in the way that is easier for maintenance and service.



## Product Specification

### Lowerworks

- Independent travel driving units are adopted for each side of the crawler, to realize straight walking and turning driven by travel motor through gearbox and drive wheel.

### Crawler Extension and Retraction

- The crawlers can extend and retract via cylinders. During Work Mode, the crawlers must be extended, and retracted during transport with crawlers on.

### Crawler Tensioning

- The jack is used to push the guide wheel and insert the shim to adjust crawler tension.

### Track Pad

- High-strength alloy cast steel track pad can prolong the service life. They are 850mm wide, and the total amount is 52pcs x 2.

### Outrigger

- Outrigger cylinder is offered as optional to facilitate the track frame disassembly during jobsite transfer.

### Operating Equipment

- All chords are high-strength steel tubes, and the boom/jib top sheaves are made of high-strength anti-wearing Nylon material protecting wire rope. The hooks are installed with milled welded steel sheave. Pendant cables with quick hitch connector that are easy to assemble are offered as options.

### Boom

- Lattice structure. The chord adopts high-strength structural tube and each section is connected through pins;
- Basic boom: 6m boom top + 6m boom base;
- Boom insert: 3m×1, 6m×1, 9m×4;
- Boom length: 12m~57m.

### Fixed Jib

- Lattice structure. The chord adopts high-strength structural tube and each section is connected through pins;
- Basic jib: 4.5m jib top + 4.5m jib base;
- Jib insert: 4.5m x 2;
- Jib length: 9m~18m;
- Longest boom + jib: 48m boom +18m jib.

### Extension Jib

- The extension jib is a welded structure connected to the boom tip by pins, used for auxiliary hook;
- Extension jib length: 1.2m.

### Hook Block

- 100t hook block, five sheaves;
- 50t hook block, three sheaves;
- 25t hook block, one sheave;
- 13.50t ball hook.



## Safety Device

### Assembly Mode/Work Mode Switch

- In Assembly Mode, the over-hoist protection, boom limit, LML are all off work to facilitate crane assembly;
- In Work Mode, all safety devices activate to protect the operation.

### Emergent Stop

- In emergent situation, this button is pressed down to cut off the power supply of whole machine and all actions stop.

### Load Moment Limiter (LML)

- It is an independent computerized safety control system. LML can automatically detect the load weight, work radius and boom angle, and present on the display the rated load, actual load, work radius and boom angle. In normal operation, the LML can make a judgment and cut off automatically if the crane moves towards dangerous direction. It can also perform as a black box to record the lifting information.

### Over-hoist limit of the Main/ Auxiliary Hooks

- Over-hoist protection device comprises of limit switch and weight on boom top, which prevents the hook lift up too much. When the hook lifts up to the limit height, the limit switch activates, buzzer on the left control panel sends alarm, and failure indicator light starts to flash, the hook hoisting action is cut off automatically.

### Over-release limit of the Main/Auxiliary Winch

- It is comprised of actuator in the drum and proximity switch to prevent over release of wire rope. When the rope is paid out close to the last three wraps, the proximity switch acts, and the system sends alarm through buzzer and show the alarm on the monitor, automatically cutting off the winch action.

### Function Lock

- If the function lock lever is not in work position, all the other handles won't work, which prevents any mis-operation caused by accidental collision.

### Boom Hoist Drum Lock

- Hydraulically controlled lock is installed for boom hoist drum, which needs to unlock by switch before operation, in order to prevent mis-operation of handles and ensure safety during non-work time.

### Swing Lock

- Swing Lock can lock the machine at four positions, front and back, left and right.

### Boom Limit Device

- When the boom elevation angle reaches the max. set limit, the buzzer sounds and boom action cut off. This protection is two-stage control ensured by both LML system and travel switch.

### Back-stop Device

- Its major components are nesting tubes and spring, in order to buffer the boom backlash and prevent further tipping back.

### Boom Angle Indicator

- Pendulum angle indicator is fixed on the side of boom base close to the cab, so as to provide convenience to the operator.

### Hook Latch

- The lifting hook is installed with a baffle plate to prevent wire rope from falling off.

## Safety Device



### Lightning Protection Device

- It is offered as an optional feature, which includes the grounding device that can effectively protect the electric system elements and workers from lightning.

### Tri-color Load Indicator

- The load indication light has three colors, green, yellow and red, and the real time load status is presented on the display. When the actual load is smaller than 90% of rated load, the green light is on; when the actual load is larger than 90% and smaller than 100%, the yellow light is on, the alarm light flashes and sends out intermittent sirens; when the actual load reaches 100% of rated load, the red light on, the alarm light flashes and sends out continuous sirens. At this moment, the system will automatically cut off the crane's dangerous operation.

### Audio-Visual Alarm

- When the engine is working, the light flashes; when the machine is traveling or swinging, it sends out siren.

### Swing Indicator Light

- The swing indicator light flashes during traveling or swing.

### Illuminating Light

- The machine is equipped with, low-beam light in front of machine, front angle adjustable high-beam, lamps in operator's cab, lighting devices for night operation, so as to increase the visibility during work.

### Rearview Mirror

- It is installed on the left of the operator's cab and the front handrail on sheet metal for monitoring the rear part of the machine.

### Pharos

- Pharos is mounted on the top of boom/jib to indicating the height.

### Anemometer

- It is mounted on the top of boom/jib, and displayed on the monitor in the cab.

### Electronic Level Gauge

- It displays the tipping angle of crane on the monitor in real time, and automatically sends out alarm when it exceeds the set limit to warn the operator.

### Function Lock Lever

- Put down the function lock lever on the left side of cab seat or if the operator leaves the seat, all control levers will be de-activated to prevent any mis-operation due to accidental collision.

### Engine Power Limit Load Adjustment and Stalling Protection

- The controller monitors the engine power to prevent engine getting stuck and stalling.

### Engine Status Monitoring

- The engine status will be presented, such as engine coolant temperature, fuel volume, total work hours, engine oil pressure, engine speed, battery charging, voltage.





**SCC800A**  
**SANY CRAWLER CRANE**  
**80 TONS LIFTING CAPACITY**

QUALITY CHANGES THE WORLD

## Technical Parameters

- Page 10 Major Performance & Specifications
- Page 11 Outline Dimension
- Page 12 Transport Dimension
- Page 17 Transport Plan



## Major Performance & Specifications

Major Performance & Specifications of SCC800A			
Performance Indicators		Unit	Parameter
Boom Configuration	Max. rated lifting capacity	t	80
	Max. lifting moment	t·m	70×5=350
	Boom length	m	12~57
	Boom luffing angle	°	30~80
FJ	Max. rated lifting capacity	t	11
	Jib length	m	9~18
	Longest boom + longest jib	m	48+18
Speed	Rope speed of main/aux. winch (1st layer)	m/min	121
	Rope speed of boom hoist winch (3rd layer)	m/min	59
	Swing speed	rpm	2.7
	Travel speed	km/h	2.0/1.0
Wire rope	Main load hoist wire rope: diameter × length	φ mm × m	26×240
	Aux. load hoist wire rope: diameter × length	φ mm × m	26×180
	Single line pull of main/aux. load hoist wire rope	t	12
Engine	Model/Displacement		6HK1/7.79
	Rated power/Revolution speed	kW/ rpm	212/2000
Transport	Weight of basic boom	t	81
	Rear counterweight	t	27.6
	Carbody counterweight	t	2×2
	Transport weight of basic machine (with crawler frame and boom base)	t	46.2
	Transport weight of basic machine (without crawler frame)	t	27.8
	Machine transport dimension (with crawlers and boom base)L×W×H	mm	12800×3490×3450
	Machine transport dimension (without crawlers and boom base)L×W×H	mm	8310×3000×3050
Other specifications	Average ground pressure (basic boom)	MPa	0.081
	Gradeability	%	30

Unit: mm

## Outline Dimension

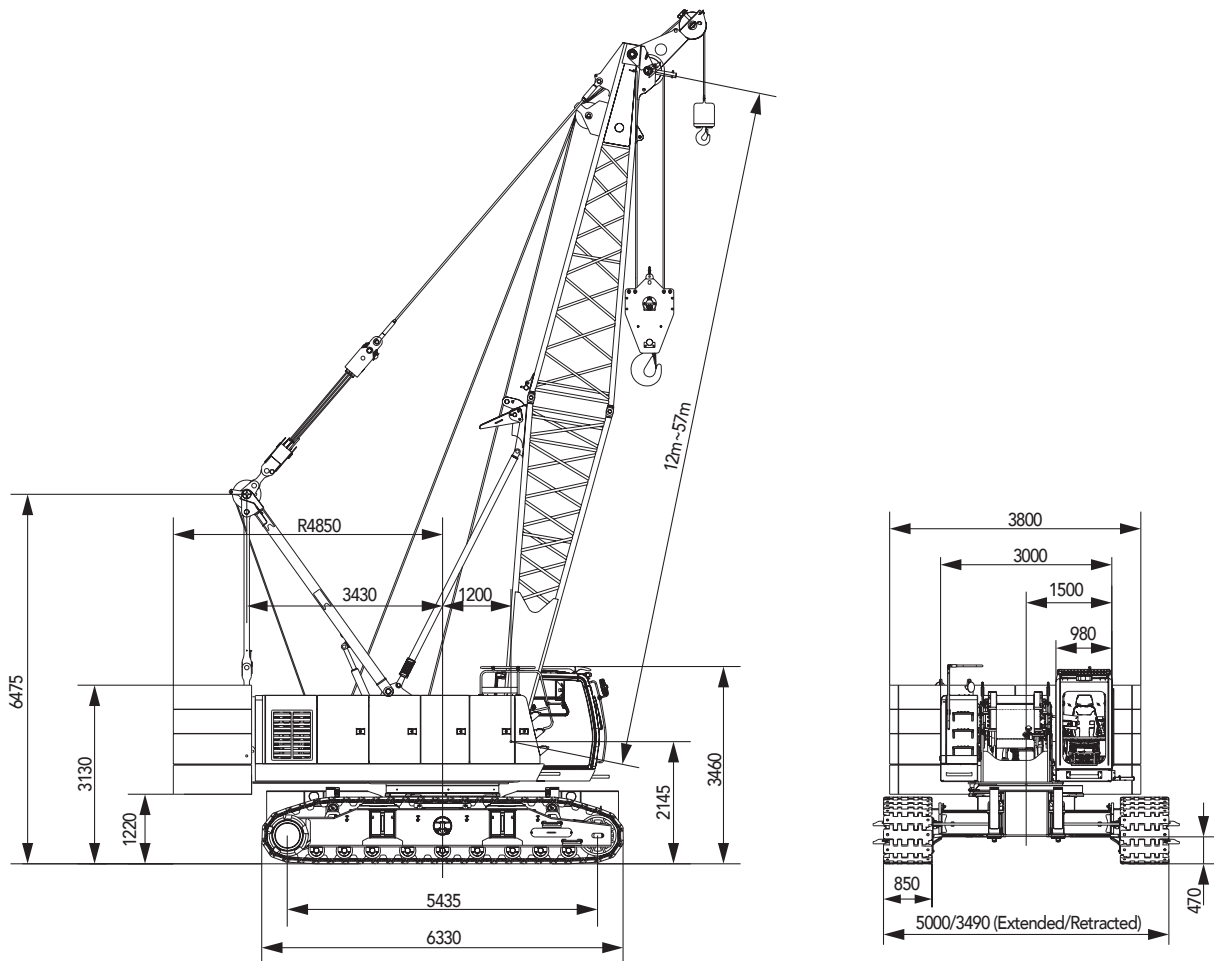

Note: Counterweight dimension in this scheme is standardized, not self-assembled. Third drum and assisting assembly cylinder for optional features are not shown in the figure.

## Transport Dimension

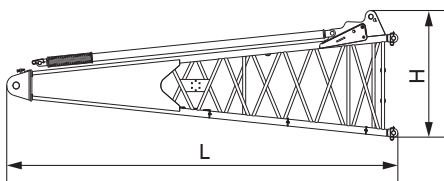
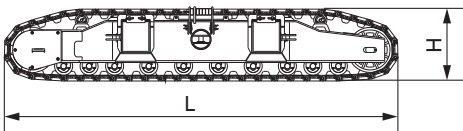
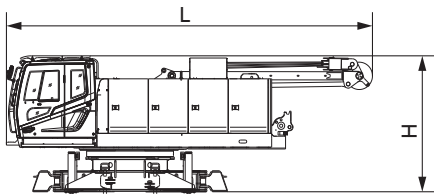
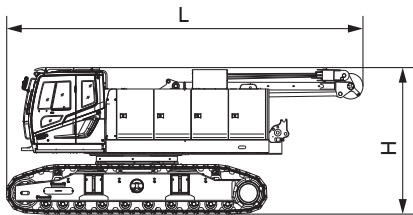
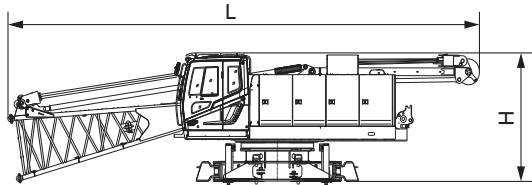
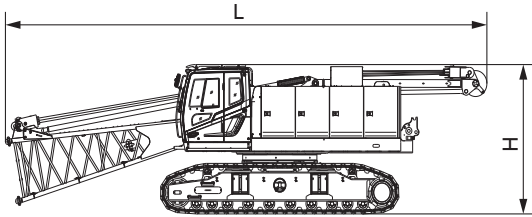

### Basic Machine 1 (with boom base, crawlers and outriggers) ×1

Length(L)	12.80m
Width(W)	3.49m
Height(H)	3.45m
Weight	46.2t

### Basic Machine 2 (with boom base) ×1

Length (L)	12.8m
Width (W)	3.00m
Height (H)	3.05m
Weight	27.8t

### Basic Machine 3 (with crawlers) ×1

Length (L)	8.65m
Width (W)	3.49m
Height (H)	3.46m
Weight	44.6t

### Basic Machine 4 ×1

Length(L)	8.31m
Width(W)	3.00m
Height(H)	3.05m
Weight	26.2t

### Crawlers ×1

Length(L)	6.33 m
Width(W)	1.09m
Height(H)	1.15m
Weight	9.2t

### Boom Base ×1

Length(L)	6.22 m
Width(W)	1.51m
Height(H)	1.87m
Weight	1.59t

## Transport Dimension

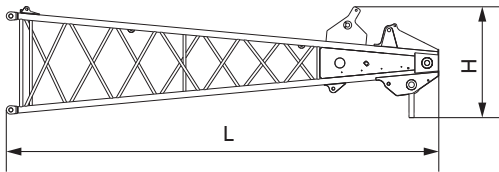

### Boom Top ×1

Length(L)	6.47 m
Width(W)	1.49m
Height(H)	1.66m
Weight	1.24t

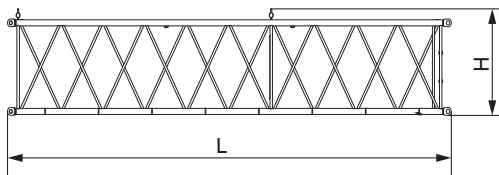

### 9m Boom Insert ×4

Length (L)	9.13 m
Width (W)	1.51m
Height (H)	1.56m
Weight	0.91t

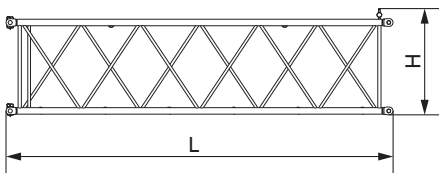

### 6m Boom Insert ×1

Length (L)	6.14 m
Width (W)	1.51m
Height (H)	1.56m
Weight	0.76t

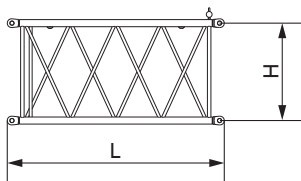

### 3m Boom Insert ×1

Length(L)	3.14 m
Width(W)	1.51m
Height(H)	1.56m
Weight	0.45t

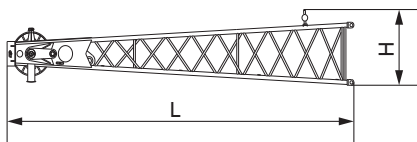

### Fixed Jib Top ×1

Length(L)	4.93m
Width(W)	0.87m
Height(H)	0.92m
Weight	0.31t

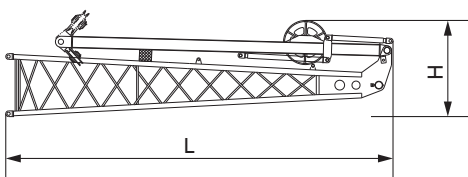

### Fixed Jib Base and Strut ×1

Length(L)	4.75 m
Width(W)	0.87m
Height(H)	1.18m
Weight	0.75t

## Transport Dimension

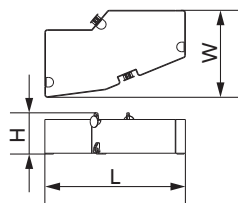
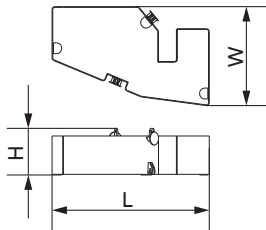
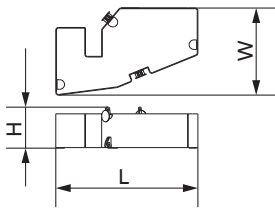
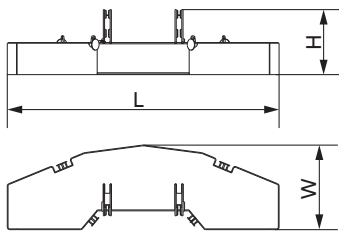
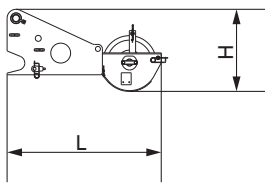
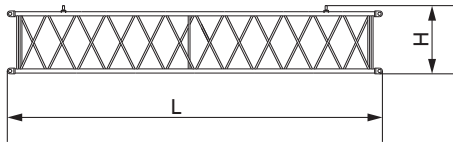

### 4.5m Fixed Jib

×2

Length(L)	4.57m
Width(W)	0.87m
Height(H)	0.83m
Weight	0.24t

### Extension Jib

×1

Length (L)	1.55m
Width (W)	0.96m
Height (H)	0.82m
Weight	0.30t

### Counterweight Tray

×1

Length (L)	3.80m
Width (W)	1.55m
Height (H)	1.05m
Weight	8.26t

### Left Counterweight Block I

×1

Length(L)	1.89m
Width(W)	1.55m
Height(H)	0.65m
Weight	3.68t

### Right Counterweight Block I

×1

Length(L)	1.89m
Width(W)	1.55m
Height(H)	0.65m
Weight	3.68t

### Left Counterweight Block II

×2

Length(L)	1.89m
Width(W)	1.55m
Height(H)	0.54m
Weight	3t

## Transport Dimension

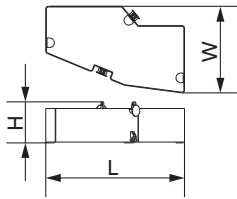

### Right Counterweight Block II

×2

Length(L)	1.89m
Width(W)	1.55m
Height(H)	0.54m
Weight	3.0t

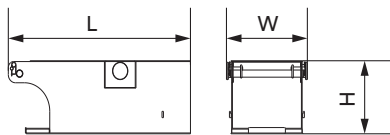

### Carbody Counterweight

×2

Length (L)	2.02 m
Width (W)	0.90m
Height (H)	0.72m
Weight	2.0t

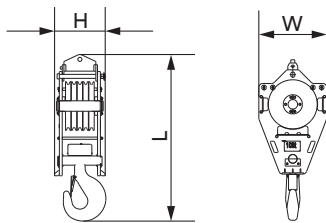

### 100T hook

×1

Length (L)	2.08m
Width (W)	0.85m
Height (H)	0.63m
Weight	1.36t

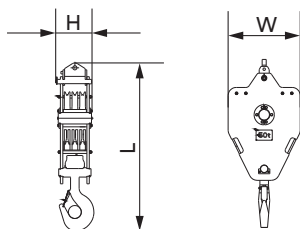

### 50T hook

×1

Length(L)	1.95 m
Width(W)	0.90m
Height(H)	0.45m
Weight	1.04t

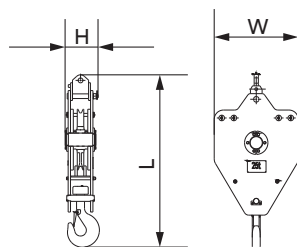

### 25T hook

×1

Length(L)	1.86 m
Width(W)	0.90m
Height(H)	0.35m
Weight	0.79t

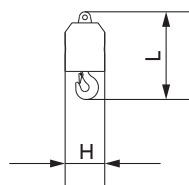

### 13.5T Ball Hook

×1

Length(L)	0.95m
Width(W)	0.43m
Height(H)	0.43m
Weight	0.47t

## Transport Dimension

The followings are for optional self-assembled counterweight

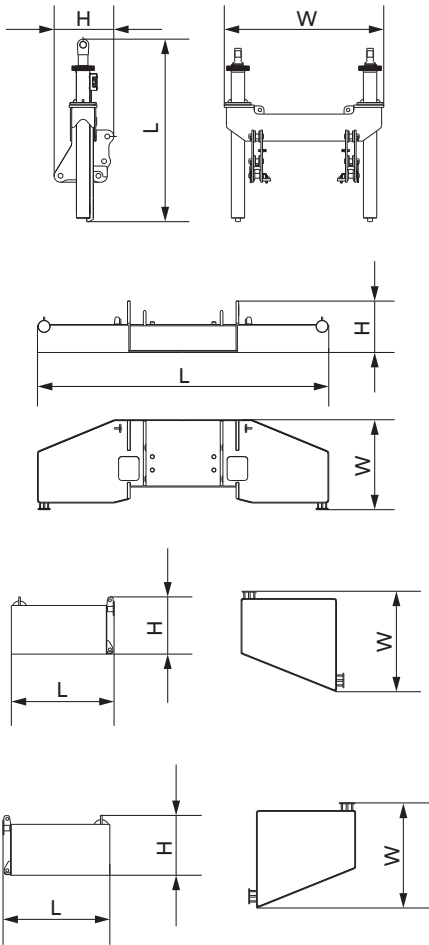

### Counterweight cylinder bracket ×1

Length(L)	2.28 m
Width(W)	1.98m
Height(H)	0.74m
Weight	1.4t

Note: weight includes that for chains and pendant bar

### Counterweight tray ×1

Length (L)	4.40 m
Width (W)	1.35m
Height (H)	0.77m
Weight	5.5t

### Left Counterweight Block ×3

Length (L)	1.33 m
Width (W)	1.26m
Height (H)	0.72m
Weight	3.45t

### Right Counterweight Block ×3

Length(L)	1.33 m
Width(W)	1.26m
Height(H)	0.72m
Weight	3.45t

Note:

- 1.The transport dimensions of each part in the table are schematic, not proportional to the real parts. The dimensions are designed value without package considered.
- 2.The Weight is designed value that the actual manufactured part may deviate a little.



## Transport Plan

Plan A: Transport without crawlers. Width: 3m.

Trailer 1	
Part(s)	<ul style="list-style-type: none"> <li>Basic Machine</li> <li>Carbody Counterweight x1</li> </ul>
Weight	<ul style="list-style-type: none"> <li>30t</li> </ul>

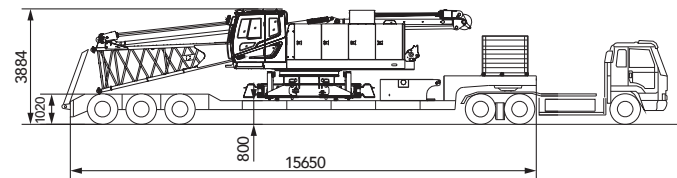

Trailer 2	
Part(s)	<ul style="list-style-type: none"> <li>Crawler assembly (left and right)</li> <li>9m boom x2</li> <li>Boom top x1</li> <li>6m boom x1</li> <li>4.5m fixed jib x2</li> <li>Extension jib x1</li> <li>Carbody counterweight x 1</li> <li>Right counterweight 2x1</li> <li>100t hook x1</li> <li>25t hook x1</li> </ul>
Weight	<ul style="list-style-type: none"> <li>30.2t</li> </ul>

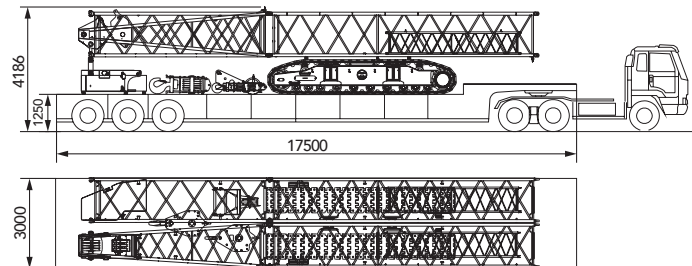

Trailer 3	
Part(s)	<ul style="list-style-type: none"> <li>9m boom x2</li> <li>3m boom x1</li> <li>Fixed jib base x1</li> <li>Fixed jib top x1</li> <li>Counterweight tray x1</li> <li>Left counterweight 1x1</li> <li>Right counterweight 1x1</li> <li>Left counterweight 2x2</li> <li>Right counterweight 2x1</li> <li>50t hook x 1</li> <li>13.5t hook x 1</li> </ul>
Weight	<ul style="list-style-type: none"> <li>29.5t</li> </ul>

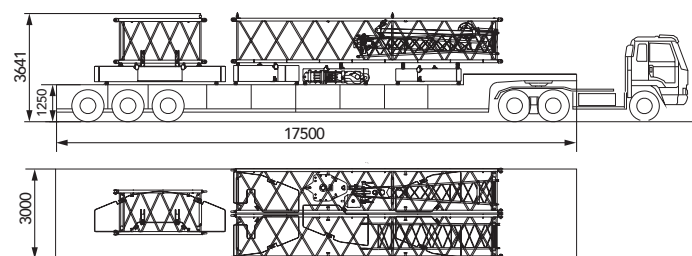

## Transport Plan

### Plan B: Transport with crawlers.

Trailer 1	
Part(s)	▪ Basic Machine
Weight	▪ 46.2t

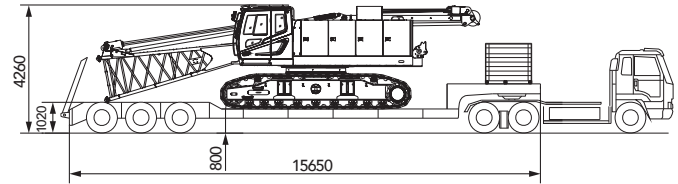

Trailer 2	
Part(s)	<ul style="list-style-type: none"> <li>▪ 9m boom x2</li> <li>▪ Boom top x1</li> <li>▪ 6m boom x1</li> <li>▪ Extension jib x1</li> <li>▪ Carbody counterweight x 2</li> <li>▪ 4.5m fixed jib x2</li> <li>▪ Left counterweight 2x1</li> <li>▪ Right counterweight 2x1</li> <li>▪ 100t hook x1</li> <li>▪ 50t hook x1</li> <li>▪ 25t hook x1</li> <li>▪ 13.5t hook x 1</li> </ul>
Weight	▪ 18.3t

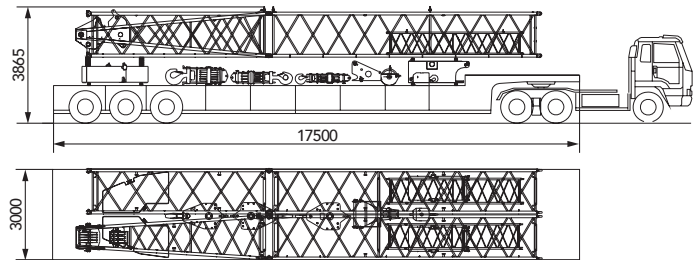

Trailer 3	
Part(s)	<ul style="list-style-type: none"> <li>▪ 9m boom x2</li> <li>▪ 3m boom x1</li> <li>▪ Left counterweight 1x1</li> <li>▪ Right counterweight 1x1</li> <li>▪ Counterweight tray x1</li> <li>▪ Left counterweight 2x1</li> <li>▪ Right counterweight 2x1</li> <li>▪ Fixed jib top x 1</li> <li>▪ Fixed jib base x 1</li> </ul>
Weight	▪ 25t

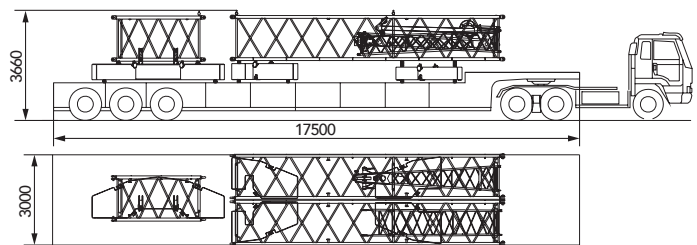



**SCC800A**  
**SANY CRAWLER CRANE**  
**80 TONS LIFTING CAPACITY**

QUALITY CHANGES THE WORLD

## Cofigurations

- Page 21 H Configuration
- Page 26 FJ Configuration

> 19

### Boom Combination

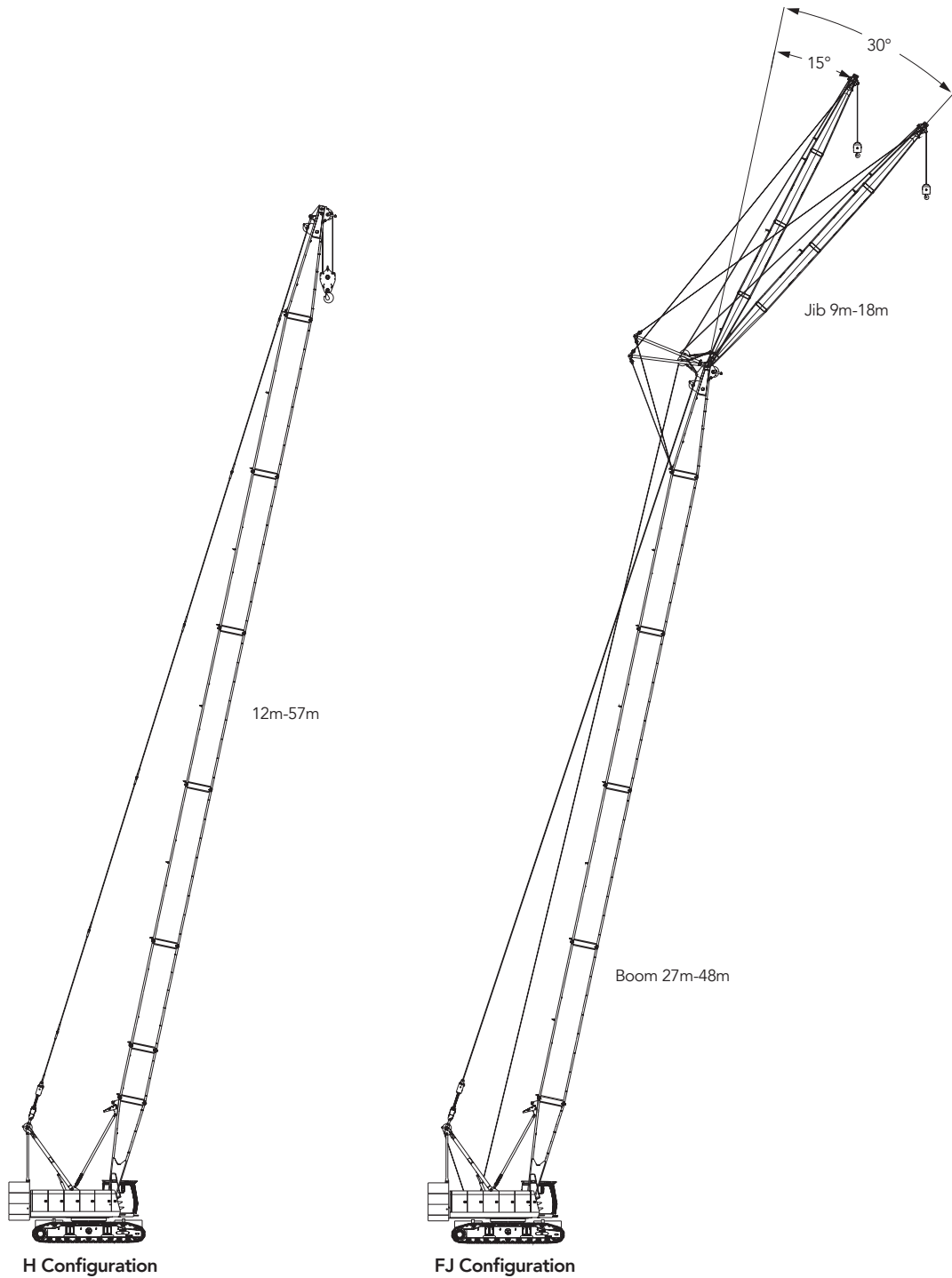

## H Configuration

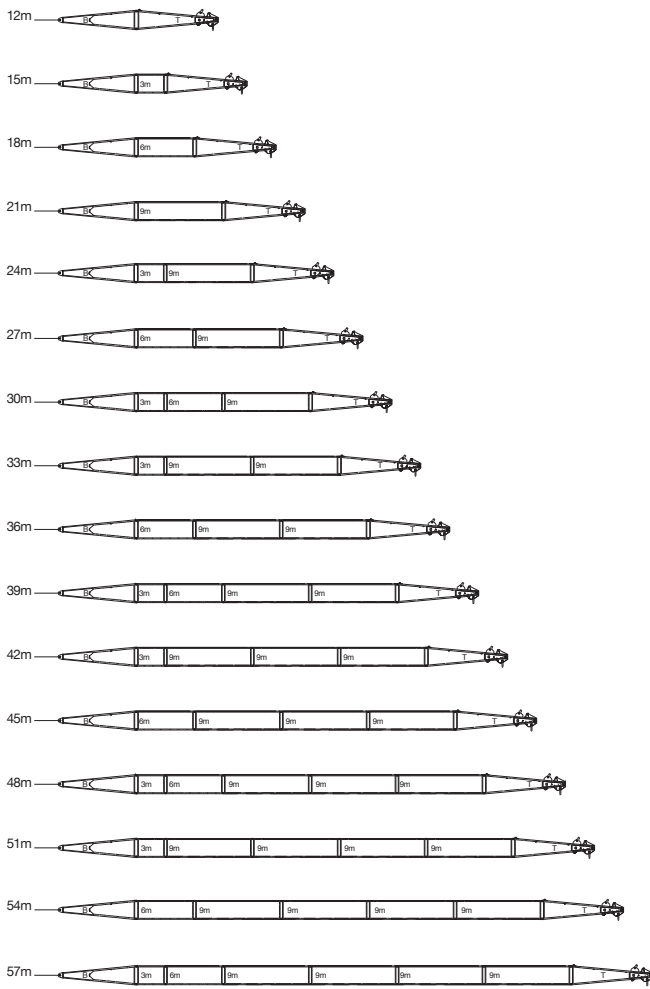

	6m	Boom base
	6m	Boom top
	3m	Insert Boom
	6m	Insert Boom
	9m	Insert Boom

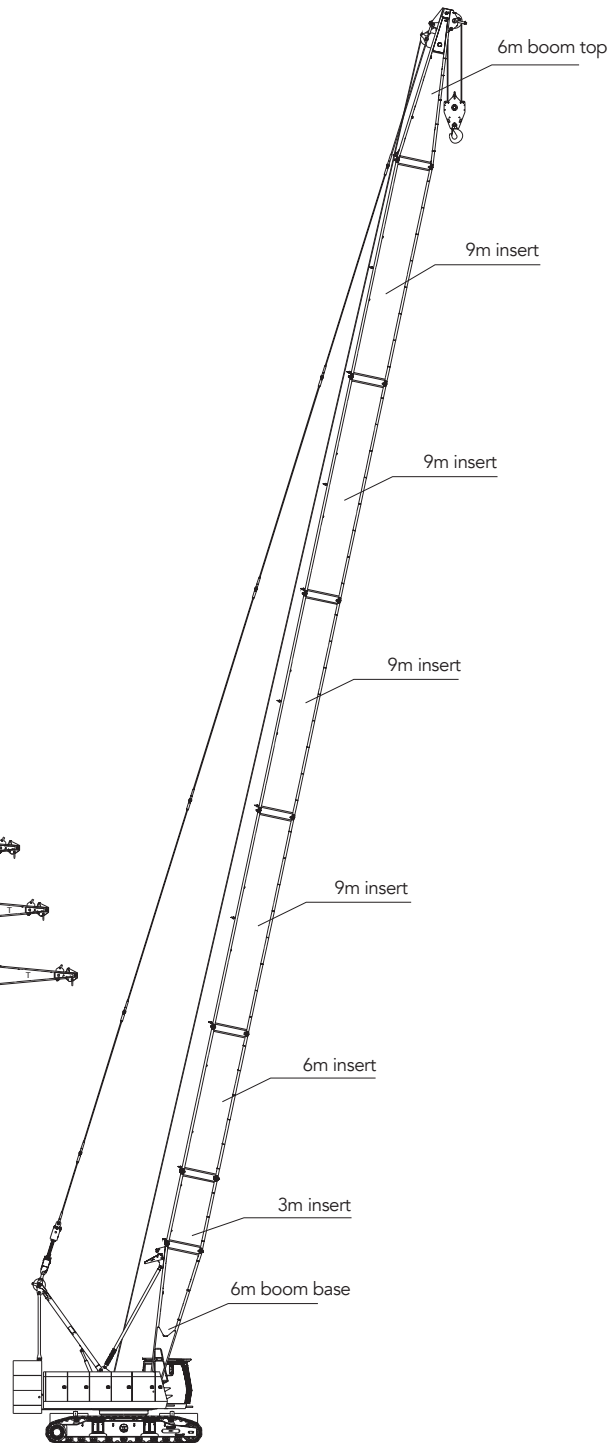

## Working Radius in H Configuration

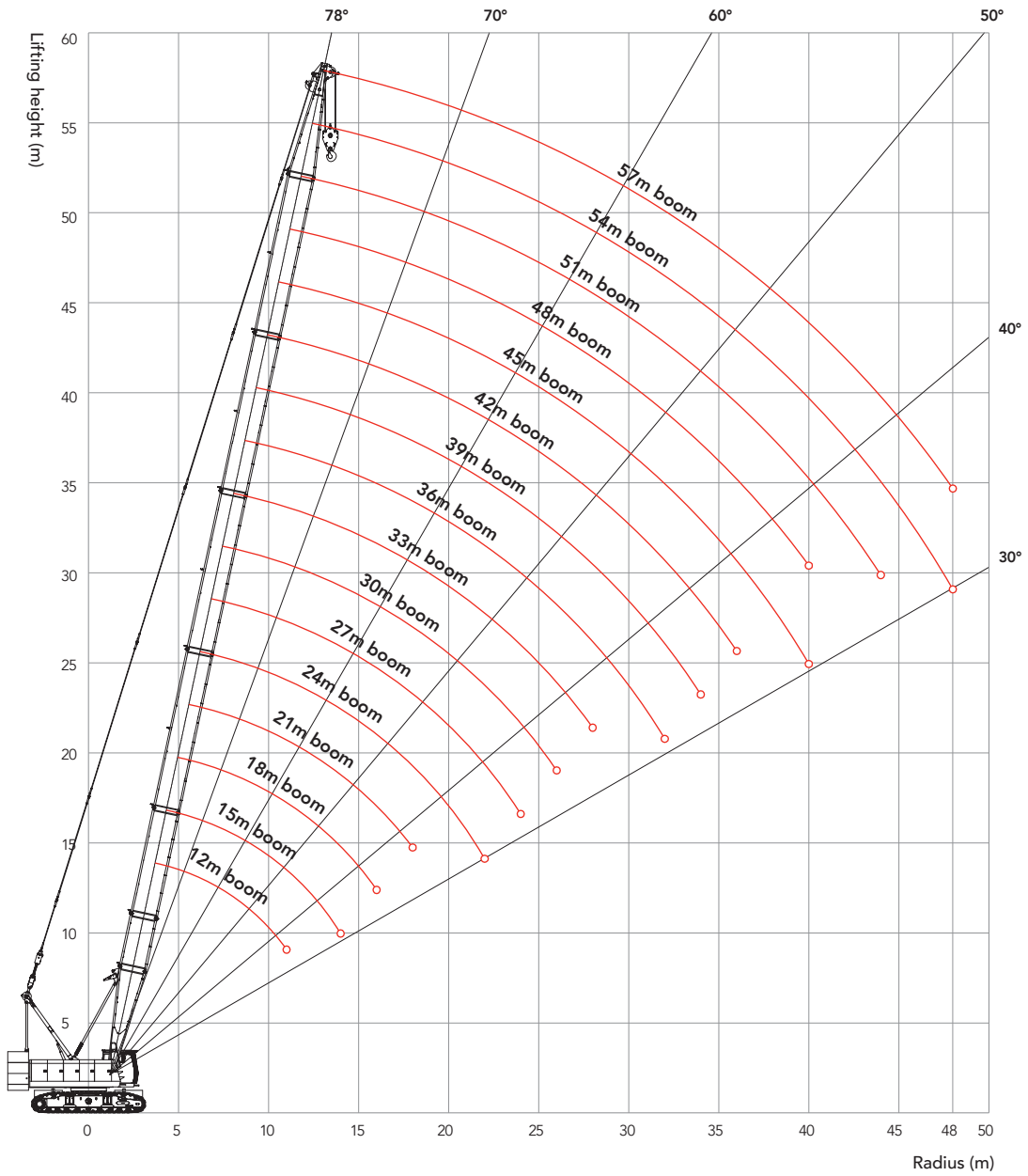

Unit: t

## Load Chart of H Configuration

Note:

- 1.The rated load in the load chart is calculated complying with EN 13000;
- 2.The working radius is the horizontal distance from the load center to the swing center;
- 3.The actual lifting capacity must subtract the weight of hooks and other riggings from the rated capacity in the load chart.
- 4.The load value is calculated when the object is hung freely,without considering the influence of wind on the load, ground conditions and slope, operation speed and the influence of any other negative factors over safe operation. Therefore, the operator bears the responsibility of making a judgment and decreasing the load and lowering speed.
- 5.All ratings are calculated when the machine is parking on firm and level ground with less than 1% gradient.

SCC800A Crawler Crane –H Configuration 1/2									
R/BL (m)	Rear Counterweight 27.6t					Carbody Counterweight 4t			R/BL (m)
	12	15	18	21	24	27	30	33	
4.3	80								4.3
5	70	68							5
6	55.3	54.7	54.2	52.5					6
7	43.8	43.4	43.1	42.7	42.1				7
8	36.3	35.9	35.7	35.4	35.1	34.8	34.1		8
9	30.9	30.6	30.4	30.1	29.9	29.6	29.4	29.1	9
10	26.8	26.6	26.4	26.2	25.9	25.7	25.6	25.3	10
11	23.7	23.5	23.3	23.1	22.9	22.7	22.5	22.3	11
12		21	20.8	20.7	20.4	20.3	20.1	19.9	12
14		17.3	17.1	17	16.8	16.6	16.5	16.3	14
16			14.5	14.3	14.1	14	13.9	13.7	16
18				12.4	12.2	12	11.9	11.7	18
20					10.6	10.5	10.4	10.2	20
22					9.4	9.3	9.2	9	22
24						8.3	8.2	8	24
26							7.3	7.2	26
28								6.4	28

Note: the values shaded in dark gray are determined by boom strength, and others are determined by stability

## Load Chart of H Configuration

SCC800A Crawler Crane –H Configuration 2/2									
R/BL (m)	Rear Counterweight 27.6t				Carbody Counterweight 4t				R/BL (m)
	36	39	42	45	48	51	54	57	
9	28.4								9
10	25.1	24.7							10
11	22.1	22	21.6	21.1					11
12	19.8	19.6	19.4	19.2	18.8	18.3			12
14	16.1	16	15.8	15.7	15.6	15.3	15	14.6	14
16	13.6	13.5	13.3	13.1	13	12.8	12.6	12.4	16
18	11.6	11.5	11.3	11.2	11.1	10.9	10.7	10.6	18
20	10.1	10	9.8	9.7	9.6	9.4	9.2	9.1	20
22	8.9	8.8	8.6	8.5	8.4	8.2	8	7.9	22
24	7.9	7.8	7.6	7.5	7.3	7.2	7.1	6.9	24
26	7	6.9	6.8	6.6	6.5	6.4	6.2	6.1	26
28	6.3	6.2	6.1	5.9	5.8	5.7	5.5	5.4	28
30	5.7	5.6	5.5	5.3	5.2	5.1	4.9	4.8	30
32	5.2	5.1	4.9	4.8	4.7	4.5	4.4	4.3	32
34		4.7	4.5	4.4	4.3	4.1	4	3.8	34
36			4.1	3.9	3.8	3.7	3.6	3.4	36
38				3.6	3.5	3.3	3.2	3	38
40				3.3	3.2	3	2.9	2.7	40
44						2.4	2.3	2.2	44
48							1.8	1.6	48

Note: the values shaded in dark gray are determined by boom strength, and others are determined by stability



Unit: t

## Load Chart of H Configuration

SCC800A Crawler Crane –H Configuration																
Rear counterweight about 21.2t, remove one block on left and right each, no carbody counterweight																
R/BL (m)	12	15	18	21	24	27	30	33	36	39	42	45	48	51	54	R/BL (m)
4.3	80															4.3
5	60.1	59.5														5
6	44.6	44.2	43.8	43.4												6
7	35.3	35	34.7	34.5	34.2	33.9										7
8	29.2	28.9	28.7	28.5	28.3	28.1	27.9									8
9	24.8	24.6	24.4	24.3	24	23.9	23.7	23.5	23.3							9
10	21.6	21.3	21.2	21.1	20.9	20.7	20.6	20.4	20.2	20.1	19.9					10
11	19	18.8	18.7	18.6	18.4	18.2	18.1	17.9	17.8	17.7	17.5	17.3				11
12		16.8	16.7	16.6	16.4	16.2	16.1	16	15.8	15.7	15.5	15.4	15.3	15.1		12
14		13.8	13.7	13.6	13.4	13.3	13.2	13	12.9	12.8	12.6	12.5	12.4	12.2	12.1	14
16			11.5	11.4	11.3	11.1	11	10.9	10.8	10.7	10.5	10.4	10.3	10.1	10	16
18				9.8	9.7	9.5	9.4	9.3	9.2	9.1	8.9	8.8	8.7	8.6	8.4	18
20					8.4	8.3	8.2	8	7.9	7.9	7.7	7.6	7.5	7.3	7.2	20
22					7.4	7.3	7.2	7.1	7	6.9	6.7	6.6	6.5	6.4	6.2	22
24						6.5	6.4	6.2	6.1	6	5.9	5.8	5.7	5.5	5.4	24
26							5.7	5.6	5.5	5.4	5.2	5.1	5	4.9	4.7	26
28								5	4.9	4.8	4.6	4.5	4.5	4.3	4.2	28
30									4.4	4.3	4.1	4	3.9	3.8	3.7	30
32									4	3.9	3.7	3.6	3.5	3.4	3.2	32
34										3.5	3.3	3.2	3.1	3	2.9	34
36											3	2.9	2.8	2.7	2.5	36
38												2.6	2.5	2.4	2.2	38
40												2.3	2.2	2.1	2	40
44														1.6	1.5	44
48															1.1	48

## FJ Configuration

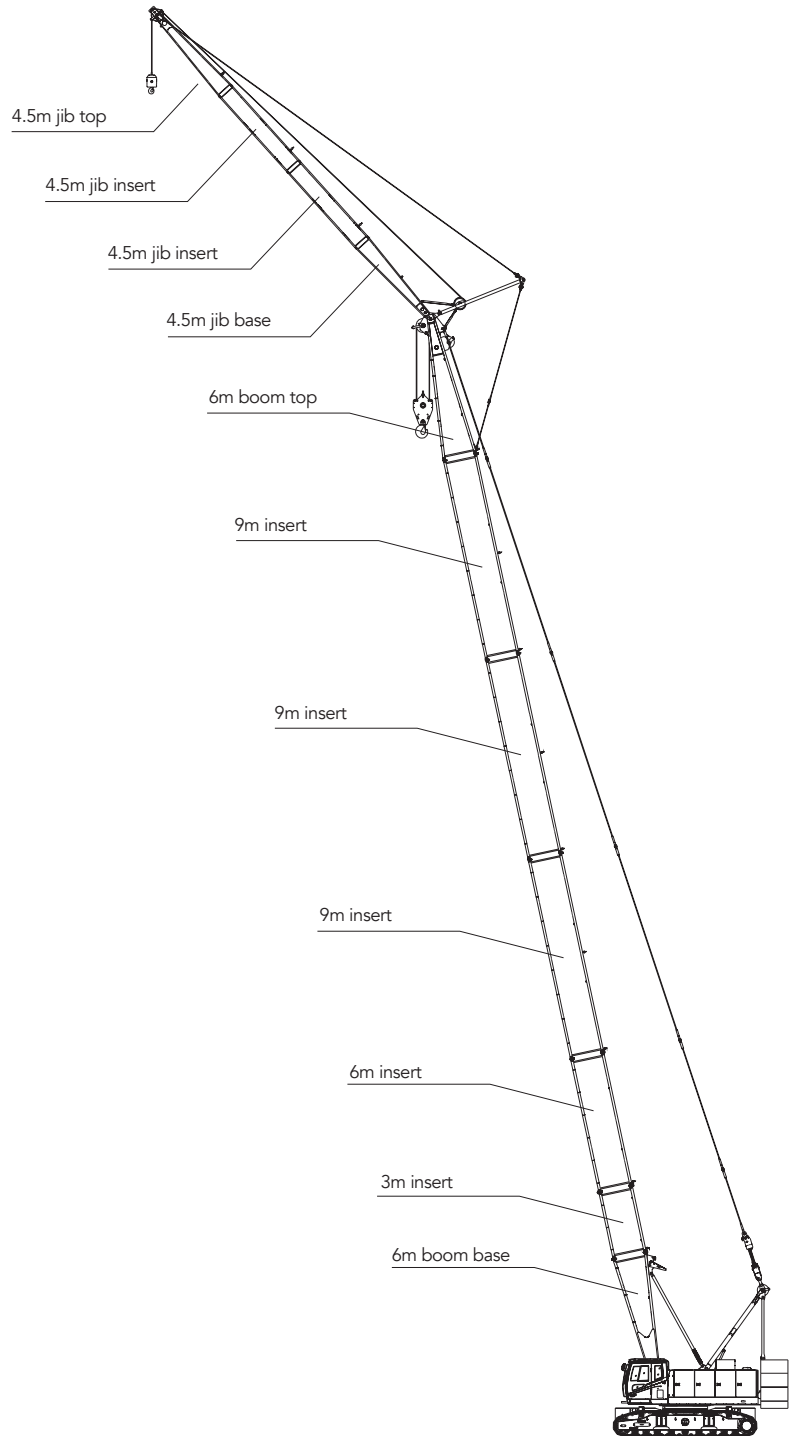
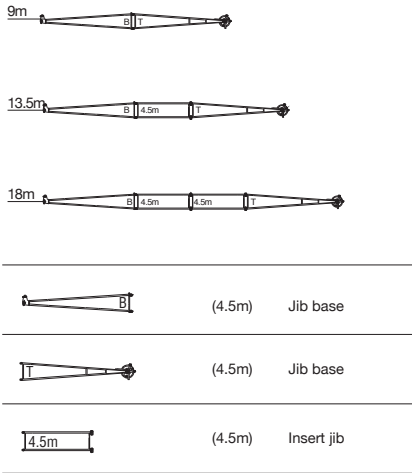

## Working Radius in FJ Configuration

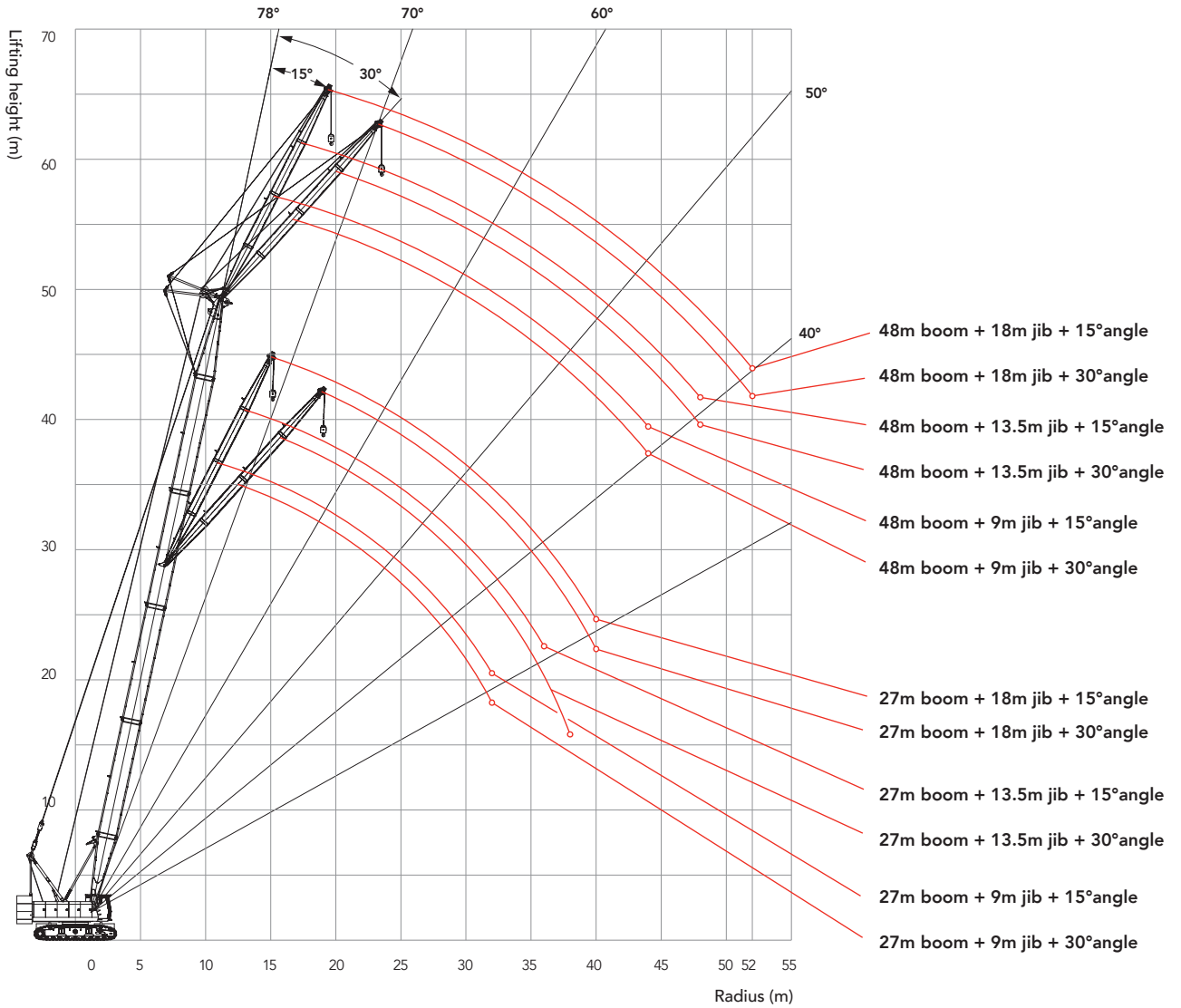

### Load Chart of FJ Configuration

Note:

- 1.The rated load in the load chart is calculated complying with EN 13000;
- 2.The working radius is the horizontal distance from the load center to the swing center;
- 3.The actual lifting capacity must subtract the weight of hooks and other riggings from the rated capacity in the load chart.
- 4.The load value is calculated when the object is hung freely,without considering the influence of wind on the load, ground conditions and slope, operation speed and the influence of any other negative factors over safe operation. Therefore, the operator bears the responsibility of making a judgment and decreasing the load and lowering speed.
- 5.All ratings are calculated when the machine is parking on firm and level ground with less than 1% gradient.

SCC800A Crawler Crane – FJ 1/4													
Rear Counterweight 27.6t; Carbody Counterweight 4t													
R/BL (m) Jib Length (m) Boom to Jib Angle	9		27 13.5		18		9		30 13.5		18		R/BL (m) Jib Length (m) Boom to Jib Angle
	15°	30°	15°	30°	15°	30°	15°	30°	15°	30°	15°	30°	
12	11						11						12
14	11	11	11				11	11	11				14
16	11	11	11			10.6		11	11	11		10.2	16
18	11	11	10.8	8.9	9.7		11	11	10.5	9	9.4		18
20	10	10.1	9.7	8.4	8.6	7.3	9.8	10	9.4	8.6	8.4	7.3	20
22	8.8	8.9	8.8	8.1	7.8	6.9	8.6	8.8	8.5	8.2	7.6	6.9	22
24	7.8	7.9	7.9	7.7	7.1	6.6	7.6	7.7	7.8	7.6	6.9	6.6	24
26	7	7.1	7.1	7.2	6.5	6.3	6.8	6.9	6.9	7	6.3	6.2	26
28	6.3	6.3	6.4	6.5	6	6	6.1	6.2	6.2	6.4	5.8	5.8	28
30	5.7	5.7	5.8	5.9	5.5	5.6	5.5	5.6	5.6	5.8	5.3	5.3	30
32	5.2	5.2	5.3	5.3	5.1	5.1	5	5	5.1	5.2	4.9	4.9	32
34			4.8	4.9	4.6	4.8	4.5	4.6	4.6	4.7	4.5	4.6	34
36			4.4	4.4	4.2	4.4		4.1	4.2	4.3	4.2	4.2	36
38				4	3.9	4			3.8	3.9	3.8	4	38
40					3.5	3.7			3.5	3.5	3.5	3.7	40
44											2.8	3	44

Note: the values shaded in dark gray are determined by boom strength, and others are determined by stability

Unit: t

## Load Chart of FJ Configuration

SCC800A Crawler Crane – FJ 2/4													
Rear Counterweight 27.6t; Carbody Counterweight 4t													
R/BL (m) Jib Length (m) Boom to Jib Angle	9		33 13.5		18		9		36 13.5		18		R/BL (m) Jib Length (m) Boom to Jib Angle
	15°	30°	15°	30°	15°	30°	15°	30°	15°	30°	15°	30°	
14	11								11				14
16	11	11	11						11	11	11		16
18	11	11	10.2	9.1	9				11	11	10	8.8	18
20	9.7	9.9	9.2	8.5	8.2				9.6	9.8	9	8.3	20
22	8.5	8.7	8.3	8	7.4	6.7			8.4	8.6	8.2	7.8	22
24	7.5	7.7	7.6	7.4	6.7	6.3			7.4	7.6	7.5	7.1	24
26	6.7	6.8	6.8	6.8	6.2	6			6.6	6.7	6.7	6.6	26
28	6	6.1	6.1	6.3	5.7	5.6			5.9	6	6	6.2	28
30	5.4	5.5	5.5	5.7	5.2	5.2			5.3	5.4	5.4	5.6	30
32	4.9	4.9	5	5.1	4.8	4.8			4.8	4.8	4.9	5	32
34	4.4	4.5	4.5	4.7	4.4	4.5			4.3	4.4	4.4	4.6	34
36	4	4	4.1	4.2	4.1	4.2			3.9	3.9	4	4.1	36
38	3.6	3.6	3.7	3.8	3.8	3.8			3.5	3.5	3.6	3.7	38
40			3.4	3.5	3.4	3.6			3.2	3.2	3.3	3.4	40
44					2.9	3					2.7	2.7	44
48												2.3	48

Note: the values shaded in dark gray are determined by boom strength, and others are determined by stability

### Load Chart of FJ Configuration

SCC800A Crawler Crane – FJ 3/4													
Rear Counterweight 27.6t; Carbody Counterweight 4t													
R/BL (m) Jib Length (m) Boom to Jib Angle	39						42						R/BL (m) Jib Length (m) Boom to Jib Angle
	9		13.5		18		9		13.5		18		
	15°	30°	15°	30°	15°	30°	15°	30°	15°	30°	15°	30°	
14	11												14
16	11	11	11				11						16
18	10.9	10.8	9.8		8.6		10.8	10.5	9.7				18
20	9.4	9.6	8.8	8	7.8		9.3	9.5	8.6	7.8	7.7		20
22	8.2	8.4	8	7.6	7.1	6.2	8.1	8.3	7.8	7.4	7		22
24	7.2	7.4	7.3	7	6.4	5.9	7.1	7.3	7.2	6.8	6.3	5.7	24
26	6.4	6.6	6.6	6.4	5.9	5.6	6.3	6.5	6.5	6.3	5.7	5.4	26
28	5.7	5.9	5.9	5.9	5.4	5.2	5.6	5.8	5.8	5.8	5.3	5.1	28
30	5.1	5.2	5.3	5.5	5	4.8	5	5.1	5.1	5.4	4.9	4.7	30
32	4.6	4.7	4.7	4.9	4.6	4.5	4.4	4.6	4.6	4.8	4.5	4.3	32
34	4.1	4.2	4.2	4.4	4.2	4.2	4	4.1	4.1	4.3	4.2	4.1	34
36	3.7	3.8	3.8	4	3.9	3.9	3.6	3.6	3.7	3.9	3.8	3.8	36
38	3.3	3.4	3.4	3.6	3.6	3.6	3.2	3.3	3.3	3.5	3.5	3.5	38
40	3	3	3.1	3.2	3.2	3.3	2.8	2.9	3	3.1	3.1	3.3	40
44			2.5	2.6	2.6	2.8	2.3	2.3	2.4	2.5	2.5	2.7	44
48			2	2.1	2.2	2.2			1.9	2	2	2.1	48
52					1.7	1.8					1.6	1.7	52

Note: the values shaded in dark gray are determined by boom strength, and others are determined by stability

Unit: t

## Load Chart of FJ Configuration

SCC800A Crawler Crane – FJ 4/4															
Rear Counterweight 27.6t; Carbody Counterweight 4t															
R/BL (m) Jib Length (m) Boom to Jib Angle	9		45 13.5		18		9		48 13.5		18		R/BL (m) Jib Length (m) Boom to Jib Angle		
	15°	30°	15°	30°	15°	30°	15°	30°	15°	30°	15°	30°			
16	11								11					16	
18	10.6	10.2	9.5						10.3	9.8	9.3			18	
20	9.1	9.2	8.4	7.6	7.5				8.8	8.8	8.2		7.3	20	
22	7.8	8	7.6	7.2	6.8				7.6	7.8	7.4	7	6.6	22	
24	6.9	7	7	6.6	6.1	5.5			6.7	6.8	6.8	6.4	5.9	5.3	24
26	6.1	6.2	6.3	6.1	5.5	5.2			5.8	5.9	6.1	5.9	5.3	5	26
28	5.3	5.5	5.6	5.6	5.1	4.9			5	5.2	5.4	5.4	4.9	4.7	28
30	4.8	4.8	4.9	5.2	4.7	4.5			4.5	4.5	4.7	5	4.5	4.3	30
32	4.2	4.3	4.4	4.6	4.3	4.1			4	4.1	4.2	4.4	4.1	3.9	32
34	3.8	3.8	3.9	4.1	4	3.9			3.6	3.6	3.7	3.9	3.8	3.7	34
36	3.3	3.3	3.5	3.7	3.6	3.6			3.1	3.1	3.3	3.5	3.4	3.4	36
38	3	3.1	3.1	3.3	3.3	3.3			2.8	2.8	2.9	3.1	3.1	3.1	38
40	2.5	2.7	2.8	2.9	2.9	3.1			2.2	2.5	2.6	2.7	2.7	2.9	40
44	2	2.1	2.2	2.3	2.3	2.5			1.7	1.8	2	2.1	2.1	2.3	44
48			1.7	1.8	1.8	1.9					1.5	1.6	1.6	1.7	48
52					1.4	1.5							1.2	1.3	52

Note: the values shaded in dark gray are determined by boom strength, and others are determined by stability



## Zhejiang SANY Equipment Co., Ltd.

SANY Industrial Park, No. 2087 Daishan Road, Wuxing District, Huzhou City,  
Zhejiang Province, P. R. of China Zip 313028  
After-sales Service 400 887 8318  
Consulting 400 887 9318

— Agent information —

Due to updated technology, the technical parameters and configurations are subject to change without prior notice. The machine in the picture may include additional equipment. This album is for reference only, subject to the object.  
All rights reserved for Sany, without the written permission of Sany, the contents of any part of this content shall not be copied or copied for any purpose.

© Printed in November 2018 in China

[www.sany.com.cn](http://www.sany.com.cn)



Please scan the official WeChat account of Sany for more information.