

# STC250H

STC250H TRUCK CRANE  
25 TONS LIFTING CAPACITY

Quality Changes the World

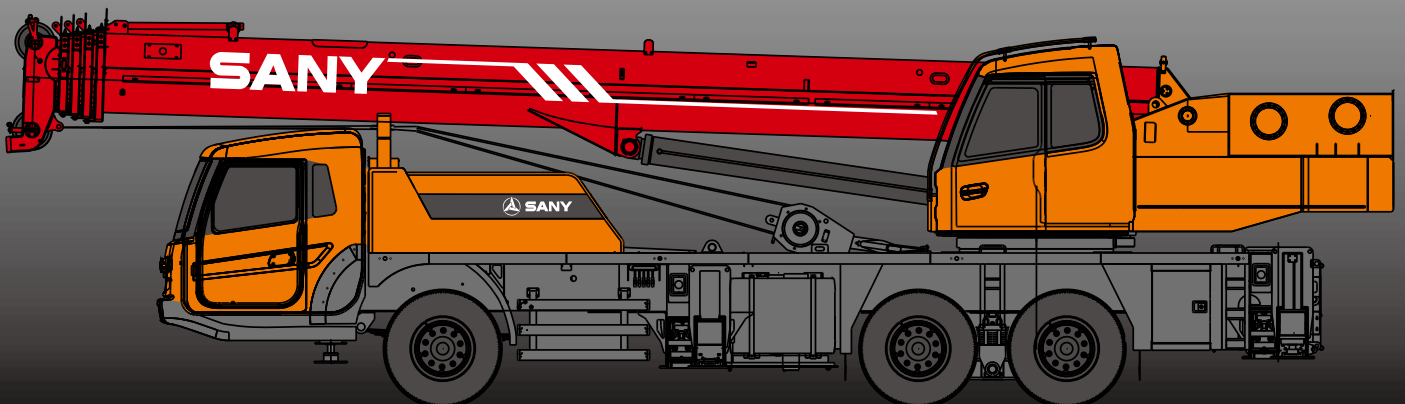

# SANY

■ SANY Automobile Hoisting Machinery is one of the core business unit of Sany Heavy Industry, mainly engaged in the research and development of high end, mid to large tonnage crane series, including mobile crane, crawler crane, tower crane and loader crane. It has two industrial parks in Ningxiang and Huzhou, since entering the market, the products of Sany Automobile Hoisting Machinery have received worldwide recognition with advanced technology, lean manufacturing, high reliability and excellent service.



# SANY TRUCK CRANE

## CONTENT

- 04 Icon
- 05 Selling Points
- 06 Introduction
- 09 Dimension
- 10 Technical Parameter
- 11 Operation Condition
- 12 Load Chart
- 14 Wheel Crane Family Map



### Excellent and stable chassis performance / chassis system

Double-axle drive is used, providing good trafficability and comfortableness under complex road condition with reliable traveling performance. Engine has the multimode power output function, which reduces power consumption.



### Ultra long and super strong boom system

Five-section boom of high strength steel structure and optimized U-shaped cross section reduces weight significantly with higher safety rates. Jib mounting angles are 0°, 15° and 30°, which ensures fast and convenient change-over between different operating conditions so as to improving working efficiency of the machine.



### Highly efficient, stable, energy-saving and adjustable hydraulic system

Load sensitive variable plunger pump is applied to provide real time adjustment of pump displacement, high-accuracy flow control, strong lifting capacity and good micro-mobility. Unique steering system is applied to ensure stable braking operation.





### Safe, stable, advanced and intelligent electric control system

Self-developed controller SYMC specially for engineering machinery is configured. The adoption of CAN-bus full-digital network control technology ensures stable control signal, simple harness and high reliability. Timely feedback of data information can achieve the monitoring of the overall working status in real-time. The load moment limiter equipped with the comprehensive intelligent protection system is used with accuracy within 3% to provide a comprehensive logic and interlock control, thus ensuring more safe and reliable operation.

## Superstructure

-  **Cab**
- It is made of safety glass and anti-corrosion steel plate with ergonomic design such as full-coverage soften interior, panoramic sunroof and adjustable seats etc., and humanized design providing more comfortable and relaxing operation experience. The display of load moment limiter integrates main console and operation display system, which clearly show the data of all operating superstructure conditions for lifting operation.

-  **Hydraulic system**
- High-quality key hydraulic components such as main oil pump, rotary pump, main valve, winch motor and balancing parts etc. are adopted to achieve stable and reliable operation of the hydraulic system. Superior operation performance is guaranteed by accurate parameter matching.
  - Main valve has flow compensation and load feedback control function, enabling stable and convenient control of single action and combined action under different operation conditions.
  - Winch adopts the variable motor to ensure high operation efficiency. Max. single line speeds of main and auxiliary winches is up to 120m/min, which ensures the lifting efficiency take the lead in industry.
  - The use of new hydraulic control variable slewing system ensures more stable starting and control of the slewing operation and excellent micro-mobility.

-  **Control system**
- CAN-bus instrument: CAN-bus instrument with a combined intelligent control electrical system is used for easy reading of the traveling parameters at any time. The engine fault warning function is applied to ensure convenient and fast troubleshooting.
  - Load moment limiter: The adoption of high intelligent load moment limiter system can
  - comprehensively protect lifting operation, ensuring accurate, stable and comfort operation.

-  **Luffing system**
- Dead-weight luffing provides more stable luffing operation at low energy loss
  - Luffing angle:  $-2^{\circ} \sim 80^{\circ}$ .

-  **Telescopic system**
- Five-section boom is applied with basic boom length of 10.5m, fully extended boom length of 39.5m, jib length of 8 m and fully extended boom lifting height of 40m respectively. Max. lifting height is 48m including jib. It is made of fine grain high-strength steel with U-shaped cross section and with telescopic operation controlled independently by dual- cylinder rope.

## Superstructure

-  **Slewing system**
- 360° rotation can be achieved with Max. slewing speed of 2r/min, providing stable and reliable operation of the system.

-  **Hoisting system**
- The winch adopts the high-pressure automatic variable plunger motor, enabling automatic switch-over between low load high speed mode and high load low speed mode and ensuring highly efficient operation and stable lifting and lowering of the load.
  - One main hook: 320Kg, one auxiliary hook: 90Kg. Wire rope of main winch: left-handed wire rope 16-35W×7-1960, with length of 200m. Wire rope of auxiliary winch: left-handed wire rope 16-35W×7-1960, with length of 105m.

-  **Safety system**
- Load moment limiter: Load moment limiter calculation system based on lifting load mechanical model is established using an analytical mechanics method with rated lifting accuracy up to  $\pm 3\%$  through on-line non-load calibration, providing full protection to lifting operation. In case of overload operation, system will automatically issue an alarm to provide safety protection for manipulation.
  - Hydraulic system is configured with the balance valve, overflow valve and two-way hydraulic lock etc. components, thus achieving the stable and reliable operation of the hydraulic system.
  - Main and auxiliary winches are equipped with over roll-out limiter to prevent over rolling-out of wire rope.
  - Boom and jib ends are equipped with height limiters respectively to prevent over-hoisting of wire rope.
  - Equipped with length sensor, angle sensor and press sensor to indicate the working condition of whole crane in real-time, giving an alarm and cutting off the dangerous action automatically.

-  **Counterweight**
- Counterweight is 4500kg, no flexible counterweight.

## Chassis

-  **Cab**
- Cab is made of new steel structure self-developed by SANY, featuring excellent shock absorption and tightness, which is configured with swing-out doors at both sides, pneumatically suspended driver's seat and passenger's seat, adjustable steering wheel, large rearview mirror, comfortable driver's chair with a headrest, anti-fog fan, air conditioner, stereo radio and complete control instruments and meters, providing more comfortable, safe and humanized operation experience.
-  **Carrier frame**
- Designed and manufactured by SANY, anti-torsion box structure is welded by fine-grain high-strength steel plate to provide strong load bearing capacity.
-  **Axles**
- Axles 2 and 3 are drive axles and axles 1 is steering axles, axle and wheel differentials are installed in axles 2 and 3. The use of welding process for axle housing provides stronger load bearing capacity.
-  **Engine**
- Type: Inline six-cylinder, water cooled, supercharged and inter-cooling diesel engine
  - Rated power: 213kW/2100(r/min)
  - Environment-protection: Emission complies with EuroIII standard
  - Capacity of fuel tank: 300L.
-  **Transmission system**
- Gearbox: Manual gearbox is adopted, with 9-gear and large speed ratio range applied, which meets the requirements of low gradeability speed and high traveling speed.
  - Transmission shaft: With optimized arrangement of the transmission shaft, the transmission is stable and reliable.
  - For most optimized transmission, plate flange is used with large transmission torque.
-  **Brakes system**
- Air serve brakes are used for all wheels with dual-circuit brake system applied. Engine is equipped with an exhaust brake.
-  **Suspension system**
- All axles adopt the plate spring suspension systems with plate spring passed 100,000 fatigue tests and with optimization of performance parameters of the front and rear plate springs applied to ensure strength and also to provide comfort ridding.
-  **Steering system**
- Hydraulic power mechanical steering systems are applied for axles 1 with unloading valve installed in the steering gear.
-  **Outriggers**
- Four-point supporting of the H-shaped outriggers ensures easy operation and strong stability with Max. span up to 5.3m×6.2m. They are made of fine-grain high-strength steel sheet. Full hydraulic transverse telescopic outriggers are adopted for flexible outriggers.
-  **Tyres**
- 11 (number of tyres) - type: 11.00-20, bias tires are used, featuring with large bearing capacity and durable use.
-  **Electrical system**
- With 2\*12V maintenance-free batteries, the crane power can be cut off manually via a mechanical master power switch.

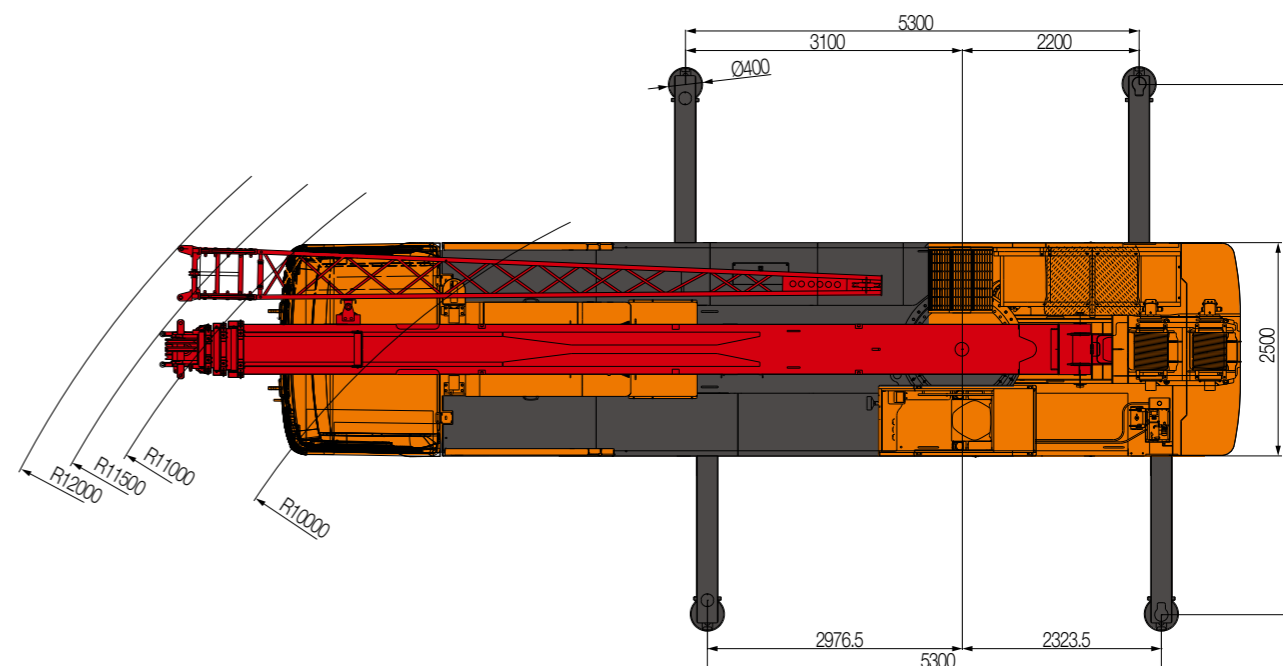
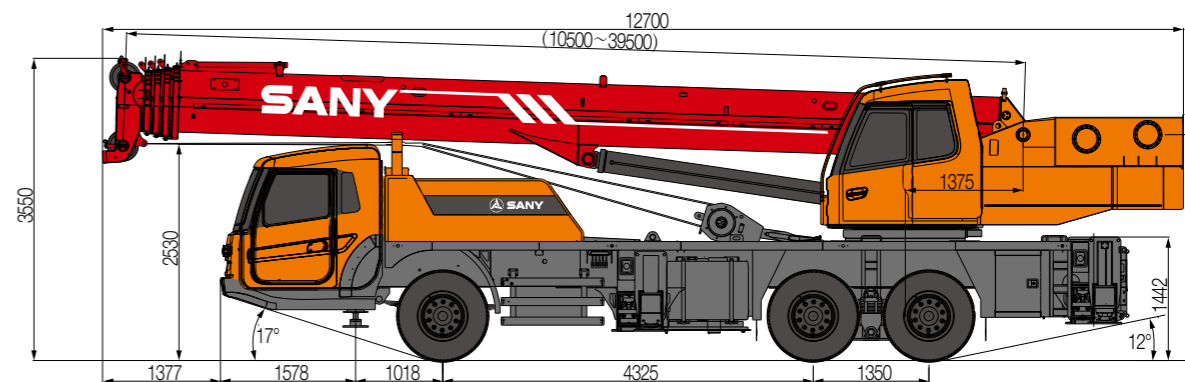

Type	Item	Parameter	
Capacity	Max. lifting capacity	25t	
Dimensions	Overall length	12700mm	
	Overall width	2500mm	
	Overall height	3550mm	
	Axle distance	Axle-1,2 Axle-2,3	4325mm 1350mm
Weight	Overall weight	33000kg	
	Axle load	Axle load-1 Axle load-2,3	7000kg 26000kg
	Rated power	213 kW/ 2100 rpm	
	Rated torque	1050N.m/ (1200 ~ 1400)rpm	
	Max.traveling speed	80km/h	
Traveling	Turning radius	Min.turning radius Min.turning radius of boom head	11m 12m
	Wheel formula	6 × 4	
	Min.ground clearance	220mm	
	Approach angle	17 °	
	Departure angle	12 °	
	Max.gradeability	38%	
	Fuel consumption per 100km	≤ 40L	
	Temperature range	- 30 °C~ + 60 °C	
Main Performance Data	Min.rated range	3m	
	Tail slewing radius of swingtable	3.37m	
	Boom section	5	
	Boom shape	U-shaped	
	Max.lifting moment	Base boom	980 kN·m
		Full-extend boom	470 kN·m
		Full-extend boom+jib	378kN·m
	Boom length	Base boom	10.5m
		Full-extend boom	39.5m
		Full-extend boom+jib	47.5m
	Outrigger span (Longitudinal×Transversal)	5.3 × 6.2m	
Jib offset	0 °, 15 °, 30 °		
Working speed	Max.single rope lifting speed of main winch (no load)	≥ 120m/min	
	Max.single rope lifting speed of auxiliary winch (no load)	≥ 120m/min	
	Full extension/retraction time of boom	105 / 120 s	
	Full lifting/descending time of boom	45 / 70 s	
	Slewing speed	(0~2)r/min	
Aircondition	Aircondition in up cab	Cooling and Heating	
	Aircondition in low cab	Cooling and Heating	

STC250H Working Ranges

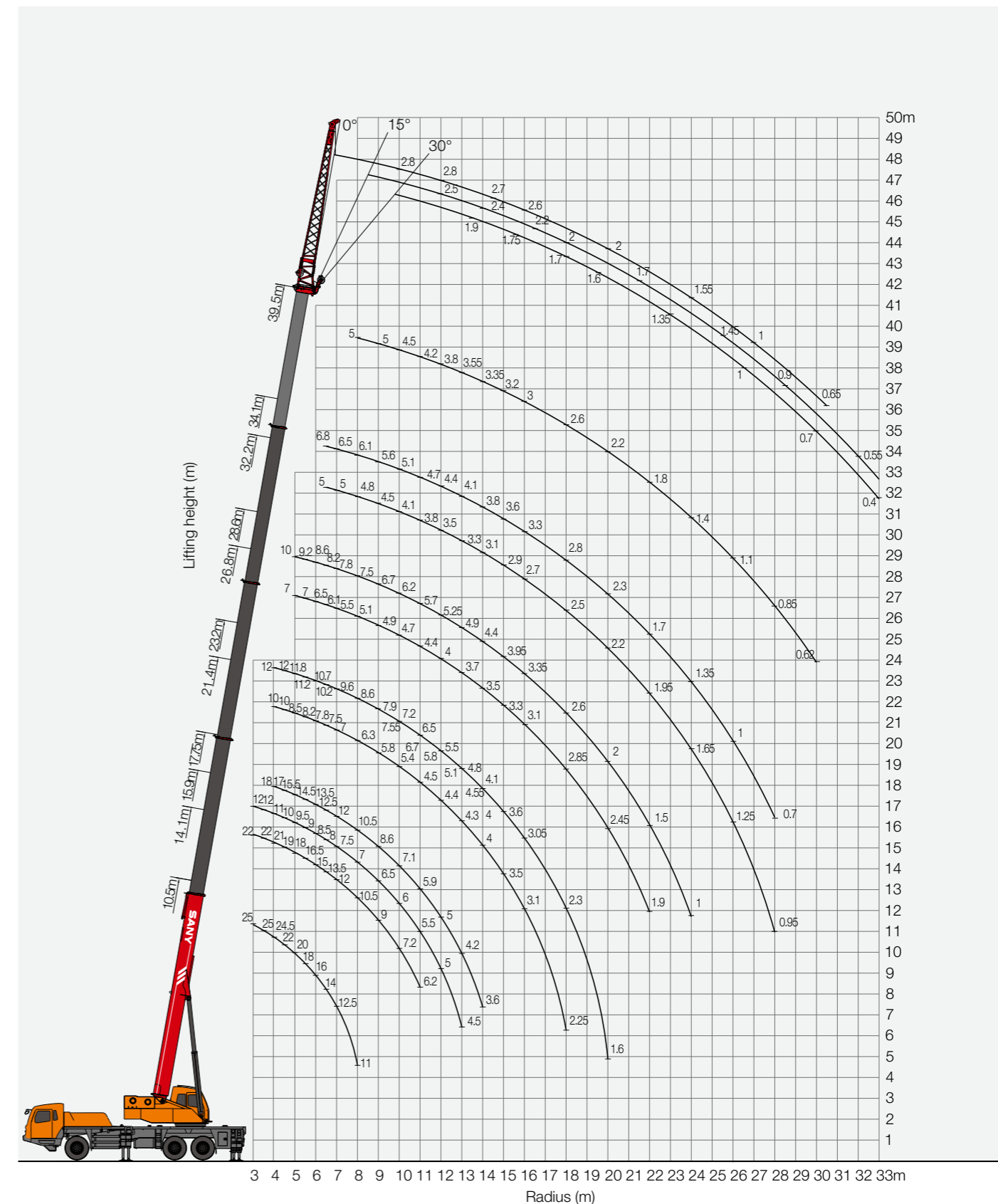

Unit:Kg

## Prerequisites:

- ① Boom operating condition (fully extended boom length), min. length is 10.5m and max. length is 39.5m
- ② The span of outrigger is 5.3m×6.2m
- ③ 360° rotation is applied
- ④ Counterweight is 4.5T

Working range(m)	Main boom											Working range(m)
	10.5m	14.1m	15.9m	17.75m	21.4m	23.2m	26.8m	28.6m	32.2m	34.1m	39.5m	
3	25000	22000	12000									3
3.5	25000	22000	12000									3.5
4	24500	21000	11000	18000	10000	12000						4
4.5	22000	19000	10000	17000	10000	12000						4.5
5	20000	18000	9500	15500	8500	11800	7000	10000				5
5.5	18000	16500	9000	14500	8200	11200	7000	9200				5.5
6	16000	15000	8500	13500	7800	10700	6500	8600				6
6.5	14000	13500	8000	12500	7500	10200	6100	8200	5000	6800		6.5
7	12500	12000	7500	12000	7000	9600	5500	7800	5000	6500		7
8	11000	10500	7000	10500	6300	8600	5100	7500	4800	6100	5000	8
9		9000	6500	8600	5800	7900	4900	6700	4500	5600	5000	9
10		7200	6000	7100	5400	7200	4700	6200	4100	5100	4500	10
11		6200	5500	5900	4500	6500	4400	5700	3800	4700	4200	11
12			5000	5000	4400	5500	4000	5250	3500	4400	3800	12
13			4500	4200	4300	4800	3700	4900	3300	4100	3550	13
14				3600	4000	4100	3500	4400	3100	3800	3350	14
15					3500	3600	3300	3950	2900	3600	3200	15
16					3100	3050	3100	3350	2700	3300	3000	16
18					2250	2300	2850	2600	2500	2800	2600	18
20						1600	2450	2000	2200	2300	2200	20
22							1900	1500	1950	1700	1800	22
24								1000	1650	1350	1400	24
26									1250	1000	1100	26
28									950	700	850	28
30											620	30
Number of lines	8	8	6	6	4	4	4	4	4	4	3	Number of lines
Telescoping condition(%)												
I	0	50%	0	100%	0	100%	0	100%	0	100%	100%	I
II	0	0	25%	0	50%	25%	75%	50%	100%	75%	100%	II
III	0	0	25%	0	50%	25%	75%	50%	100%	75%	100%	III
IV	0	0	25%	0	50%	25%	75%	50%	100%	75%	100%	IV

1. Value specified in table is rated lifting capacity of the crane under the condition that the crane parks on the flat and solid ground under leveling state.
2. Values above the thick solid line are determined by the strength of the crane and below the thick solid line are determined by the stability of the crane.
3. Rated lifting capacity determined by the stability shall comply with ISO4305.
4. Rated lifting capacity in the table includes the weights of lifting hook and hanger (main hook: 320kg; auxiliary hook: 90kg).
5. Rated lifting capacity when pulley at boom tip is used can not exceed 3500 kg, after the jib installs, rated lifting capacity of the boom shall be a value that a total is subtracted by the weight of jib (450kg).
6. If actual boom length and range are both between two values in the table, the larger value is used to determine the lifting capacity.

Unit:Kg



















## Prerequisites:

- ① Boom operating condition (fully extended boom length + jib length), max. length is 39.5m+8m
- ② The span of outrigger is 5.3m×6.2m
- ③ 360° rotation is applied
- ④ Counterweight is 4.5T

Main boom angle	Main boom+Jib		
	Compensation angle 0°	Compensation angle 15°	Compensation angle 30°
78°	2800	2500	1900
75°	2800	2400	1750
72°	2700	2200	1700
70°	2600	2000	1600
65°	2000	1700	1350
60°	1550	1450	1000
55°	1000	900	700
50°	650	550	400

# STC250H TRUCK CRANE WHEEL CRANE FAMILY MAP

## TRUCK CRANE

 STC200 Maximum Load Capacity: 20t Telescopic Boom: 4 Sections, 10.6-33m	 STC250 Maximum Load Capacity: 25t Telescopic Boom: 4 Sections, 10.65-33.5m	 STC250H Maximum Load Capacity: 25t Telescopic Boom: 5 Sections, 10.5-39.5m	 STC300S Maximum Load Capacity: 30t Telescopic Boom: 5 Sections, 10.6-40.5m	 STC300TH Maximum Load Capacity: 30t Telescopic Boom: 4 Sections, 10.6-33.5m
 STC300H Maximum Load Capacity: 30t Telescopic Boom: 5 Sections, 10.5-39.5m	 STC500 Maximum Load Capacity: 50t Telescopic Boom: 5 Sections, 11.5-43m	 STC550 Maximum Load Capacity: 55t Telescopic Boom: 5 Sections, 11.5-43m	 STC600S Maximum Load Capacity: 60t Telescopic Boom: 5 Sections, 11.3-43.5m	 STC750 Maximum Load Capacity: 75t Telescopic Boom: 5 Sections, 11.6-46m
 STC800S Maximum Load Capacity: 80t Telescopic Boom: 5 Sections, 12.2-47m	 STC1000 Maximum Load Capacity: 100t Telescopic Boom: 5 Sections, 13.5-52m	 STC1000C Maximum Load Capacity: 100t Telescopic Boom: 6 Sections, 13.25-60m	 STC1000S Maximum Load Capacity: 100t Telescopic Boom: 5 Sections, 12.26-66m	 STC1200S Maximum Load Capacity: 120t Telescopic Boom: 7 Sections, 12.6-63.5m
 STC1300C Maximum Load Capacity: 130t Telescopic Boom: 6 Sections, 13.3-60m	 STC1600 Maximum Load Capacity: 160t Telescopic Boom: 6 Sections, 13.4-62m	 STC2200 Maximum Load Capacity: 220t Telescopic Boom: 6 Sections, 14.55-68m		

## ALL TERRAIN CRANE

 SAC1800 Maximum Load Capacity: 180t Telescopic Boom: 6 Sections, 13.5-62m	 SAC2200 Maximum Load Capacity: 220t Telescopic Boom: 6 Sections, 13.5-62m	 SAC2600 Maximum Load Capacity: 260t Telescopic Boom: 6 Sections, 15.65-73m	 SAC3000 Maximum Load Capacity: 300t Telescopic Boom: 7 Sections, 15.4-80m
 SAC3500 Maximum Load Capacity: 350t Telescopic Boom: 6 Sections, 15.2-70m	 SAC6000 Maximum Load Capacity: 600t Telescopic Boom: 7 Sections, 17.1-90m		

## ROUGH-TERRAIN CRANE

 SRC250 Maximum Load Capacity: 25t Telescopic Boom: 4 Sections, 9.9-31.5m	 SRC350 Maximum Load Capacity: 35t Telescopic Boom: 4 Sections, 10-31.5m	 SRC550 Maximum Load Capacity: 55t Telescopic Boom: 4 Sections, 11.25-34.5m	 SRC550H Maximum Load Capacity: 55t Telescopic Boom: 5 Sections, 11.5-42m	 SRC750 Maximum Load Capacity: 75t Telescopic Boom: 5 Sections, 11.6-45m
 SRC1200 Maximum Load Capacity: 120t Telescopic Boom: 5 Sections, 13-48m				





Quality Changes the World

## SANY AUTOMOBILE HOISTING MACHINERY

Address: SANY Industrial Park, Jinzhou Development Zone,  
Changsha, Hunan, China.  
Service Hotline: 4006098318  
Email: [crd@sany.com.cn](mailto:crd@sany.com.cn)  
For more information, please visit: [www.sanygroup.com](http://www.sanygroup.com)

For our consistent improvement in technology, specifications may change without notice.  
The machines illustrated may show optional equipment which can be supplied at additional cost.

Version: 2015.08

Distributed By: