

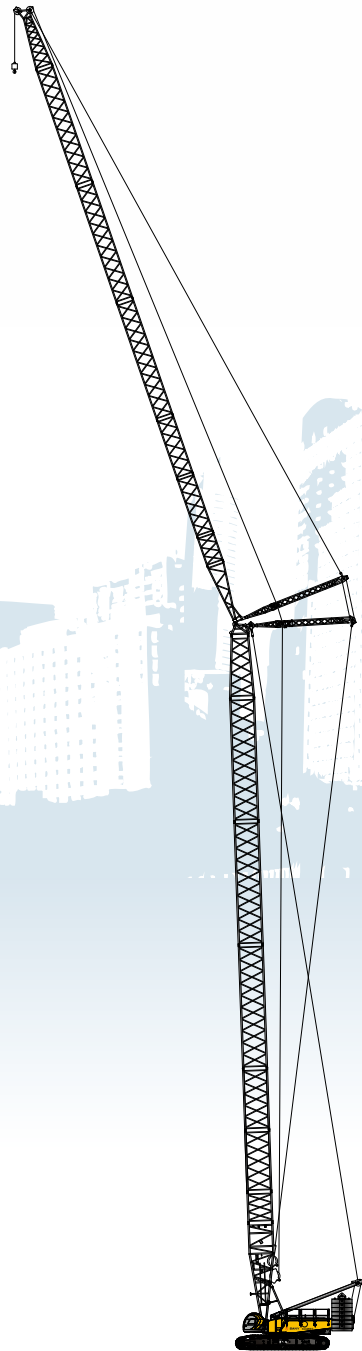

SANY

Quality Changes the World



SANY CRAWLER CRANE SCC 2600A

CRAWLER CRANE

CONTENTS

P2

SCC2600A Crawler Crane

- Outline Dimensions
- Main Technical Features
- Main Performance Data
- Transport Dimensions
- Transporting scheme
- Assembly and disassembly diagram

P16

Specifications

- Superstructure
- Undercarriage
- Operation Devices
- Safety Devices

P23

Operating Condition Combination

- Operating Condition Combination
- H Operating Condition
- Fixed Jib Combination
- Luffing Jib Combination
- Shield Operating Condition Load Charts

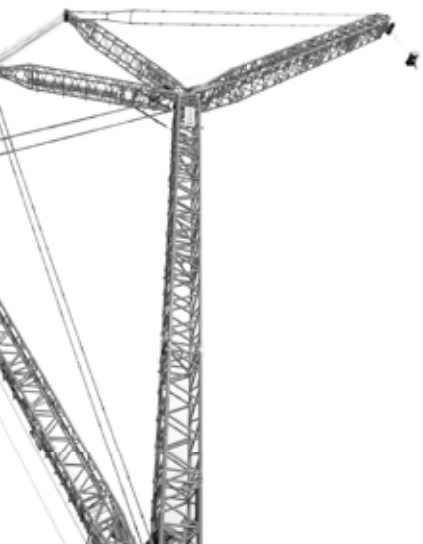

SCC2600A

02	Outline Dimensions
03	Main Technical Features
04	Main Performance Data
05	Transport Dimensions
10	Transporting scheme
12	Assembly and disassembly diagram

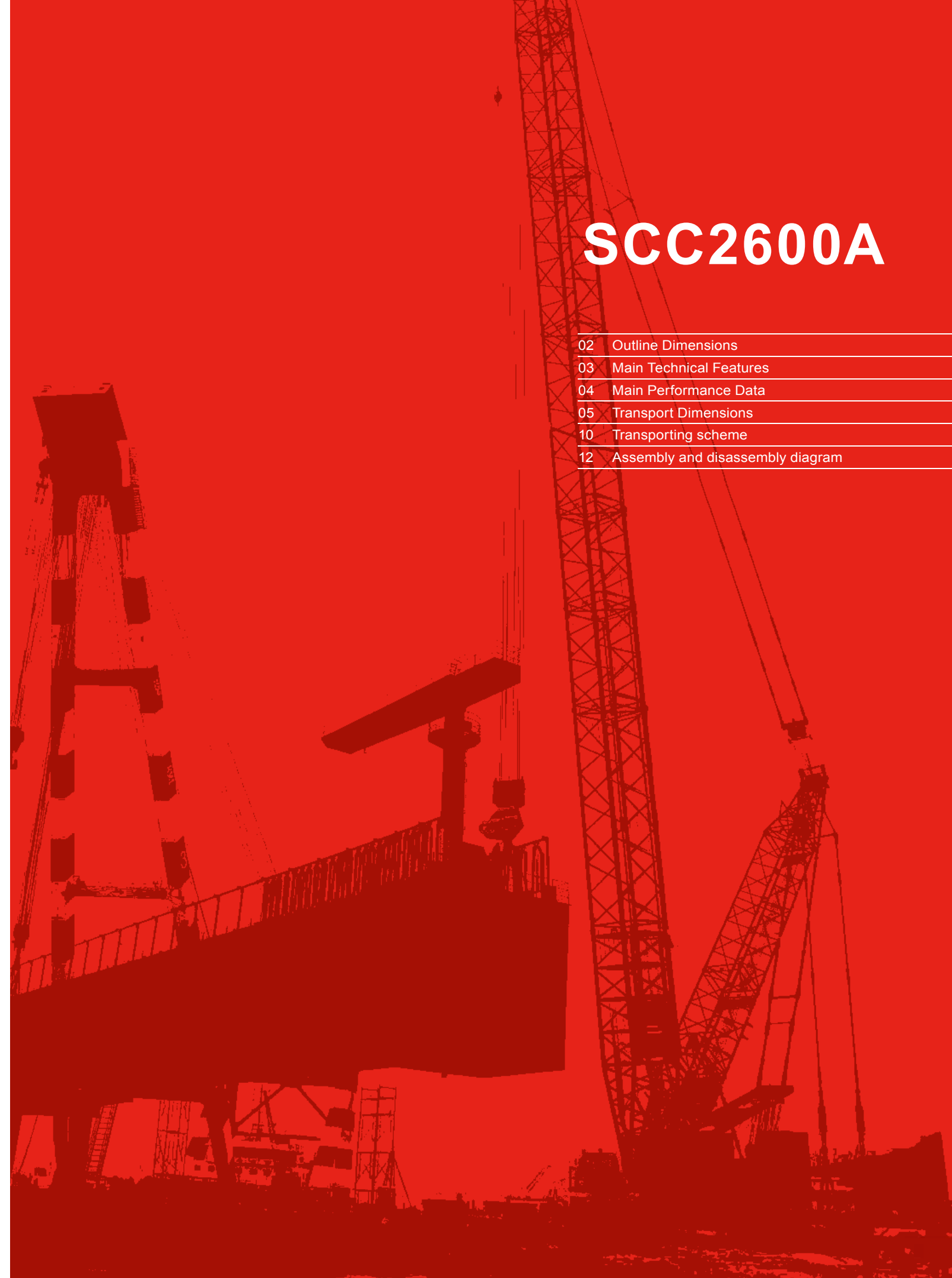

OUTLINE DIMENSIONS

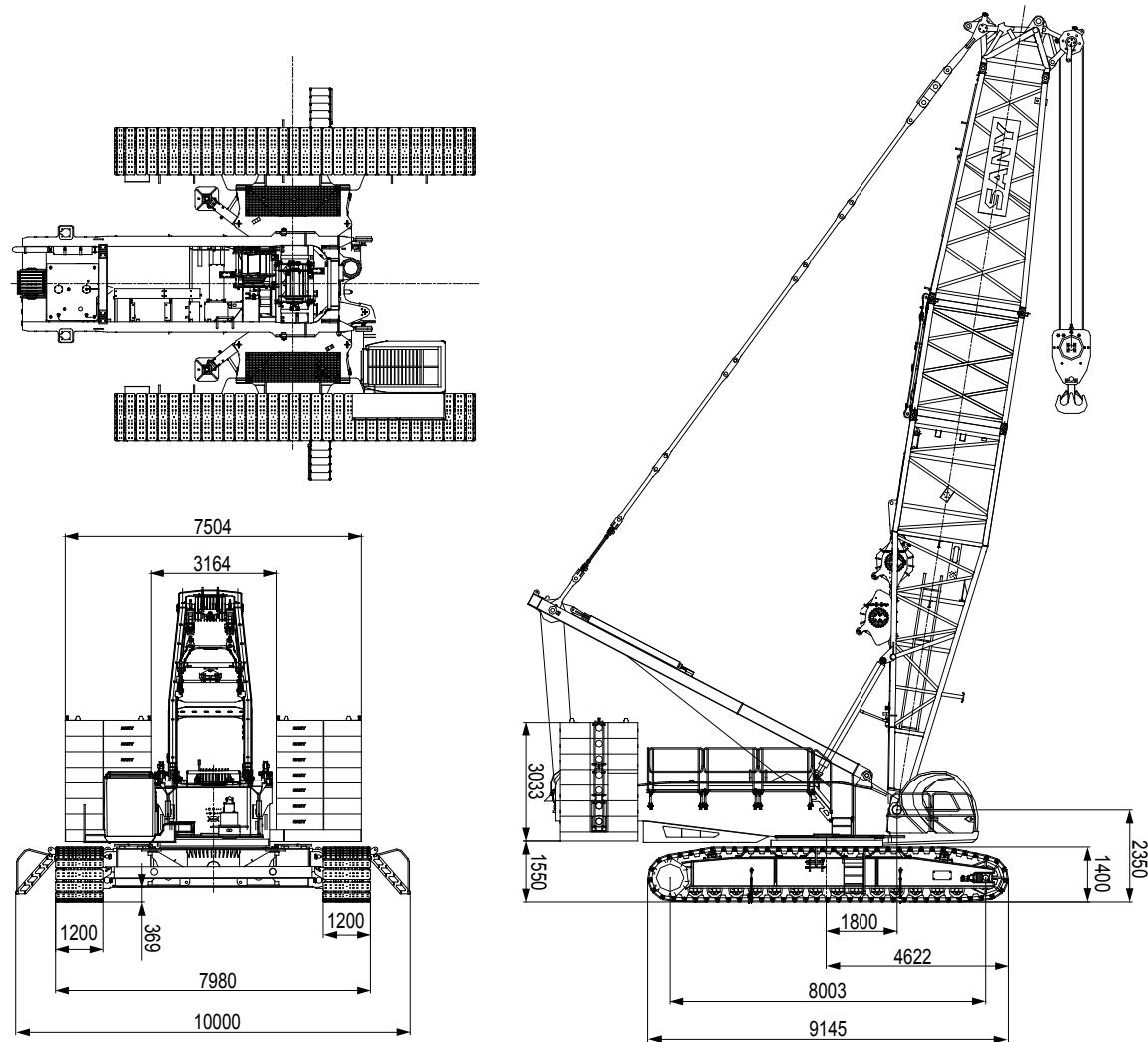

MAIN TECHNICAL FEATURES

1. Safety Control System:

There are two convenient and reliable operation modes, working and assembly. The electronic level indicator and bubble level indicator are equipped to ensure dual protection for real-time display. It has the leaving-machine stop action, emergency electrical control, lightning protection, walking automatically steering and closed circuit monitoring functions, with the complete safety and monitoring system;

2. New Lift Operating Condition Design:

The operating condition of 20m boom + 12m heavy fixed jib is adopted, to meet the lifting requirement of shield machine used for subway construction and similar products. The turning-over operation of shield machine can be automatically done, without the auxiliary crane. The auxiliary hook is larger enough to lift the heavy object up to 96T. The load moment limiter indicator can dynamically reflect the loading capacities of main and auxiliary hooks;

3. Beautiful and Comfortable Cab:

The cab is beautiful, comfortable and safe;

4. Superior Operating Performance:

The load sensor, limit load regulation and electronic-over-hydraulic control can ensure the best all actions excellent action and stability.;

5. Reliable Function Assurance:

The designed safety margin for structures and mechanisms are sufficient; and the control system can operate stably in the cold, high temperature, plateau, and large sand harsh environment;

6. Convenient Maintenance Technology:

It takes approximately no more than 10min/person to adjust;no more than 30min/person for daily maintenance;no more than 2h/ person to repair.GPS remote monitoring system is optional for maintenance and management.;

7. Powerful Lifting Capacity:

The maximum boom lifting moment is $183.8t \times 8m = 1470.4t \cdot m$ and the longest boom length is 86m; the maximum lifting capacity of luffing jib is $62.5t \times 18m = 1125t \cdot m$ and the longest boom combination length is 62 m+63m;

8. High Efficient Self-Handling Technology:

A button can be cocked to easily lift the mast, to ensure the clutch traction winch reeving operation. It can support the machine self-dismounting operation; and the quick-change rope connectors and winch rope head are can be used;

9. Large Chassis Design:

The chassis with the track gauge of 6.7m is adopted, to ensure the excellent operation stability within the range of 360° rotation;

10. Globalization of Transportation Standards:

The transport weight of main machine is limited within 45 tons, the transport width is less than 3m and the transport height is less than 3.2m, thus saving the transport cost significantly;

11. Powerful Traveling Capacity with Load:

The powerful traveling traction and walking stability can make the best advantage of crawler crane;

12. Reliable Transmission System:

The use of advanced hydraulic components and of load feedback control technology with independent property rights can ensure the stable and reliable operation of hydraulic system;

13. Large Fuel Tank Design:

The fuel tank capacity is 1050L, which is greatly increased compared with the old models (400L), thus avoid the frequent refueling;

14. Broad Adaptability:

In accordance with Europe and America non-road phase III emission standards and has a wide application in boat building, subway construction, metallurgy and infrastructure.

MAIN PERFORMANCE DATA

Main Performance Parameters of SCC2600A Crawler Crane			
Performance index		Unit	Parameters
Boom operating condition	Maximum lifting capacity	t	260
	Maximum rated lifting moment	t•m	1470.4
	Boom length	m	20~86
Fix jib operating jib	Boom luffing angle	°	30~85
	Longest boom + longest fixed jib	m	62+42
Heavy fixed jib operating condition	Fixed jib offset angle	°	10, 30
	Boom + fixed jib (shield operating condition)	m	20+12
Luffing jib operating condition	Angle between boom and jib	°	20
	Maximum lifting moment	t•m	62.5×18=1125
	Longest boom + longest luffing jib	m	62+63
Speed	Jib luffing angle	°	65~88
	Boom (jib) winch line speed (outmost working layer)	m/min	0~124
	Main luffing winch line speed (outmost working layer)	m/min	0~108
	Auxiliary luffing winch line speed (outmost working layer)	m/min	0~144
	Swing speed	rpm	0~1.25
	Traveling speed	km/h	0~1.2/0~0.53 (double speed)
Engine	Gradeability	%	30
	Output power	kW	242
Transportation data	Rated speed	rpm	2100
	Max. transport weight of single part (including boom and jib lifting winches)	t	45
	Transport dimension (L * W * H)	mm	13320×3000×3200
	Average ground pressure	MPa	0.14

TRANSPORT DIMENSIONS

Basic Machine	×1
Length	13.32m
Width	3.0m
Height	3.20m
Weight	45t
Track Assembly	×2
Length	9.15m
Width	1.20m
Height	1.40m
Weight	22t
Boom Head (including pulley block)	×1
Length	3.24m
Width	2.07m
Height	1.62m
Weight	3.5t
Boom Base (including winch)	×1
Length	10.35m
Width	2.60m
Height	2.99m
Weight	13.58t
3m Boom Insert	×1
Length	3.18m
Width	2.65m
Height	2.66m
Weight	1.3t
6m Boom Insert	×1
Length	6.18m
Width	2.65m
Height	2.66m
Weight	2.0t
12m Boom Insert	×5
Length	12.18m
Width	2.65m
Height	2.66m
Weight	3.6t

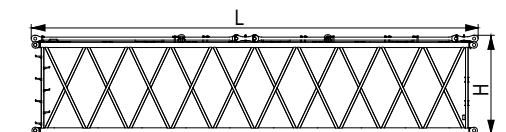
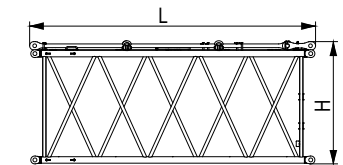
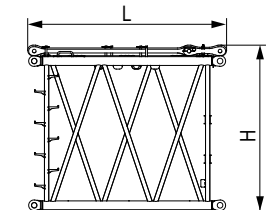
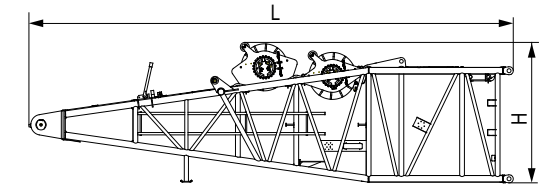
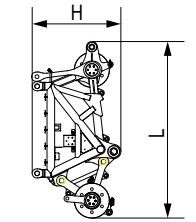
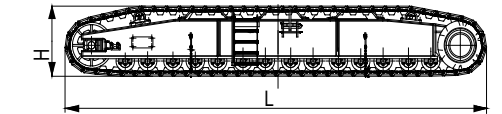
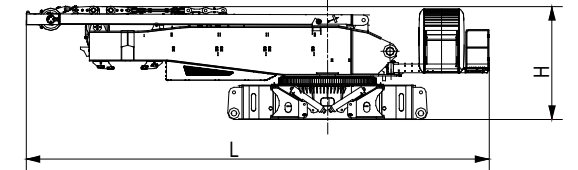

TRANSPORT DIMENSIONS

6m Transitional Boom Insert	×1
Length	6.20m
Width	2.65m
Height	2.66m
Weight	2.0t
Luffing Jib Tip	×1
Length	6.46m
Width	2.12m
Height	2.10m
Weight	2.4t
3m Luffing Jib Insert	×1
Length	3.17m
Width	2.12m
Height	1.91m
Weight	0.63t
6m Luffing Jib Insert	×1
Length	6.17m
Width	2.12m
Height	1.91m
Weight	1.04t
6m Luffing Jib Insert	×1
Length	6.17m
Width	2.12m
Height	1.91m
Weight	1.05t
12m Luffing Jib Insert	×3
Length	12.17m
Width	2.12m
Height	1.91m
Weight	1.95t
Boom Extension	×1
Length	2.2m
Width	0.95m
Height	1.44m
Weight	0.42t

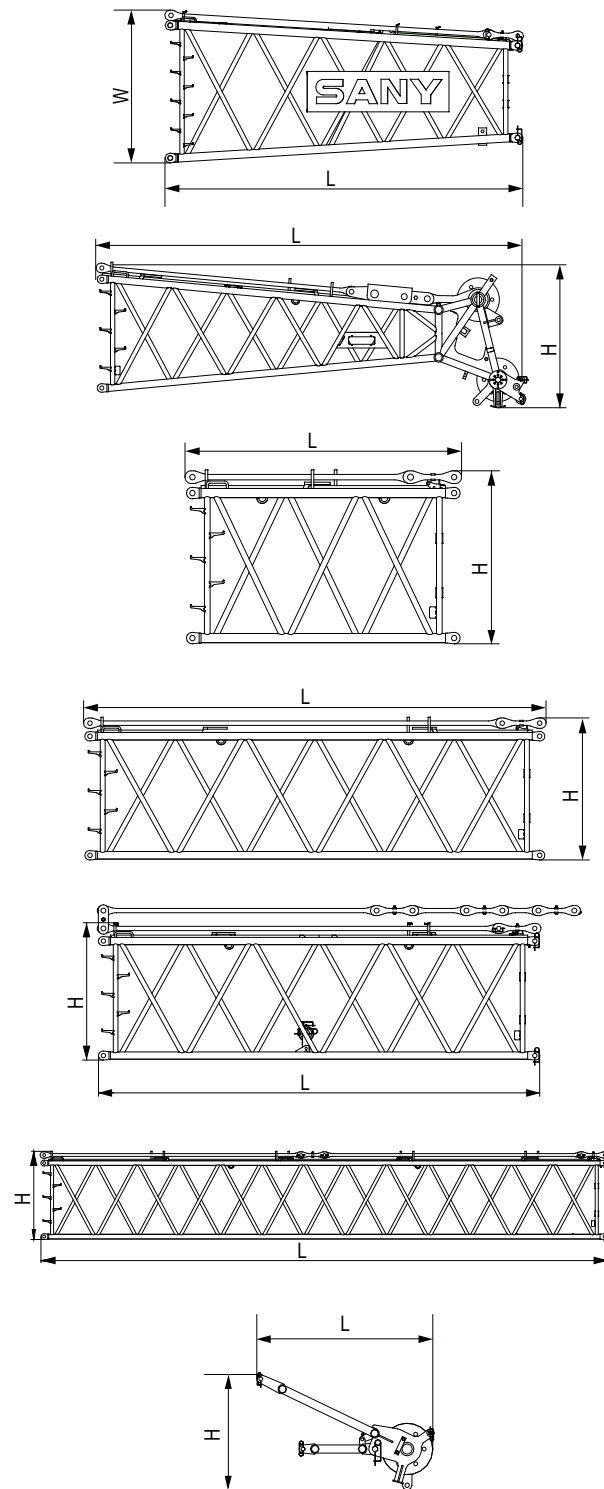

TRANSPORT DIMENSIONS

Jib Base, Luffing Front and Rear Masts	×1
Length	11.49m
Width	2.11m
Height	3.26m
Weight	5.5 t
6m Fixed Jib Insert	×1
Length	6.11m
Width	1.50m
Height	1.42m
Weight	0.75t
11.5m Fixed Jib Insert	×2
Length	11.67m
Width	1.50m
Height	1.42m
Weight	1.3 t
Fixed Jib Base and Mast	×1
Length	6.70m
Width	1.42m
Height	2.00m
Weight	1.75t
Fixed Jib Tip	×1
Length	7.10m
Width	1.42m
Height	1.43m
Weight	1.75t
Carbody Counterweight	×2
Length	5.48m
Width	1.72m
Height	0.60m
Weight	15t
Counterweight Tray	×2
Length	7.50m
Width	1.96m
Height	0.70m
Weight	16t

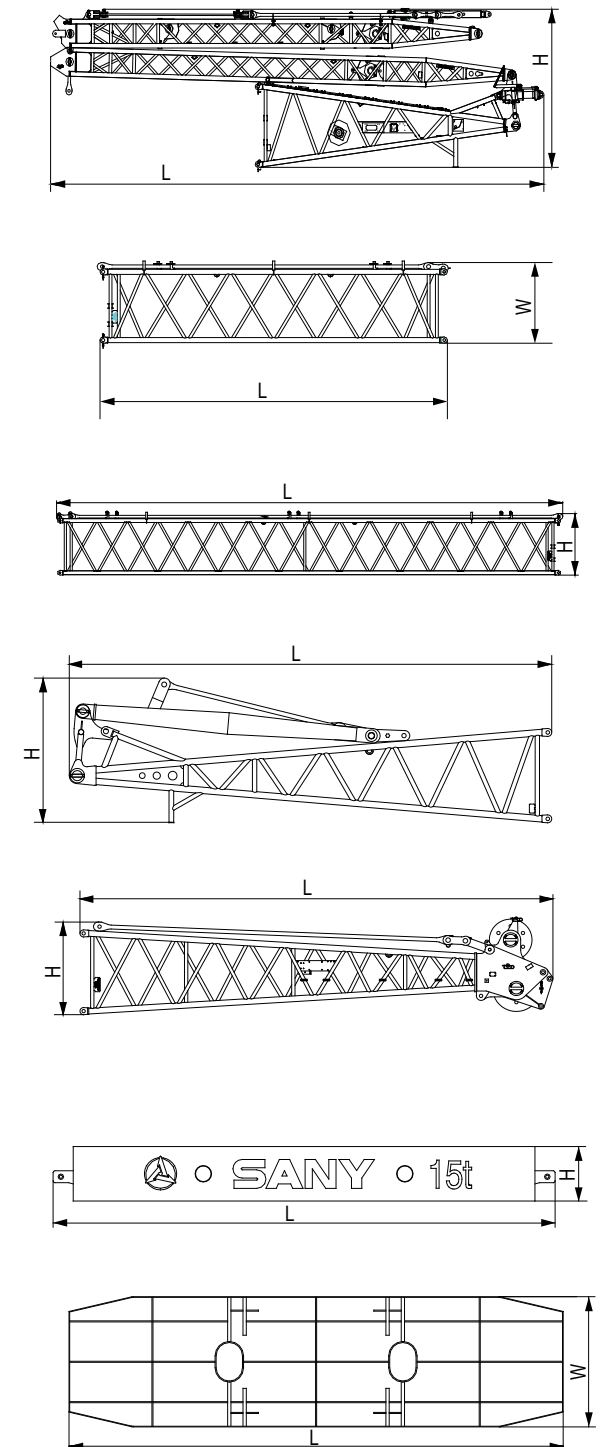

TRANSPORT DIMENSIONS

6t Counterweight Block	×14
Length	2.17m
Width	1.96m
Height	0.51m
Weight	6t
Dolly	×1
Length	2.56m
Width	1.74m
Height	1.00m
Weight	1t
260t Hook	×1
Length	1.04m
Width	1.02m
Height	2.93m
Weight	5.2t
160t Hook	×1
Length	0.59m
Width	1.02m
Height	2.64m
Weight	3.2t
100t Hook	×1
Length	0.51m
Width	1.02m
Height	2.48m
Weight	2.3t
50t Hook	×1
Length	0.45m
Width	1.02m
Height	2.30m
Weight	1.7t

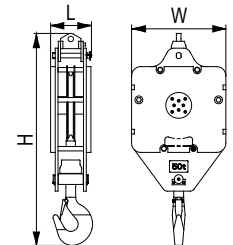
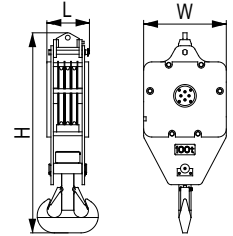
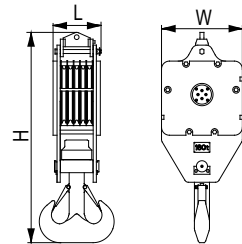
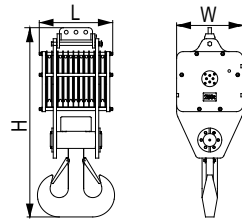
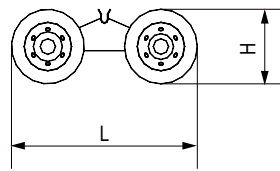
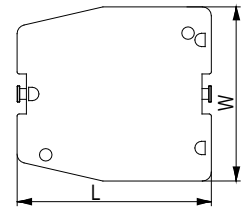

TRANSPORT DIMENSIONS

16t Hook	×1
Length	0.53m
Width	0.57m
Height	1.10m
Weight	0.9 t

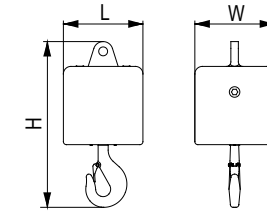

- Notes: 1. The transport dimensions of the parts are marked on schematic diagrams, but not drawn by scale; the dimensions indicated are the design values excluding package.
2. The weight is the design value and there may be difference due to the manufacturing error.

TRANSPORTING SCHEME

Platform lorry 498-16165 Rated load: 49.8t

Transport part Basic crane

Transport weight 45t

Quantity 1

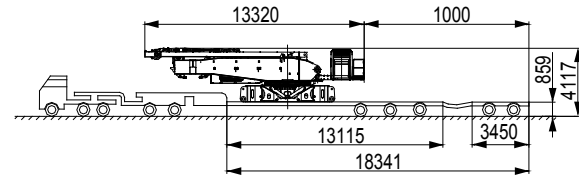

Platform lorry 395-16165 Rated load: 39.5t

Transport part Left track frame assembly

Transport weight 22t

Quantity 1

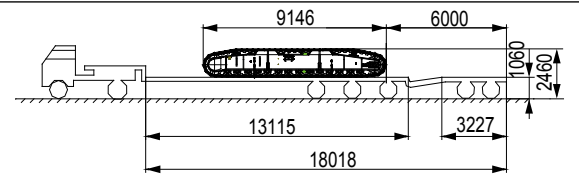

Platform lorry 395-16165 Rated load: 39.5t

Transport part Right track frame assembly

Transport weight 22t

Quantity 1

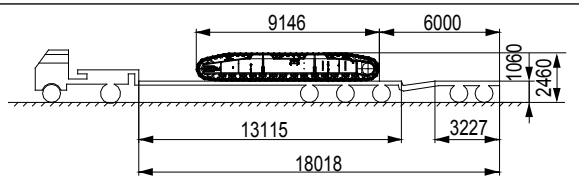

Platform lorry 20-14630 Rated load: 20t

Transport part Counterweight tray × 1, 6m luffing jib intermediate section 1 and 6m luffing jib intermediate section

Transport weight 17.7t

Quantity 1

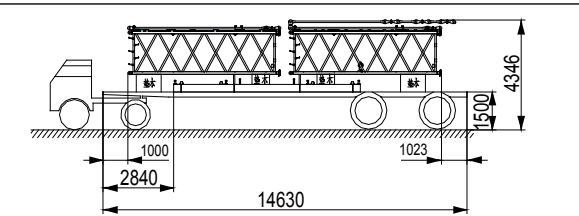

Platform lorry 20-14630 Rated load: 20t

Transport part Central ballast frame × 1, 6m boom intermediate section × 1 and 3m luffing jib intermediate section × 1

Transport weight 18t

Quantity 1

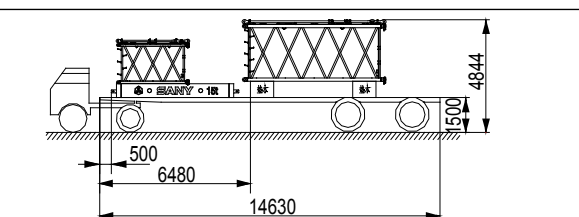

Platform lorry 20-14630 Rated load: 20t

Transport part Counterweight block × 2 and 12m boom intermediate section × 1

Transport weight 15.7t

Quantity 5

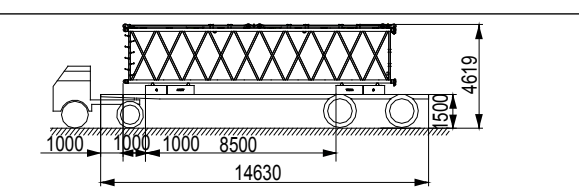

Platform lorry 20-14630 Rated load: 20t

Transport part Counterweight block × 2, 12m luffing jib intermediate section × 1 and 50T hook × 1

Transport weight 15.2t

Quantity 1

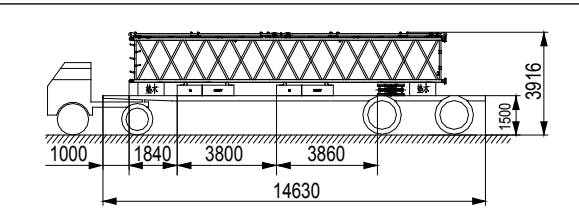

TRANSPORTING SCHEME

Platform lorry 20-14630 Rated load: 20t

Transport part Basic crane

Transport weight 13.5t

Quantity 1

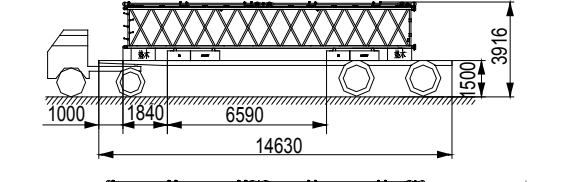

Platform lorry 20-14630 Rated load: 20t

Transport part Central ballast frame × 1, 12m luffing jib intermediate section × 1 and 16T ball hook × 1

Transport weight 18t

Quantity 1

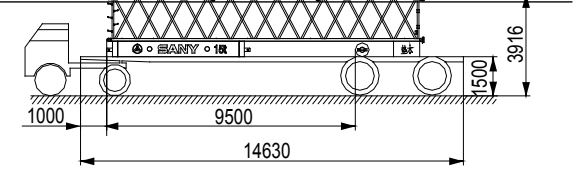

Platform lorry 20-14630 Rated load: 20t

Transport part Fixed jib 11.5m and intermediate section × 1

Transport weight 1.3t

Quantity 2

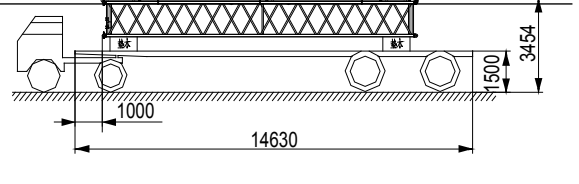

Platform lorry 20-14630 Rated load: 20t

Transport part Fixed jib base and mast × 1, fixed jib top × 1

Transport weight 2.6t

Quantity 1

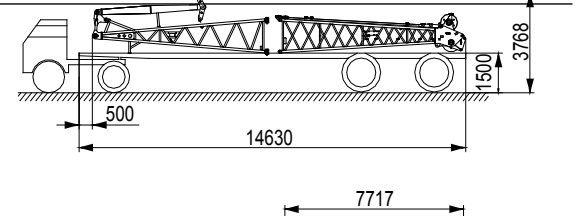

Platform lorry 20-14630 Rated load: 20t

Transport part 160T hook × 1 and boom tapered insert × 1, Boom head (with pulley block) × 1 and luffing jib top × 1

Transport weight 13t

Quantity 1

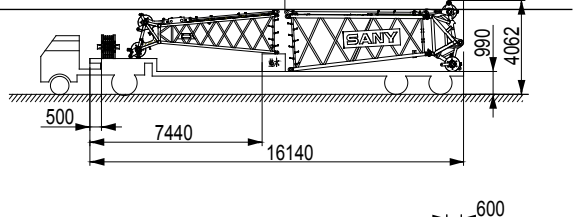

Platform lorry 20-16140 Rated load: 20t

Transport part Luffing jib base and front and rear mast assembly × 1, 100T hook × 1, 260t hook × 1 and fixed jib 6m intermediate section × 1

Transport weight 13.5t

Quantity 1

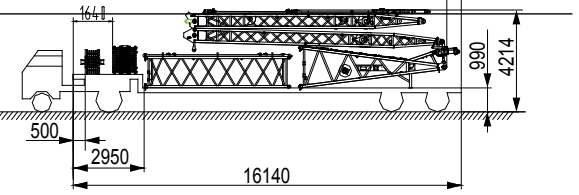

Platform lorry 20-16140 Rated load: 20t

Transport part Boom base × 1, boom 3m intermediate section × 1, boom extension × 1 and dolly × 1

Transport weight 16.7t

Quantity 1

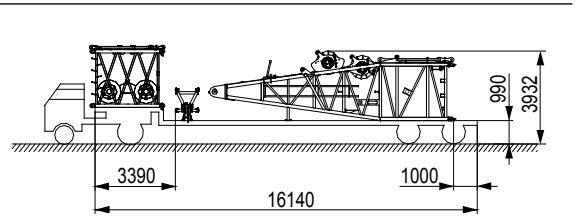

ASSEMBLY AND DISASSEMBLY DIAGRAM

1) Basic crane self-assembly

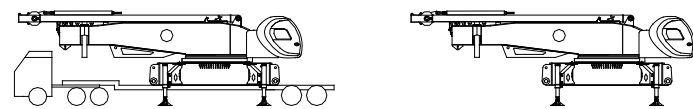
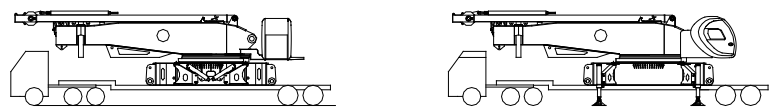

2) Track frame self-assembly

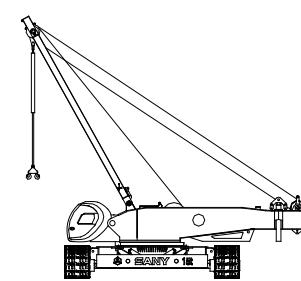
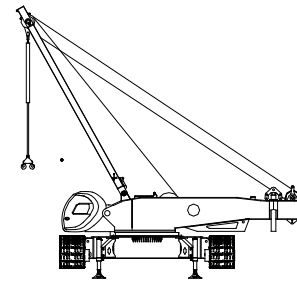
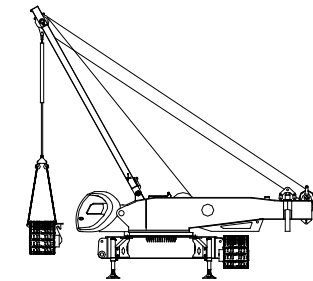
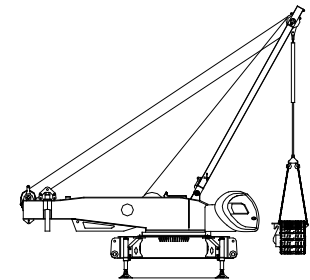
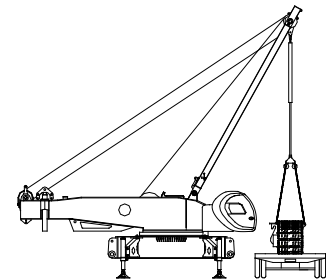
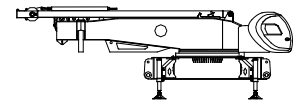

3) Counterweight self-assembly

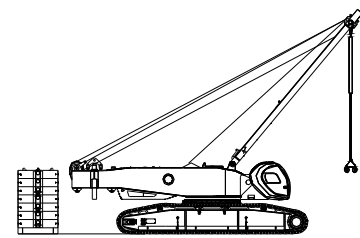
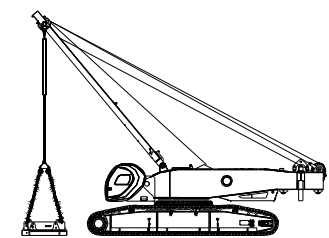
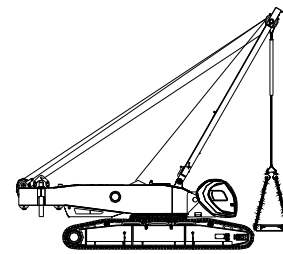
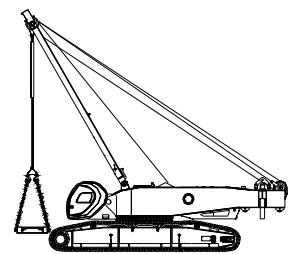
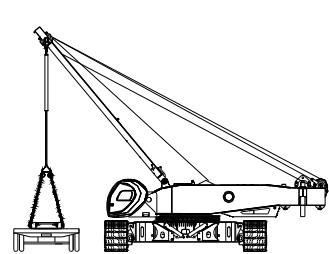

ASSEMBLY AND DISASSEMBLY DIAGRAM

4) Boom/jib base self-assembly

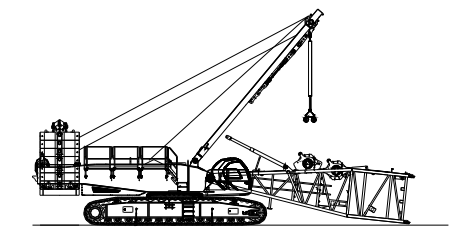
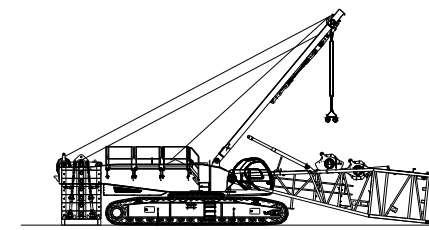
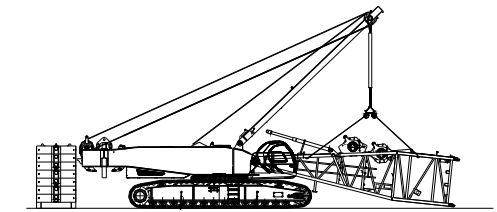
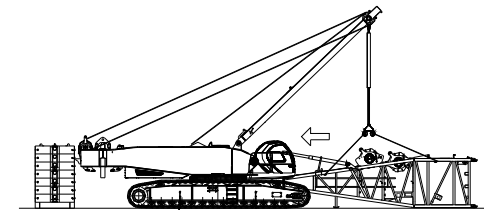

Boom frame installation diagram

1) Basic boom installation

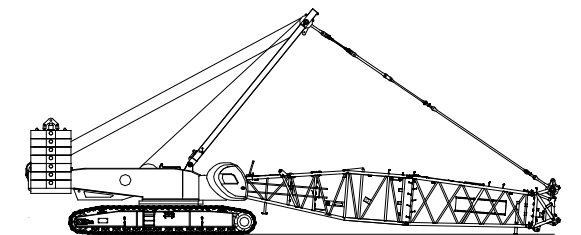
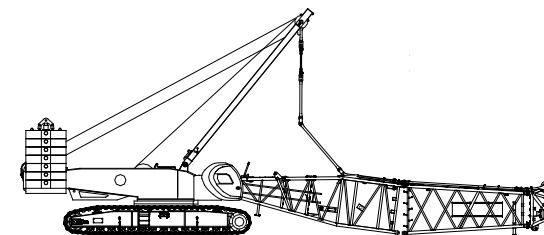

2) Jib frame installation under luffing jib operating condition

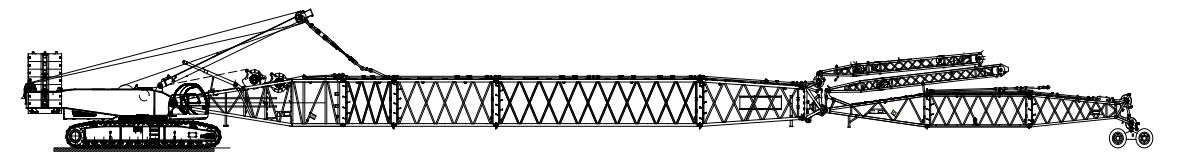
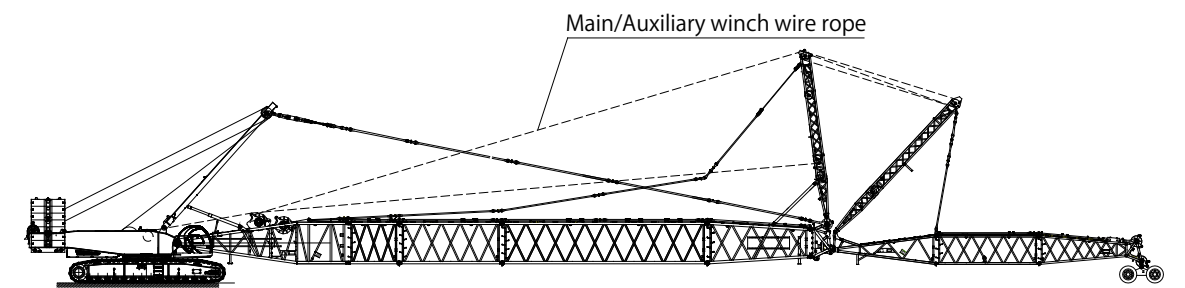

ASSEMBLY AND DISASSEMBLY DIAGRAM

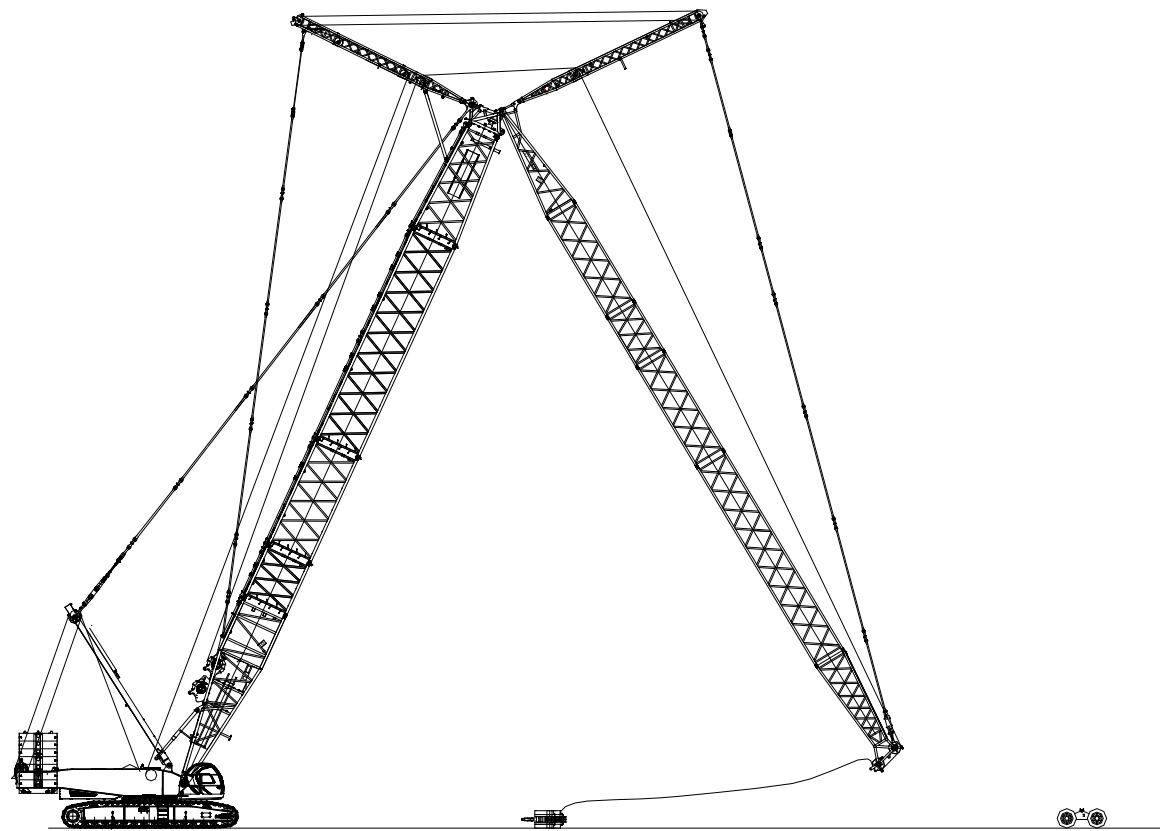

3) Jib frame installation under fixed jib operating condition

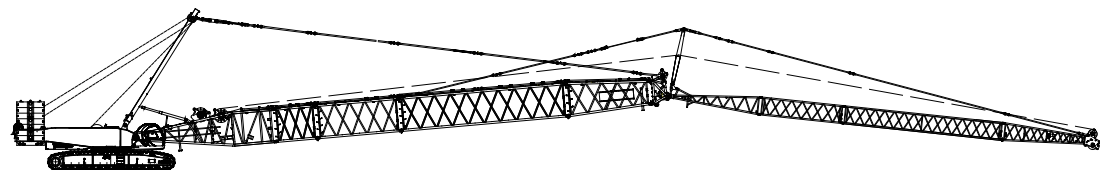
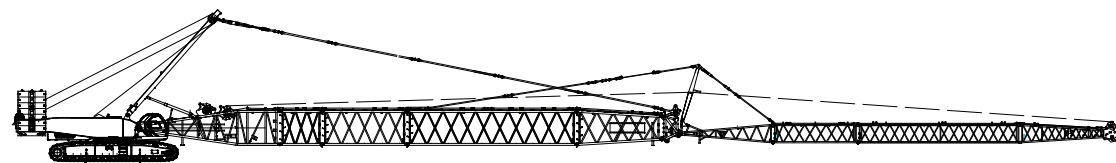

SCC2600A

Superstructure	16
Undercarriage	18
Operation Devices	19
Safety Devices	20



SUPERSTRUCTURE

1) Engine

- Diesel engine with rated power of 242kw /2100rpm.
- Emission standard: Tier III .

2) Electrical Control System

- Advanced central control unit, load moment indicator, display, sensor and closed-circuit monitoring system are adopted.
- Reliability: Advanced main electrical devices are adopted to ensure the stable operation in the cold, high temperature, plateau and large sand storm harsh environment.
- Security: Electrical design fully complies with the CE standard; the multi-level safety limit control is adopted and all safety signal indicators are complete.
- Comfortableness: The electrical parameters of all points can be seen through the combination instruments in the cab, to monitor all operating parameter and working state in real time.
- Advancement: The vehicle electrical system adopts the CAN bus system; the load power limit load control is adopted, with the calibration of redundant communications and with the optional GPS.

3) Hydraulic System

- The hydraulic system includes: Main valve hydraulic system, main lifting hydraulic structure, boom luffing hydraulic structure, jib luffing hydraulic structure, and auxiliary hydraulic structure. .
- Features: The main system is of open circuit, widely adopting the electronic proportional control components. The system adopts the load sensitive LUDV system, which can achieve the flow distribution irrelevant with load. The hydraulic proportional pilot control is adopted, which is characterized by the sensitive operation and good micro-mobility.
- The system pressure is 32MPa.

4) Main and Auxiliary Hoisting Devices

- The boom and jib winch mechanisms can be driven separately, which is characterized by the compact structure, easy installation, and low wear. The maintenance-free built-in wet brake can ensure the safety of winch.
- The displacement of variable hydraulic motor of lifting mechanism can be automatically adjusted according to the load, to achieve the maximum winch speed.
- The high-quality anti-rotation wire rope is adopted, to ensure the high lifting safety and long life.
- The pouch socket with swaged sleeve is adopted to ensure the convenient and quick dismounting of wire rope.

NO.1 Main lifting device

Outermost working layer rope speed	0~110 m/min
Diameter of wire rope	28 mm
Length of wire rope of boom winch	480m
Rated single line pull	17t

NO.2 Auxiliary lifting device

Outermost working layer rope speed	0~110 m/min
Diameter of wire rope	28 mm
Length of wire rope of boom winch	390m
Rated single line pull	17t

5) Boom Luffing Device

The boom luffing drum is equipped with the ratchet pawl locking device, to ensure the parking safety of boom under non-working state.

NO.3 Boom luffing device

Outermost working layer rope speed	0~121m/min
Diameter of wire rope	28mm
Length of boom luffing wire rope	310m
Rated single line pull	17t

6) Jib luffing Device

The jib luffing drum is equipped with the ratchet pawl locking device, to ensure the parking safety of jib under non-working state.

NO.4 Jib luffing device

Outermost working layer rope speed	0~72m/min
Diameter of wire rope	20mm
Length of jib luffing wire rope	410m
Rated single line pull	8t

7) Swing Mechanism

- It adopts the three-row roller slewing ring and is driven by the large-displacement single motor reducer, with the slewing speed of 0-1.1r/min; it has the median free slipping function, with 360° rotation provided. When the handle is at middle position and there is no slewing speed, the brake is at the closed position and the slewing is at the locking state through the locking device. If the traveling or transportation is done with load, the upper rotary impact should be prevented.

8) Counterweight

- Carbody counterweight: 2; total weight: 30t (15t × 2)
- Rear counterweight: 6t counterweight block, with a total of 14; a counterweight tray of 16t, with a total of 100t.

9) Cab

- The full-enclosed and wide-vision cab having a smooth shape and the Sany unique style is adopted, with the tempered glass equipped at front and sides. The GE structural sheet material is adopted at the top, which is characterized by a good transparency, high strength and high wear resistance; the indoor noise is low (less than 85dB). Air-conditioning, control devices, instrumentation, fire alarms and closed circuit monitoring system are installed indoors, in accordance with the ergonomic design.
- The cab can pitching 25 degrees upwards, expanding the vision of driver's operation, improving the operational safety, with the transport width reduced due to its rotatable characteristics.

10) Control Operation

- The track traveling operation can be controlled through the handle or the traveling pedal, having the control automatically forward direction function. With the function of automatic change of the direction of steering, no matter the superstructure rotates to no matter the superstructure rotates to any direction, the forward direction refers to the operator's forward direction.
- The boom winch, jib winch, luffing and rotary actions can be controlled by switching the handle function;.
- There are all operation buttons and control switches as well as the air conditioning control panel on the left and right armrest box, to achieve the different control function.

11) Alarm Display

All alarm information, including the wind speed, water temperature, oil temperature, oil level, oil pressure, working hours time and engine rotation errors, can be shown on the display in the cab, while giving the audible and visual alarm.

UNDERCARRIAGE

1) Traveling Drive

Each track part has an independent travel drive device, The traveling motor drives the machine to achieve independent traveling and turning through drive wheel and planetary gear reducer if travelling motor.

2) Traveling Brake

The travelling brake is a normally closed, built-in brake with automatic compensation function. When the control pedal valve is pressed down, the brake will be released to achieve travelling operation.

3) Track Shoe

The track shoe is made of high-strength and high wear-resistance material, with its tension regulated by the hydraulic jacks after installation. The ideal tension can be achieved through adjusting the position of gaskets.

OPERATION DEVICES

1) Boom

- The main chord pipe is made of high-strength material. And the boom frame is of lattice the space truss structure with the constant cross section at middle of boom and with the variable cross-section at two ends.
- Factory standard sections include: Boom base 10m, transition insert 6m, boom head 1m, intermediate section 3m×1, intermediate section 6m×1 and intermediate section 12m×5.
- The boom length can be variable between the basic boom (20m) and longest length (86m), which is increased by 3m.
- The 2.0m boom extension can be installed not only on the boom head but also on the luffing jib head.

2) Fixed Jib

- The main chord pipe is made of high-strength material. And the boom frame is of lattice the space truss structure with the constant cross section at middle of boom and with the variable cross-section at two ends.
- Jib top 6.5m, jib base 6.5m, intermediate section 6m × 1 and 11.5 m × 2; the usable fixed jib length includes 13m, 19m, 24.5m, 30.5m, 36m and 42m and the fixed jib can be mounted on the boom of the length of 29~62m.

3) Luffing Jib

- The main chord pipe is made of high-strength material. And the boom frame is of lattice the space truss structure with the constant cross section at middle of boom and with the variable cross-section at two ends.
- Jib top 6m, jib base 6m, intermediate section 3m × 1, 6m×2 and 12m × 3; the usable fixed jib length includes 21m, 24m, 27m, 30m, 33m, 36m, 39m, 42m, 45m, 48m, 51m, 54m, 57m, 60m and 63m the luffing jib can be mounted on the boom of the length of 26~62m.

4) Hook Block

- 16t hook
- 50t hook
- 100t hook
- 160t hook
- 260t hook

SAFETY DEVICES

1) Load moment Indicator

- The SCC2600A-type load moment indicator is a overload protection system specially designed for the Sany SCC series boom crawler crane, with the performance structure parameters of all Sany series crawler cranes stored directly in it, such as load curve, boom weight, center of gravity and other geometric parameters. The moment calculation adopts the targeted optimized model with tailor-made advantage, integrating Sany's technology accumulated over years in the area of crawler crane. It ensures lifting safety, maximizes the utilization efficiency by avoiding technology disjunction and after-sale service difficulties caused by different manufacturers of the crane and LMI, so as to enhance quality of the whole machine.
- As an independent safety control system completely controlled by a computer, the load moment limiter can automatically detect the load weight, working radius and lifting boom angle, and compare them with the rated load capacity and actual load, rated working radius and rated boom angle. Under normal operating condition, it can intelligently judge and automatically cut off the crane moving towards danger direction, It is also equipped with black box to record the overloading information.
- Its main components include display, controller, angle sensor and force sensor.

2) Three-color Load Alarm Light

Its corresponding moment limiter display can show the load progress bar state, reflecting the safety status of lifting load.

3) Main and Auxiliary Hoisting Limiter

When the lifting hook is raised to the height limit, it can send produce the alarm message and while cut off the lifting action of hook.

4) Lowering Limiter of Main and Auxiliary Winch

When the wire rope releases to the last three loops, it can send produce the alarm message, so the electrical control system can automatically cut off the lowering action.

5) Switch between Assembly/Operation Mode

In assembly mode, over hoisting limiter, boom angle limiter and load moment indicator will be bypassed for the assembly of the crane. In operation mode, all safety limit devices will function.

6) Lifting Boom Limit Detection Device

Under different operating conditions, through the detection of the limit switch and the boom angle signal of force limiter system, the crane boom or jib can operate within the safety angle.

7) Lifting Boom Back-stop Device

- The boom adopts the cylinder back-stop structure, with the larger compression and amount, the greater back-stop force. The maximum output force of back-stop cylinder is 38t.
- There is a pair of mechanical back-stop device on the rear mast of luffing jib, to prevent the mast overturn roll backward and to tension the rear mast pendant bar.
- If the angle between jib and boom is too small, the cylinder back-stop device can prevent it overturn roll backward, with the maxim output force of back-stop cylinder of 50t.

8) Winch Brake

All winch brakes adopt the spring-loaded normally closed disc brakes, which are characterized by the larger braking force, free maintenance, safe and reliable operation and long service life.

9) Monitoring System

With the high-definition camera adopted, the operator in the cab can monitor the real-time states of luffing drum, lifting winch drum and vehicle rear through the monitor.

10) Self-diagnosis System

It can automatically give the fault alarm message, and check the work powered state of electrical circuit, to quickly eliminate the electrical fault.

11) Phraos

It is mounted on the top of boom, to give the boom altitude lighting, so the boom lowering at night is not needed.

12) Anemometer

It is installed at the top of boom, to measure the wind speed in real time, and to transfer the data to the monitor display in the cab.

13) Level Gauge

The bubble level gauge is adopted as the validation basis and the electrical level indicator is adopted to give the high-precision display in real time, showing the crane tilting angle and informing the crane safety working ground environment.

14) Hook Latch Device

There are baffle on the hook to prevent the wire rope fall off.

15) Operating Alarm

Before any operation, press the horn to give an alarm, informing the crane will start work operation done now and other staff to pay attention to danger.

16) Traveling or Swing Alarm Message

In traveling or slewing operation, the working alarm lamps flashes, accompanied by a buzzer sound.

17) Function Lock

If the operator leaves the seat or the function locking handle is not at the proper position, all other functional control handles will not be working so as to are invalid, thus effectively avoiding misuse.

18) Automatic Reverse Traveling

No matter what the relative position of superstructure and chassis is pulled forwarded, the vehicle will travel forward; if pulled backwards, the vehicle will travel backward.

19) Monitor Display

The high-precision true color display with that is the vehicle electrical man-machine dialogue display terminal can show the working state and real-time parameters of engine system, hydraulic system and electrical system.

SCC2600A

23	Operating Condition Combination
24	H Operating Condition
28	Fixed Jib Combination
38	Luffing Jib Combination
56	Shield Operating Condition Load Charts

OPERATING CONDITION COMBINATION

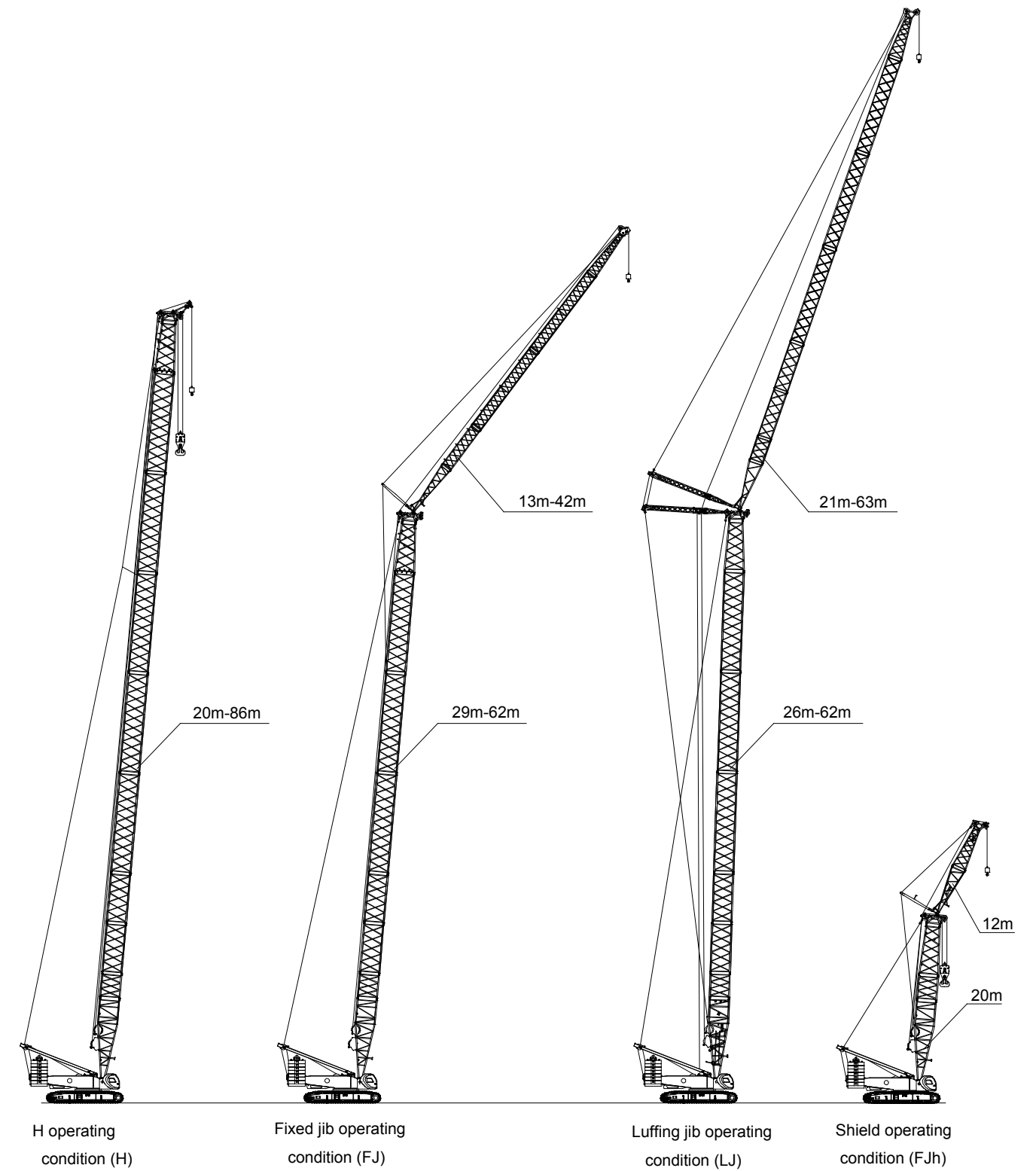

H OPERATING CONDITION

Boom length m	Insert		
	3 m	6 m	12m
20	1	-	-
23	-	1	-
26	1	1	-
29	-	-	-1
32	1	-	1
35	-	1	1
38	1	1	1
41	-	-	2
44	1	-	2
47	-	1	2
50	1	1	2
53	-	-	3
56	1	-	3
59	-	1	3
62	1	1	3
65	-	-	4
68	1	-	4
71	-	1	4
74	1	1	4
77	-	-	5
80	1	-	5
83	-	1	5
86	1	1	5

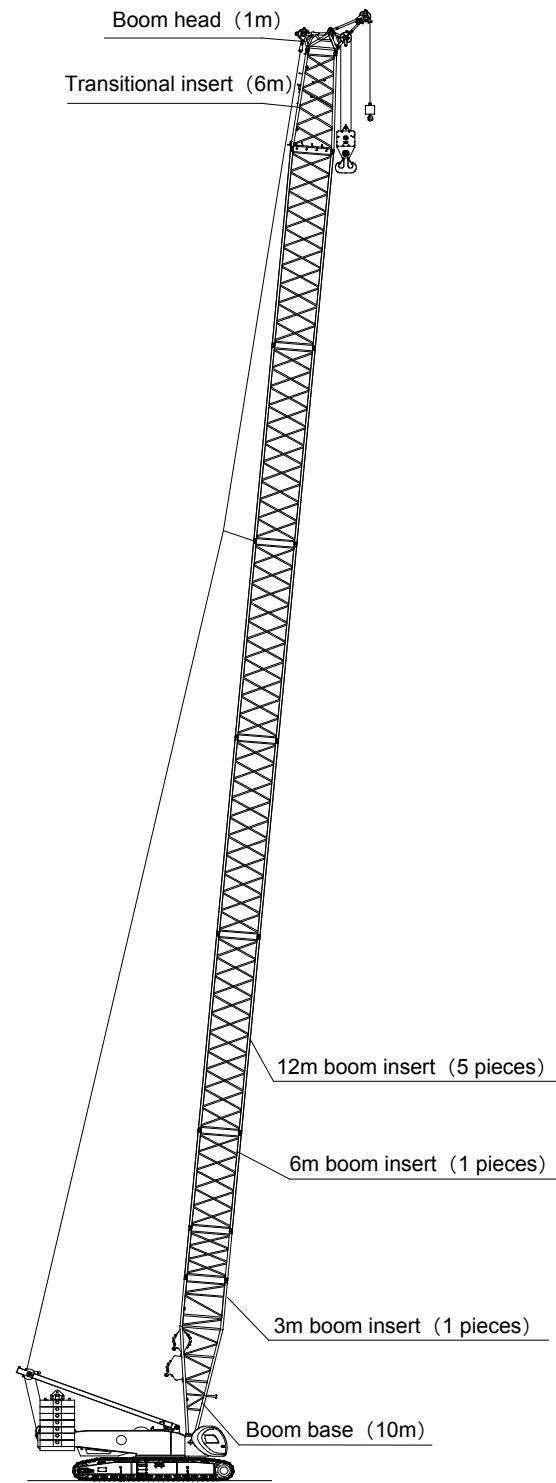

H OPERATING CONDITION

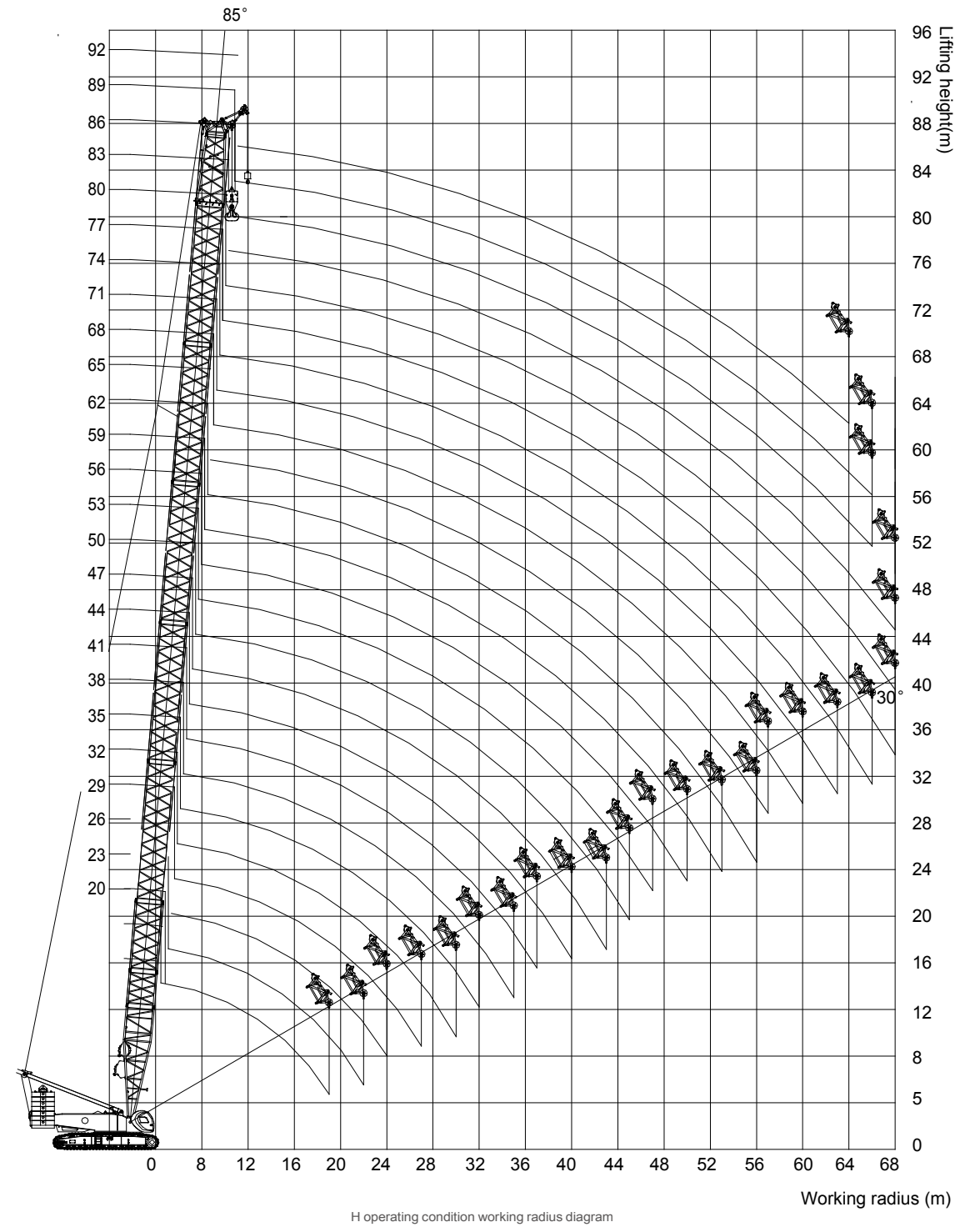

H OPERATING CONDITION LOAD CHARTS

SCC2600A Crawler Crane – H Operating Condition Load Charts

Boom length 20-86m		Rear counterweight 100t											Carbody counterweight 30t											Unit: (t)
Boom length (m)	Radius(m)	20	23	26	29	32	35	38	41	44	47	50	53	Boom length (m)	Radius(m)									
5		260.0													5									
6		238.4	224.9	223.6	204.2	194.0									6									
7		207.9	207.6	202.2	191.4	174.4	169.1	165.0	158.0						7									
8		183.8	178.3	174.4	170.6	166.3	157.9	156.5	141.8	126.3	125.0	124.0	122.0		8									
9		156.1	153.4	149.4	145.4	142.7	142.7	141.3	130.2	122.1	117.6	115.0	113.0		9									
10		141.2	137.8	135.7	132.2	130.1	129.2	128.0	125.8	115.5	115.5	107.1	104.9		10									
12		110.1	108.2	107.7	107.4	107.1	107.7	105.5	102.4	102.4	100.0	97.8	95.8		12									
14		89.6	88.8	88.1	87.7	87.2	87.2	86.9	86.8	85.8	84.2	82.4	80.9		14									
16		74.6	74.2	73.8	73.5	72.8	72.6	73.8	72.3	72.3	72.3	70.8	69.5		16									
18		63.8	63.3	62.8	62.5	62.5	62.6	62.0	62.3	61.6	61.5	61.7	60.7		18									
20		60.7	55.1	54.7	54.4	54.3	54.6	54.5	54.3	54.2	54.1	53.8	53.5		20									
22			49.5	48.8	48.3	48.2	48.2	48.1	48.0	47.8	47.7	47.5	47.6		22									
24				43.8	43.5	43.1	43.0	42.8	42.7	42.6	42.5	42.3	42.7		24									
26					39.1	39.0	39.1	38.9	38.9	38.0	38.3	38.2	38.1		26									
28					37.0	35.0	35.1	34.9	34.8	34.5	34.5	34.2	34.0		28									
30						31.4	31.6	31.4	31.3	31.1	31.0	30.7	30.5		30									
32							28.6	28.4	28.3	28.1	28.0	27.7	27.5		32									
34								25.8	25.7	25.5	25.4	25.1	24.9		34									
36								24.6	23.4	23.4	23.1	22.8	22.7		36									
38									22.3	21.7	22.0	20.8	20.6		38									
40										20.0	20.2	19.5	19.2		40									
42											17.8	17.7	17.6		42									
44												16.9	16.8	16.5	44									
46													16.5	15.2	46									

Notes: 1. The actual weight is a value that the rated weight in this table is subtracted by the weights of the hooks, hangers, and wire ropes winding on the hooks and on the boom head.
 2. The rated load in this table is measured under the condition that the heavy object is lifted slowly and stably from the level and hard soil ground.

H OPERATING CONDITION LOAD CHARTS

SCC2600A Crawler Crane – H Operating Condition Load Charts

Boom length 20-86m		Rear counterweight 100t											Carbody counterweight 30t											Unit: (t)
Boom length (m)	Radius(m)	56	59	62	65	68	71	74	77	80	83	86	Boom length (m)	Radius(m)										
8															8									
9		114.0	114.0	98.9	98.9										9									
10		92.0	90.0	90.0	90.0	89.0	83.3	83.3	83.3						10									
12		91.0	87.2	85.6	76.3	72.8	67.0	63.7	60.4	60.0	59.0	59.0			12									
14		79.1	77.7	74.9	73.1	71.8	65.1	60.3	54.9	51.8	51.2	50.0			14									
16		68.1	67.0	65.6	64.4	63.0	62.0	54.8	52.1	48.2	47.5	46.0			16									
18		59.4	58.5	57.3	56.2	55.1	54.2	53.0	47.4	45.5	44.9	39.0			18									
20		52.4	51.6	50.5	49.6	48.6	47.8	46.8	45.9	42.9	39.4	35.9			20									
22		46.6	45.9	44.9	44.1	43.2	42.5	41.5	40.8	39.8	36.6	32.1			22									
24		41.8	41.1	40.2	39.5	38.6	38.0	37.1	36.4	35.6	35.0	31.1			24									
26		37.6	37.1	36.2	35.6	34.7	34.2	33.4	32.7	31.9	31.4	28.7			26									
28		33.7	33.6	32.8	32.1	31.4	30.9	30.1	29.5	28.7	28.2	27.4			28									
30		30.2	30.1	29.8	29.2	28.4	28.0	27.2	26.6	25.9	25.4	24.7			30									
32		27.2	27.1	26.8	26.5	25.8	25.4	24.7	24.1	23.4	23.0	22.3			32									
34		24.6	24.5	24.2	24.0	23.5	23.1	22.4	21.9	21.2	20.8	20.1			34									
36		22.3	22.2	21.9	21.7	21.3	21.1	20.4	19.9	19.2	18.8	18.2			36									
38		20.3	20.2	19.8	19.6	19.3	19.1	18.6	18.1	17.4	17.1	16.4			38									
40		19.0	18.4	18.2	17.8	17.4	17.3	16.9	16.5	15.8	15.5	14.8			40									
42		17.5	17.1	16.9	16.3	16.0	15.7	15.3	15.0	14.3	14.0	13.4			42									
44		16.2	15.9	15.5	14.9	14.7	14.5	13.8	13.6	13.0	12.7	12.1			44									
46		15.0	14.5	14.0	13.7	13.4	13.2	12.5	12.3	11.8	11.5	10.8			46									
48		13.4	13.5	13.1	12.6	12.5	12.3	11.3	11.1	10.6	10.3	9.7			48									
50		12.5	12.5	12.0	11.7	11.5	11.2	10.2	9.9	9.6	9.3	8.7			50									
52			11.5	11.0	10.5	10.3	10.0	9.2	8.9	8.5	8.3	7.7			52									
54				10.2	10.0	9.5	8.6	8.2	8.0	7.6	7.4	6.8			54									
56					9.0	8.8	8.7	7.3	7.1	6.7	6.6	6.0			56									
58						7.9	7.8	6.5	6.3	5.9	5.8	5.2			58									
60							7.0	7.0	5.8	5.5	5.1	5.0	4.5		60									
62								6.0	5.0	4.8	4.4	4.3	3.8		62									
64									5.4	4.4	4.1	3.8	3.6	3.1	64									
66										3.7	3.5	3.1	3.0	2.5	66									
68											2.9	2.5	2.4		68									

Notes: 1. The actual weight is a value that the rated weight in this table is subtracted by the weights of the hooks, hangers, and wire ropes winding on the hooks and on the boom head.
 2. The rated load in this table is measured under the condition that the heavy object is lifted slowly and stably from the level and hard soil ground.

FIXED JIB COMBINATION

Jib length (m)	Insert		Boom length (m)	Angle between boom and jib
	6 m	11.5 m		
13	-	-	29~62	10° , 30°
19	1	-	29~62	10° , 30°
24.5	-	1	29~62	10° , 30°
30.5	1	1	29~62	10° , 30°
36	-	2	29~62	10° , 30°
42	1	2	29~62	10° , 30°

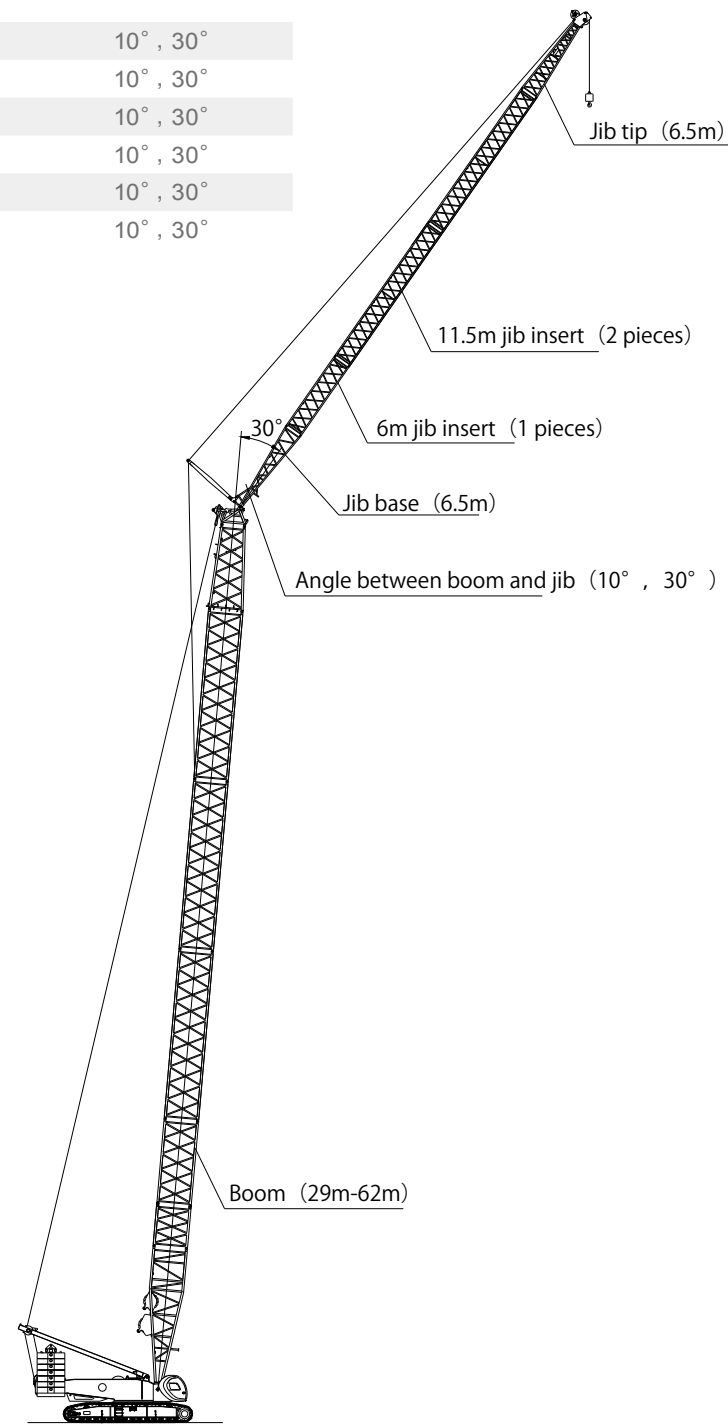

FIXED JIB WORKING RANGE DIAGRAM

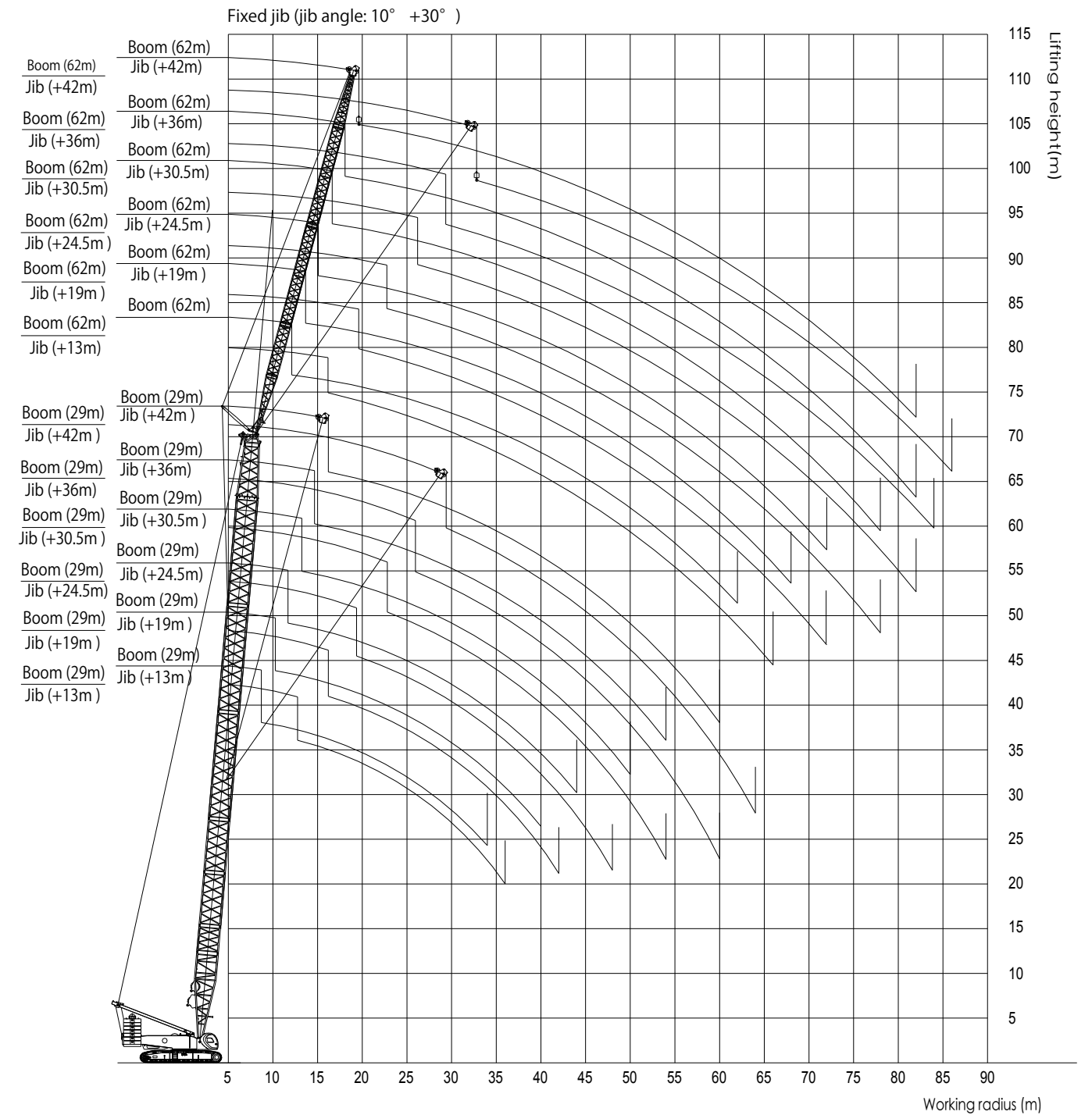

FIXED JIB LOAD CHARTS

SCC2600A Fixed Jib Load Charts (Without Jib Head Pulley Block)

Without main hook; jib angle: 10°

Unit: (t)

Boom length (m)							35							Boom length (m)	
29							35								
Jib length (m)	13	19	24.5	30.5	36	42	13	19	24.5	30.5	36	42	Jib length (m)	Radius(m)	
9	64.1												9		
10	64.4						64.4						10		
12	59.3	52.9					62.7	54.2					12		
14	53.1	49.7	44.4	34.7			56.6	51.5	45.2				14		
16	47.9	44.7	38.9	31.9	24.5		51.4	47.3	41.6	32.8	24.1		16		
18	43.7	40.6	34.1	28.1	23.7	17.4	47.1	43.2	36.5	29.9	23.4	17.2	18		
20	40.1	37.2	30.4	25.0	21.8	16.8	42.5	39.8	32.6	26.8	22.7	16.7	20		
22	37.1	34.4	27.5	22.7	19.7	16.2	38.0	36.9	29.8	24.2	20.9	16.1	22		
24	34.1	31.8	24.9	20.5	17.9	15.7	33.8	34.0	26.9	22.1	19.0	15.6	24		
26	30.5	29.3	22.9	18.8	16.3	14.4	34.2	30.8	24.8	20.1	17.5	15.2	26		
28	29.2	26.9	20.9	17.3	15.1	13.2	30.6	27.6	23.0	18.7	16.1	14.0	28		
30	28.0	25.0	19.4	16.0	13.9	12.2	29.3	25.0	21.4	17.3	14.9	13.0	30		
32	26.9	23.0	18.1	14.9	12.8	11.3	26.6	22.7	19.9	16.1	14.0	11.9	32		
34	24.5	22.5	17.0	13.9	12.0	10.5	24.9	22.1	18.6	15.1	12.9	11.1	34		
36		21.8	16.7	13.1	11.8	9.8	23.3	21.4	17.4	14.2	12.1	10.4	36		
38		20.1	16.2	12.2	11.6	9.7	21.3	19.6	16.4	13.3	11.4	9.8	38		
40		18.5	15.8	11.5	11.1	9.1	19.5	18.1	15.5	12.6	10.7	9.2	40		
42			15.0	11.3	10.5	9.0		16.7	15.4	11.9	10.5	9.0	42		
44			14.3	10.7	9.9	8.5		15.4	14.5	11.3	10.2	8.5	44		
46				10.3	9.4	8.0			13.5	10.7	9.7	8.0	46		
48				9.8	8.9	7.7			12.6	10.2	9.1	7.6	48		
50				9.4	8.4	7.1			11.6	9.7	8.7	7.2	50		
52					8.0	6.8				9.3	8.4	6.8	52		
54					6.8	6.5				8.9	7.9	6.5	54		
56						6.1					7.5	6.2	56		
58						5.9					7.2	5.9	58		
60						5.5					7.0	5.6	60		
62												5.4	62		
64													5.1	64	

Notes: 1. The actual weight is a value that the rated weight in this table is subtracted by the weights of the hooks, hangers, and wire ropes winding on the hooks and on the boom head.
2. The rated load in this table is measured under the condition that the heavy object is lifted slowly and stably from the level and hard soil ground.

FIXED JIB LOAD CHARTS

SCC2600A Fixed Jib Load Charts (Without Jib Head Pulley Block)

Without main hook; jib angle: 10°

Unit: (t)

Boom length (m)							41							47							Boom length (m)								
29							35							41							47								
Jib length (m)	13	19	24.5	30.5	36	42	13	19	24.5	30.5	36	42	13	19	24.5	30.5	36	42	Jib length (m)	Radius(m)									
10																				10									
12																				12									
14																				14									
16																				16									
18																				18									
20																				20									
22																				22									
24																				24									
26																				26									
28																				28									
30																				30									
32																				32									
34																				34									
36																				36									
38																				38									
40																				40									
42																				42									
44																				44									
46																				46									
48																				48									
50																				50									
52																				52									
54																				54									
56																				56									
58																				58									
60																				60									
62																				62									
64																				64									
66																				66									
68																				68									
70																				70									
72																				72									
74																				74									

Notes: 1. The actual weight is a value that the rated weight in this table is subtracted by the weights of the hooks, hangers, and wire ropes winding on the hooks and on the boom head.
2. The rated load in this table is measured under the condition that the heavy object is lifted slowly and stably from the level and hard soil ground.

FIXED JIB LOAD CHARTS

SCC2600A Fixed Jib Load Charts (Without Jib Head Pulley Block)

Without main hook; jib angle: 10°

Unit: (t)

Jib length (m)	53						56						Jib length (m)
	13	19	24.5	30.5	36	42	13	19	24.5	30.5	36	42	
10													10
12	58.8						58.8						12
14	56.9	52.7					55.7	49.5					14
16	49.1	48.5	39.8				48.2	47.6	38.2				16
18	43.0	42.6	39.2	28.8	21.8		42.1	41.8	37.7	28.1			18
20	38.0	37.7	37.6	28.3	21.4	16.0	37.2	37.0	36.8	27.6	22.4	16.9	20
22	33.8	33.7	33.6	27.8	20.9	15.6	35.3	33.0	32.9	27.2	22.0	16.5	22
24	32.3	30.3	30.2	25.9	20.5	15.2	31.6	29.6	29.6	26.6	21.5	16.1	24
26	29.1	27.3	27.4	24.1	20.0	14.9	30.2	26.7	26.8	24.5	21.0	15.8	26
28	28.3	24.8	24.9	22.4	18.8	14.5	28.9	24.2	24.3	22.8	20.6	15.4	28
30	26.9	22.6	22.7	20.9	17.7	14.2	27.6	23.4	22.1	21.5	19.2	15.0	30
32	27.2	22.0	20.8	19.6	16.5	13.8	26.5	22.8	20.3	20.2	18.1	14.6	32
34	24.8	21.3	19.1	18.5	15.6	13.3	24.1	22.7	18.5	18.6	17.0	14.3	34
36	22.7	20.7	17.5	17.3	14.6	12.5	22	22.4	17.0	17.1	15.9	13.7	36
38	20.7	19.1	16.1	16.2	13.9	11.9	20.2	20.5	16.6	15.7	15.1	12.9	38
40	18.9	18.5	15.8	14.9	13.2	11.1	18.4	18.8	16.3	14.5	14.4	12.2	40
42	17.2	17.9	15.5	13.8	12.5	10.6	16.9	17.3	15.0	13.4	13.7	11.5	42
44	15.7	16.4	14.3	12.8	11.9	10.1	15.4	15.9	14.6	12.3	13.0	11.0	44
46	14.4	15	13.3	11.8	11.2	9.5	14	14.6	14.0	11.4	12.2	10.5	46
48	13.1	13.8	12.2	11.0	10.8	9.1	12.7	13.4	13.8	10.5	11.4	9.9	48
50	12	12.6	11.1	10.1	10.2	8.6	11.6	12.2	12.7	10.3	10.5	9.4	50
52	10.9	11.5	10.9	10.0	9.5	8.2	10.5	11.2	11.7	10.1	9.7	9.0	52
54	9.9	10.6	10.0	9.8	8.8	7.9	9.6	10.2	10.7	9.4	9.0	8.6	54
56		9.7	9.4	9.3	8.2	7.5	8.7	9.3	9.8	9.4	8.2	8.2	56
58		8.8	9.3	9.0	7.5	7.2		8.4	9	9.3	7.6	7.7	58
60			8.6	8.9	7.0	6.9		7.7	8.2	8.5	7.0	7.1	60
62			7.8	8.2	6.4	6.5			7.5	7.8	6.4	6.5	62
64			7.1	7.5	5.9	6.0			6.8	7.1	5.9	6.0	64
66				6.8	5.4	5.6			6.1	6.5	5.4	5.4	66
68				6.2	5.0	5.1				5.9	4.9	5.0	68
70					4.5	4.7				5.3	4.5	4.6	70
72					4.1	4.2					4.0	4.1	72
74					3.7	3.8					3.6	3.7	74
76						3.5					3.2	3.3	76
78							3.2					3.0	78
80												2.6	80

Notes: 1. The actual weight is a value that the rated weight in this table is subtracted by the weights of the hooks, hangers, and wire ropes winding on the hooks and on the boom head.
 2. The rated load in this table is measured under the condition that the heavy object is lifted slowly and stably from the level and hard soil ground.

FIXED JIB LOAD CHARTS

SCC2600A Fixed Jib Load Charts (Without Jib Head Pulley Block)

Without main hook; jib angle: 10°

Unit: (t)

Jib length (m)	59						62						Jib length (m)
	13	19	24.5	30.5	36	42	13	19	24.5	30.5	36	42	
10													10
12													12
14	54.7	46.5					53.6						14
16	47.3	46.0	36.5				46.4	43.5	35.0				16
18	41.4	41.1	36.1	27.3			40.5	40.3	34.7	26.6			18
20	36.5	36.4	35.6	26.9	20.7		35.8	35.6	34.2	26.3	20.3		20
22	34.7	32.5	32.4	26.5	20.3	15.3	36.0	31.8	31.7	25.8	20.0	15.2	22
24	31.0	29.1	29.1	26.0	19.9	15.0	32.3	28.5	28.5	25.4	19.6	14.9	24
26	30.7	26.3	26.3	25.2	19.5	14.6	30.7	25.7	25.8	25.0	19.3	14.6	26
28	29.9	23.8	23.9	23.6	19.1	14.3	30.8	24.8	23.3	23.3	18.9	14.2	28
30	28.6	23.0	21.8	21.8	18.5	14.0	27.9	23.9	21.2	21.2	18.5	14.0	30
32	26	22.9	19.9	19.9	17.3	13.8	25.3	23.8	19.4	19.4	17.7	13.7	32
34	23.7	22.1	18.2	18.2	16.3	13.4	23	23.3	17.7	17.8	16.7	13.4	34
36	21.6	21.9	16.7	16.7	15.5	13.1	20.9	21.3	17.3	16.3	15.8	13.1	36
38	19.7	20.1	16.3	15.4	14.6	12.4	19.1	19.4	16.8	14.9	14.9	12.7	38
40	18	18.4	15.9	14.2	13.9	11.7	17.4	17.8	16.3	13.7	13.8	11.9	40
42	16.5	16.9	14.6	13.1	13.1	11.2	15.9	16.3	14.9	12.6	12.8	11.4	42
44	15.1	15.5	13.4	12.0	12.2	10.5	14.5	14.9	13.8	11.6	11.7	10.7	44
46	13.8	14.2	12.4	11.1	11.2	10.0	13.2	13.6	12.9	11.4	10.8	10.3	46
48	12.6	13	11.4	10.9	10.4	9.5	12	12.4	12.8	11.1	10.0	9.8	48
50	11.4	11.9	11.1	10.6	9.5	9.2	10.9	11.3	11.8	10.6	9.2	9.2	50
52	10.4	10.9	10.7	10.4	9.4	9.3	9.9	10.3	10.8	10.1	8.4	8.5	52
54	9.4	10	10.4	9.9	8.6	8.7	9	9.4	9.8	10.1	7.7	7.8	54
56	8.5	9.1	9.5	9.7	8.0	8.0	8.1	8.5	9	9.2	7.1	7.1	56
58	7.7	8.3	8.7	8.9	7.4	7.4	7.3	7.7	8.1	8.4	6.5	6.5	58
60		7.5	7.9	8.2	6.7	6.8	6.5	6.9	7.4	7.6	5.9	6.0	60
62		6.7	7.2	7.4	6.2	6.2		6.2	6.7	6.9	5.4	5.5	62
64		6.1	6.5	6.8	5.6	5.7		5.5	6	6.2	4.9	5.0	64
66			5.9	6.1	5.1	5.2		4.9	5.3	5.6	4.4	4.5	66
68			5.3	5.5	4.6	4.7			4.7	5	4.0	4.1	68
70				4.9	4.2	4.2			4.2	4.4	3.5	3.6	70
72					4.4	3.8	3.8				3.9	3.2	72
74					3.9	3.4	3.4				3.4	2.8	74
76						3.0	3.0				2.9	2.4	76
78						2.6	2.6					2.0	78
80							2.3					1.7	80
82								2.0					82
84									1.7				84

Notes: 1. The actual weight is a value that the rated weight in this table is subtracted by the weights of the hooks, hangers, and wire ropes winding on the hooks and on the boom head.
 2. The rated load in this table is measured under the condition that the heavy object is lifted slowly and stably from the level and hard soil ground.

FIXED JIB LOAD CHARTS

SCC2600A Fixed Jib Load Charts (Without Jib Head Pulley Block)

Without main hook; jib angle: 30°

Unit: (t)

29							35								
Boom length (m)							Boom length (m)								
Jib length (m)	13	19	24.5	30.5	36	42	Jib length (m)	13	19	24.5	30.5	36	42	Jib length (m)	Radius(m)
12															12
14	27.8						28.4								14
16	26.2						26.9								16
18	24.7	20.6					25.5	21							18
20	23.4	19.4	17.5				24.3	19.9							20
22	22.3	18.4	16.5				23.2	19	16.8						22
24	21.3	17.5	15.7	13.9			22.3	18.1	16	14.1					24
26	20.5	16.7	14.9	13.2			21.4	17.3	15.3	13.5					26
28	19.7	16	14.2	12.6	11.8		20.7	16.7	14.7	12.9	12				28
30	19	15.3	13.6	12	11.2		20	16	14.1	12.3	11.5				30
32	18.4	14.8	13	11.5	10.7	10	19.4	15.5	13.5	11.8	11	10.3			32
34	17.9	14.3	12.5	11	10.3	9.5	18.8	14.9	13.1	11.4	10.5	9.8			34
36	17.5	13.8	12.1	10.5	9.8	9.1	18.3	14.5	12.6	10.9	10.1	9.4			36
38		13.4	11.7	10.2	9.4	8.7	17.9	14.1	12.3	10.6	9.8	9			38
40		13	11.3	9.8	9.1	8.4	17.6	13.7	11.9	10.2	9.4	8.7			40
42		12.7	11	9.5	8.7	8.1	17.3	13.3	11.5	9.9	9.1	8.4			42
44			10.7	9.2	8.4	7.8		13	11.2	9.6	8.8	8.1			44
46			10.5	8.9	8.2	7.5		12.8	10.9	9.3	8.5	7.8			46
48			10.2	8.6	7.9	7.2		10.7	9	8.2	7.6				48
50				8.4	7.7	6.9		10.5	8.8	8	7.3				50
52				8.2	7.4	6.6		10.3	8.6	7.8	7				52
54				8	7.2	6.4			8.4	7.6	6.8				54
56					7.1	6.2			8.2	7.4	6.5				56
58					6.9	5.9			8.1	7.2	6.3				58
60					6.8	5.7				7.1	6				60
62						5.5				6.9	5.9				62
64						5.3				6.8	5.7				64
66											5.5				66
68												5.4			68
70													5.2		70

Notes: 1. The actual weight is a value that the rated weight in this table is subtracted by the weights of the hooks, hangers, and wire ropes winding on the hooks and on the boom head.
 2. The rated load in this table is measured under the condition that the heavy object is lifted slowly and stably from the level and hard soil ground.

FIXED JIB LOAD CHARTS

SCC2600A Fixed Jib Load Charts (Without Boom Hook and Counterweight 100+30t)

Without main hook; jib angle: 30°

Unit: (t)

41							47								
Boom length (m)							Boom length (m)								
Jib length (m)	13	19	24.5	30.5	36	42	Jib length (m)	13	19	24.5	30.5	36	42	Jib length (m)	Radius(m)
14															14
16	26.9						27.9								16
18	25.7	20.9					26.7								18
20	24.6	19.9					25.6	20.7							20
22	23.6	19	16.7				24.7	19.8	17.4						22
24	22.7	18.2	16				23.8	19.1	16.7						24
26	21.9	17.5	15.3	13.3			23	18.4	16	13.9					26
28	21.1	16.9	14.7	12.8	11.8		22.2	17.7	15.4	13.3					28
30	20.4	16.3	14.2	12.3	11.4		21.6	17.1	14.9	12.8	11.8				30
32	19.8	15.7	13.7	11.8	10.9	10	20.9	16.6	14.4	12.4	11.4	10.4			32
34	19.3	15.2	13.2	11.4	10.5	9.6	20.4	16.1	13.9	12	11	10			34
36	18.8	14.8	12.8	11	10.1	9.3	19.9	15.6	13.5	11.6	10.6	9.7			36
38	18.3	14.3	12.4	10.5	9.8	8.9	19.4	15.2	13.1	11.2	10.3	9.4			38
40	17.9	14	12.1	10.1	9.4	8.6	18.9	14.8	12.7	10.9	9.9	9			40
42	17.6	13.6	11.7	9.6	9.1	8.3	18.5	14.4	12.4	10.6	9.6	8.7			42
44	17.3	13.3	11.4	9.2	8.8	8	16.9	14.1	12.1	10.3	9.3	8.5			44
46	15.8	13	11.1	8.9	8.6	7.8	15.5	13.8	11.8	10	9.1	8.2			46
48		12.8	10.9	8.5	8.3	7.5	14.2	13.5	11.5	9.7	8.8	8			48
50		12.5	10.6	8.3	8.1	7.3	12.9	13.3	11.3	9.5	8.6	7.7			50
52		12.3	10.4	8	7.9	7.1		12.8	11.1	9.3	8.4	7.5			52
54			10.2	7.8	7.7	6.9		11.7	10.8	9.1	8.2	7.3			54
56			10.1	7.7	7.5	6.7		10.7	10.6	8.9	8	7.1			56
58				7.5	7.3	6.5			10.5	8.7	7.8	6.9			58
60				7.4	7.1	6.3			9.8	8.5	7.6	6.8			60
62				7.3	7	6.1			8.9	8.4	7.5	6.5			62
64					6.9	5.9				8.2	7.3	6.3			64
66					6.7	5.8				8.1	7.2	6.2			66
68					6.6	5.6				7.4	7	6			68
70						5.4					6.9	5.8			70
72						5.3					6.7	5.7			72
74							5.2					5.5			74
76												5.3			76
78													5.3		78

Notes: 1. The actual weight is a value that the rated weight in this table is subtracted by the weights of the hooks, hangers, and wire ropes winding on the hooks and on the boom head.
 2. The rated load in this table is measured under the condition that the heavy object is lifted slowly and stably from the level and hard soil ground.

unit: (t)

FIXED JIB LOAD CHARTS

SCC2600A Fixed Jib Load Charts (Without Boom Hook and Counterweight 100+30t)

Without main hook; jib angle: 30°

Unit: (t)

Radius(m)	53						56						Radius(m)					
	Jib length (m)						Jib length (m)											
13	19	24.5	30.5	36	42	13	19	24.5	30.5	36	42	13	19	24.5	30.5	36	42	
14						28.5						14						
16	28.3											16						
18		27.2										18						
20	26.2	21				26.4	21.1					20						
22	25.2	20.2				25.5	20.3					22						
24	24.4	19.4	16.9			24.6	19.6	17				24						
26	23.6	18.8	16.3	14		23.9	19	16.4				26						
28	22.9	18.2	15.7	13.5		23.2	18.3	15.9	13.6			28						
30	22.2	17.6	15.2	13.1	12	22.5	17.8	15.4	13.2	12.1		30						
32	21.6	17.1	14.7	12.6	11.6	21.9	17.3	14.9	12.7	11.7		32						
34	21	16.6	14.3	12.2	11.2	21.4	16.8	14.4	12.3	11.3	10.2	34						
36	20.5	16.1	13.9	11.8	10.8	20.8	16.3	14	12	10.9	9.9	36						
38	20	15.7	13.5	11.5	10.5	20.4	15.9	13.6	11.6	10.6	9.6	38						
40	19.6	15.3	13.1	11.2	10.2	19.5	15.5	13.3	11.3	10.3	9.3	40						
42	18	14.9	12.8	10.9	9.9	17.7	15.2	12.9	11	10	9	42						
44	16.4	14.6	12.4	10.6	9.6	16.1	14.8	12.6	10.7	9.7	8.7	44						
46	15	14.3	12.2	10.3	9.3	14.7	14.5	12.3	10.4	9.4	8.5	46						
48	13.7	14	11.9	10	9.1	13.4	14.2	12.1	10.2	9.2	8.3	48						
50	12.5	13.5	11.7	9.8	8.9	12.2	13.2	11.9	9.9	9	8	50						
52	11.4	12.3	11.4	9.6	8.6	11.1	12	11.6	9.7	8.8	7.8	52						
54	10.3	11.3	11.2	9.4	8.4	10	11	11.4	9.5	8.5	7.6	54						
56		10.3	11	9.2	8.2	9.1	10	10.8	9.3	8.4	7.4	56						
58		9.4	10.2	9	8	8.1	9.1	9.9	9.1	8.2	7.3	58						
60		8.5	9.3	8.8	7.9	7	8.2	9	8.9	8	7.1	60						
62			8.5	8.6	7.7	6.8	7.4	8.2	8.8	7.8	6.9	62						
64			7.7	8.4	7.6	6.6	6.6	7.4	8.1	7.7	6.8	64						
66			7	7.7	7.4	6.4		6.7	7.4	7.5	6.6	66						
68				7	7.3	6.2		6	6.7	7.3	6.3	68						
70					6.3	6.9	6		6	6.6	6.2	70						
72					5.7	6.3	5.9			5.4	6	72						
74						5.7	5.8			4.8	5.4	74						
76							5.1	5.6			4.8	76						
78								4.5	5			78						
80									4.5			80						
82											3.7	82						
84												84						
86												86						

Notes: 1. The actual weight is a value that the rated weight in this table is subtracted by the weights of the hooks, hangers, and wire ropes winding on the hooks and on the boom head.
 2. The rated load in this table is measured under the condition that the heavy object is lifted slowly and stably from the level and hard soil ground.

FIXED JIB LOAD CHARTS

SCC2600A Fixed Jib Load Charts (Without Boom Hook and Counterweight 100+30t)

Without main hook; jib angle: 30°

Unit: (t)

Radius(m)	59						62						Radius(m)					
	Jib length (m)						Jib length (m)											
13	19	24.5	30.5	36	42	13	19	24.5	30.5	36	42	13	19	24.5	30.5	36	42	
16												16						
18		27.6										18		27.7				
20		26.6	21.2									20		26.8				
22		25.7	20.5									22		25.9	20.6			
24		24.9	19.8	17.1								24		25.1	19.9	17.2		
26		24.1	19.1	16.5								26		24.4	19.3	16.7		
28		23.5	18.5	16	13.7							28		23.7	18.7	16.1	13.8	
30		22.8	18	15.5	13.3	12.1						30		23.1	18.2	15.6	13.4	
32		22.2	17.5	15	12.8	11.7						32		22.5	17.7	15.2	12.9	11.8
34		21.6	17	14.6	12.5	11.4	10.3					34		21.9	17.2	14.7	12.6	11.4
36		21.1	16.5	14.2	12.1	11	10					36		21.4	16.7	14.3	12.2	11.1
38		20.6	16.1	13.8	11.7	10.7	9.7					38		20.3	16.3	14	11.9	10.8
40		19.1	15.7	13.5	11.4	10.4	9.4					40		18.5	15.9	13.6	11.5	10.5
42		17.5	15.4	13.1	11.1	10.1	9.1					42		16.9	15.6	13.3	11.2	10.2
44		16	15	12.8	10.8	9.8	8.8					44		15.4	15.2	13	11	9.9
46		14.6	14.7	12.5	10.6	9.6	8.6					46		14.1	14.9	12.7	10.7	9.7
48		13.3	14.2	12.3	10.3	9.3	8.4					48		12.8	13.7	12.4	10.4	9.4
50		12.1	13	12	10.1	9.1	8.1					50		11.6	12.5	12.2	10.2	9.2
52		10.9	11.9	11.8	9.9	8.9	7.9					52		10.6	11.4	12	10	9
54		9.9	10.8	11.6	9.6	8.7	7.7					54		9.9	10.4	11.1	9.8	8.8
56		9	9.9	10.7	9.4	8.5	7.5					56		8.6	9.4	10.2	9.6	8.6
58		8.1	9	9.8	9.3	8.3	7.4					58		7.7	8.5	9.3	9.4	8.4
60		7.2	8.1	8.9	9.1	8.1	7.2					60		6.9	7.7	8.4	9	8.2
62			7.3	8.1	8.7	8	7					62		6.1	6.9	7.6	8.2	8.1
64				6.5	7.3	7.9	7.8					64			6.1	6.9	7.5	7.9
66				5.8	6.6	7.2	7.6					66			5.4	6.2	6.7	7.3
68					5.9	6.5	7					68			4.7	5.5	6.1	6.6
70						5.3	5.8					70				4.8	5.4	6
72							5.2					72				4.2	4.8	5.3
74								4.6				74				3.6	4.2	4.7
76									4			76					3.6	4.2
78										4		78					3.1	3.6
80											3.5	80						3.1
82												82						2.6
84												84						2.1
86												86						2.1
88												88						1.6

Notes: 1. The actual weight is a value that the rated weight in this table is subtracted by the weights of the hooks, hangers, and wire ropes winding on the hooks and on the boom head.
 2. The rated load in this table is measured under the condition that the heavy object is lifted slowly and stably from the level and hard soil ground.

LUFFING JIB COMBINATION

Jib length (m)	Insert			Boom length (m)	Angle between boom and jib
	3m	6m	12m		
21	1	1	—	26~62	65°~88°
24	—	2	—	26~62	65°~88°
27	1	1	—	26~62	65°~88°
30	—	1	1	26~62	65°~88°
33	1	1	1	26~62	65°~88°
36	—	2	1	26~62	65°~88°
39	1	2	1	26~62	65°~88°
42	—	2	2	26~62	65°~88°
45	1	1	2	26~62	65°~88°
48	—	2	2	26~62	65°~88°
51	1	2	2	26~62	65°~88°
54	—	1	3	26~62	65°~88°
57	1	1	3	26~62	65°~88°
60	—	2	3	26~62	65°~88°
63	1	2	3	26~62	65°~88°

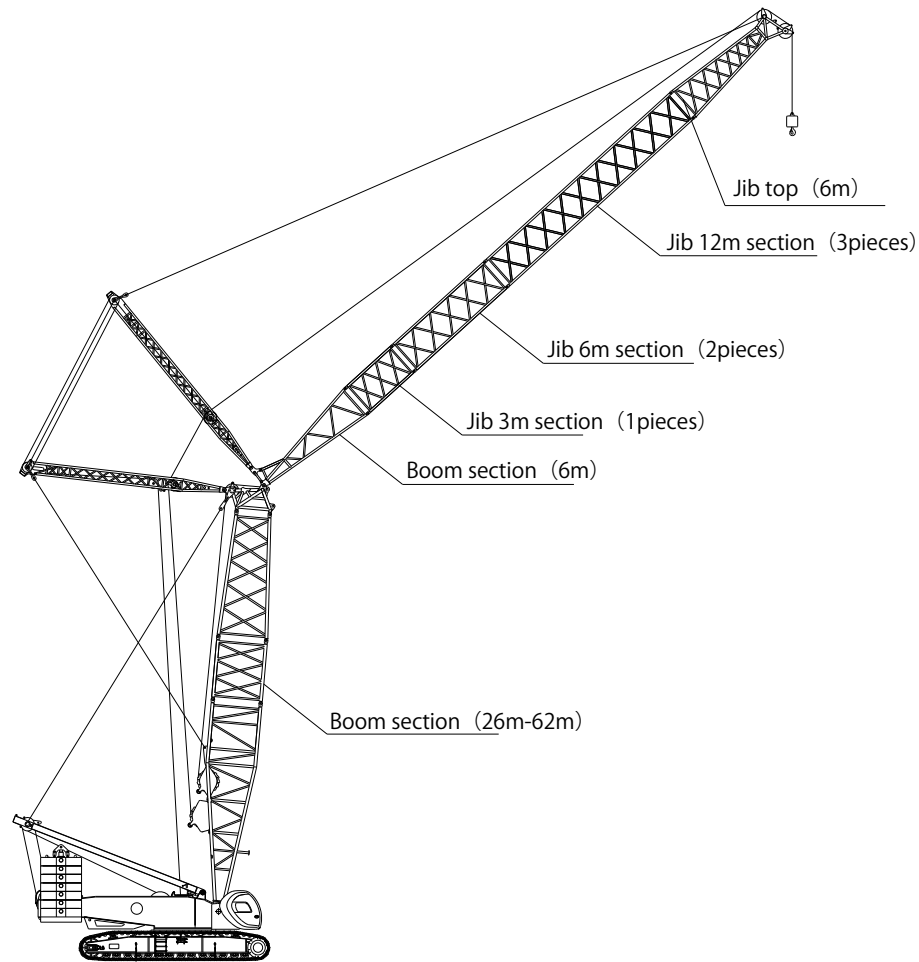

LUFFING JIB OPERATING CONDITION WORKING RANGE DIAGRAM

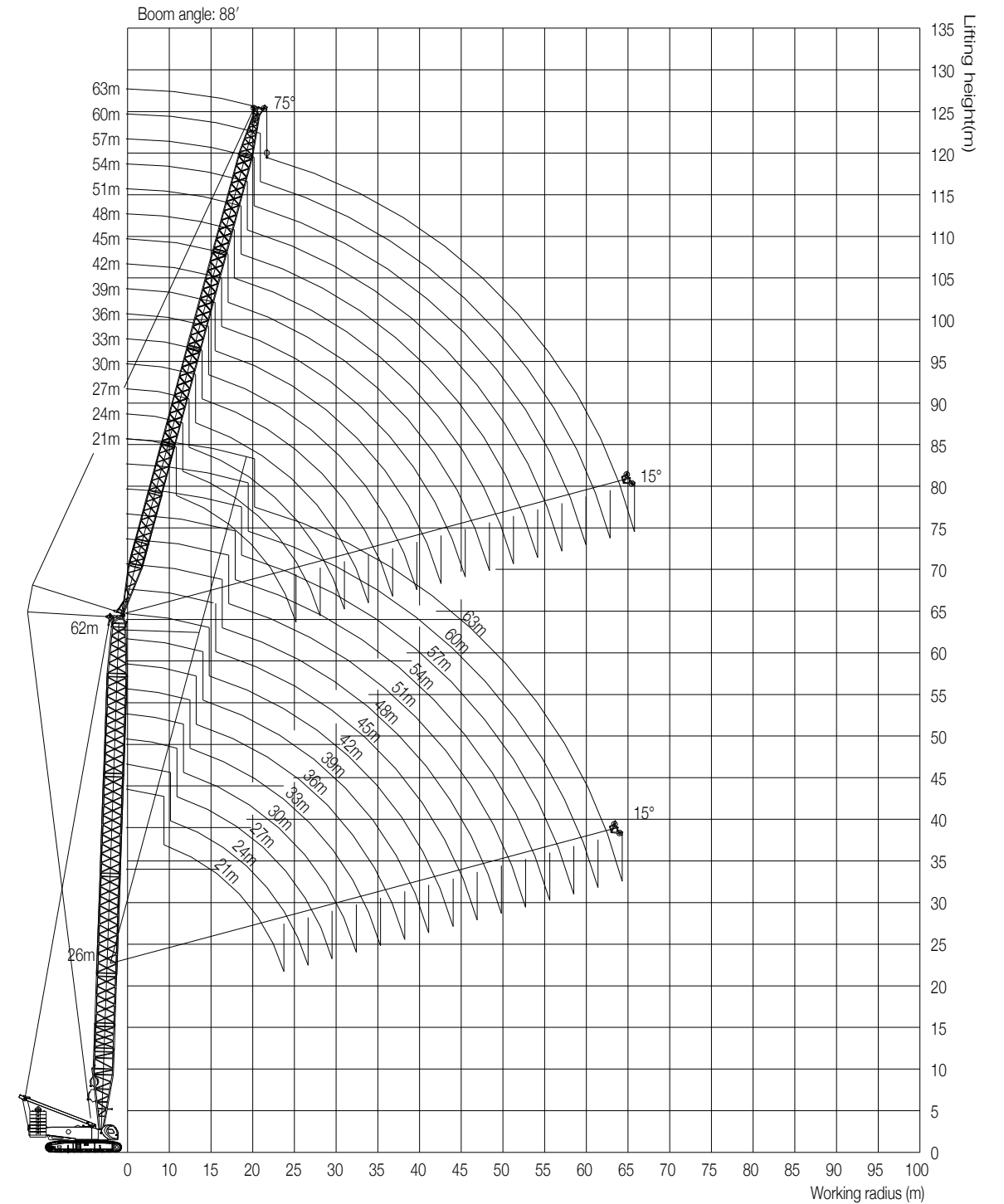

LUFFING JIB LOAD CHARTS

SCC2600A Luffing Jib Load Charts (Without Jib Head Pulley Block)

Unit: (t)

Boom length (m)	26																				
	21		24		27		30		33												
Jib length (m)	88	85	80	75	70	65	60	55	50	45											
Boom angle(°)	88	85	80	75	70	65	60	55	50	45											
Radius(m)	10	12	14	16	18	20	22	24	26	28											
10	90																				
12	88	89.8																			
14	77	84.3	84.8																		
16	67	72.4	71.9	83.8																	
18	59	62.9	63.8	73.9	81.1																
20	50	54.7	55.4	64.3	70.9	63.6	69.8														
22	38	45.5	51.7	56.9	62.7	56.6	62.4	61.6													
24		34.2	46.3	44.9	43.5	37.0	43.1	46.2	44.7												
26			41.9	40.6	39.3		35.4	41.9	40.5	39.2											
28				37.0	35.9	34.7		38.1	36.9	35.7											
30					32.9	31.9		35.0	33.9	32.8											
32						29.4		31.2	30.2	29.2											
34							28.0	27.1													
36								25.1													
38									23.3												
40										22.0											
42											20.1										
44												44									
46													46								
48														48							
50															50						
52																52					
54																	54				
56																		56			
58																			58		
60																				60	
62																					62

Notes: 1. The actual weight is a value that the rated weight in this table is subtracted by the weights of the hooks, hangers, and wire ropes winding on the hooks and on the boom head.
 2. The rated load in this table is measured under the condition that the heavy object is lifted slowly and stably from the level and hard soil ground.

LUFFING JIB LOAD CHARTS

SCC2600A Luffing Jib Load Charts (Without Jib Head Pulley Block)

Unit: (t)

Boom length (m)	26																				
	33		36		39		42		45												
Jib length (m)	88	85	80	75	70	65	60	55	50	45											
Boom angle(°)	88	85	80	75	70	65	60	55	50	45											
Radius(m)	10	12	14	16	18	20	22	24	26	28											
10																					
12																					
14		72.7																			
16		63.2	68.6																		
18		55.8	61.1	70.2																	
20		50.3	55.0	62.9	61.9																
22		45.5	49.2	55.8	60.1	55.4	59.1														
24		41.7	44.5	50.0	54.1	49.4	53.3	48.3	52.4												
26			38.4	40.8	41.0	38.3															
28				33.3	37.6	37.7	35.2														
30					30.8	34.5	34.0	32.1													
32					26.8	30.9	31.4	29.6	28.5												
34					22.3	26.6	29.1	27.5	26.4												
36					26.0	25.7	24.8	24.3	18.4	22.0											
38					20.6	23.9	23.0	22.7	17.9	25.2											
40					22.3	21.6	21.3		23.6	22.2											
42						20.3	19.9		20.9	20.1											
44							18.7		18.9	18.1											
46								17.7	17.1												
48									16.1												
50										15.0											
52											13.9										
54												13.2									
56													56								
58														58							
60															60						
62																62					
64																	64				
66																		66			
68																					68

Notes: 1. The actual weight is a value that the rated weight in this table is subtracted by the weights of the hooks, hangers, and wire ropes winding on the hooks and on the boom head.
 2. The rated load in this table is measured under the condition that the heavy object is lifted slowly and stably from the level and hard soil ground.

LUFFING JIB LOAD CHARTS

SCC2600A Luffing Jib Load Charts (Without Jib Head Pulley Block)

Unit: (t)

Boom length (m)	26									
	45	48	51	54	57	60	63	65	68	70
Jib length (m)	88	85	80	75	70	65	60	55	50	45
Boom angle(°)	88	85	80	75	70	65	60	55	50	45
Radius(m)	10	12	14	16	18	20	22	24	26	28
10										
12										
14										
16	48.2									
18	47.7	42.8	38.4							
20	47.1	46.7	42.1	41.9	37.9					
22	43.7	45.9	41.6	41.3	37.4	37.2				
24	39.9	42.1	39.4	40.8	36.8	36.6	30.6	30.4		
26	36.6	38.8	37.3	38.2	36.0	36.1	30.2	30.1		
28	33.6	35.9	34.5	33.9	33.2	34.8	29.8	29.6		
30	31.3	33.4	32.0	31.6	31.1	32.9	29.3	29.3	28.5	
32	29.1	31.1	30.0	28.7	28.8	30.7	28.7	29.0	28.2	
34	27.2	28.9	27.9	26.8	27.1	28.7	26.9	28.3	27.1	25.9
36	24.7	26.9	25.9	24.9	25.4	26.8	25.2	26.6	25.5	24.4
38	22.0	25.1	24.2	23.2	23.0	23.4	24.9	24.0	23.0	22.1
40	19.4	22.1	22.6	21.7	21.5	20.6	23.3	22.4	21.5	20.6
42	15.6	19.6	21.2	20.3	20.2	18.6	18.5	21.0	20.2	19.3
44	13.0	15.4	19.9	19.1	18.9	17.6	16.4	18.6	19.7	18.9
46	10.4	12.8	17.4	18.0	17.8	16.5	15.2	14.7	18.6	17.8
48	14.3	16.9	16.7	15.6	10.0	12.2	17.6	16.8	16.0	15.3
50	16.0	15.8	14.7	9.7	16.6	15.8	15.1	14.5	9.5	11.5
52	15.1	15.0	13.9	15.7	15.0	14.3	13.7	9.5	13.1	14.8
54	14.1	13.1	12.4	14.2	13.6	13.0	10.7	14.0	13.3	12.7
56	12.9	12.2	11.6	12.9	12.2	11.6	13.2	12.6	12.0	11.9
58	12.5	12.0	11.3	12.5	12.0	11.3	11.3	12.0	11.3	11.3
60	11.3	10.8	10.3	11.3	10.8	10.3	10.6	11.3	10.6	10.6
62	10.6	10.1	9.5	10.6	10.1	9.5	9.5	10.1	9.5	9.5
64	10.6	10.1	9.5	10.6	10.1	9.5	9.5	10.1	9.5	9.5
66	10.6	10.1	9.5	10.6	10.1	9.5	9.5	10.1	9.5	9.5
68	10.6	10.1	9.5	10.6	10.1	9.5	9.5	10.1	9.5	9.5

Notes: 1. The actual weight is a value that the rated weight in this table is subtracted by the weights of the hooks, hangers, and wire ropes winding on the hooks and on the boom head.
 2. The rated load in this table is measured under the condition that the heavy object is lifted slowly and stably from the level and hard soil ground.

LUFFING JIB LOAD CHARTS

SCC2600A Luffing Jib Load Charts (Without Jib Head Pulley Block)

Unit: (t)

Boom length (m)	26									
	57	60	63	65	68	70	75	80	85	90
Jib length (m)	88	85	80	75	70	65	60	55	50	45
Boom angle(°)	88	85	80	75	70	65	60	55	50	45
Radius(m)	10	12	14	16	18	20	22	24	26	28
10										
12										
14										
16										
18										
20	31.0	28.2								
22	30.5	27.7	25.3							
24	30.1	29.9	27.3	27.2	24.9					
26	29.5	29.4	26.9	26.7	24.6	24.5				
28	29.1	29.0	26.6	26.5	24.1	24.0				
30	28.8	28.5	26.1	26.0	23.8	23.7				
32	28.3	28.3	25.7	25.7	23.3	23.3				
34	26.6	27.5	25.3	25.2	24.8	23.0	23.0	22.6		
36	24.9	25.7	24.7	24.6	24.8	22.6	22.6	22.2		
38	23.3	24.2	23.1	23.0	23.9	22.8	21.7	22.2	21.9	
40	21.9	22.9	21.9	20.8	21.8	22.5	21.4	20.4	20.0	
42	20.5	21.4	20.4	19.5	20.5	21.2	20.3	19.3	20.3	18.9
44	19.4	20.1	19.2	18.4	19.4	19.9	19.0	18.1	19.3	17.8
46	17.5	18.9	18.1	17.2	16.4	18.3	17.8	17.0	16.2	18.1
48	15.8	17.8	17.0	16.2	15.4	16.6	16.8	16.0	15.2	17.3
50	14.2	16.0	16.0	15.3	14.6	13.9	14.9	16.7	15.8	15.1
52	10.2	14.5	15.1	14.4	13.8	13.1	13.4	15.2	14.9	14.2
54	8.5	10.2	14.3	13.7	13.0	12.3	12.1	13.8	14.1	13.5
56	6.8	8.6	13.6	13.0	12.2	11.6	7.7	9.4	13.4	12.8
58	6.8	12.9	12.2	11.6	11.0	6.3	7.9	12.7	12.1	11.4
60	12.2	11.6	11.0	10.4	9.9	6.4	8.8	11.4	10.8	10.3
62	11.6	11.0	10.4	9.9	9.4	7.5	10.9	10.3	9.7	4.5
64	10.4	9.9	9.4	8.9	8.4	5.8	10.3	9.7	9.2	4.5
66	9.4	8.9	8.4	8.9	8.4	9.7	9.2	8.7	8.7	5.4
68	8.4	8.4	8.4	8.4	8.4	8.7	8.3	8.7	8.3	9.1
70	8.4	8.4	8.4	8.4	8.4	8.7	8.3	8.7	8.3	8.6
72	8.4	8.4	8.4	8.4	8.4	8.7	8.3	8.7	8.3	8.6
74	8.4	8.4	8.4	8.4	8.4	8.7	8.3	8.7	8.3	8.6

Notes: 1. The actual weight is a value that the rated weight in this table is subtracted by the weights of the hooks, hangers, and wire ropes winding on the hooks and on the boom head.
 2. The rated load in this table is measured under the condition that the heavy object is lifted slowly and stably from the level and hard soil ground.

LUFFING JIB LOAD CHARTS

SCC2600A Luffing Jib Load Charts (Without Jib Head Pulley Block)

Unit: (t)

Jib length (m) Boom angle(°) Radius(m)	38														Jib length (m) Boom angle(°) Radius(m)							
	45							51								54						
	88	85	80	75	70	65	60	88	85	80	75	70	65	60		88	85	80	75	70	65	60
10																						
12																						
14																						
16	42.9																					
18	42.5																					
20	42.0																					
22	41.6	41.4																				
24	41.0	39.4																				
26	37.8	36.5																				
28	35.1	33.8	31.7																			
30	32.7	31.5	29.5																			
32	30.6	29.4	27.5																			
34	28.7	27.6	25.8	24.1																		
36	27.0	26.0	24.3	22.6																		
38	25.6	24.5	22.9	21.3																		
40	24.0	23.2	21.6	20.1																		
42	22.4	21.8	20.4	19.0	17.6																	
44	20.3	20.5	19.3	17.9	16.7																	
46	18.0	19.4	18.1	16.9	15.7																	
48	18.2	17.1	15.9	14.8	13.7	12.2																
50	16.1	15.0	14.0	12.9	11.8	10.9																
52	15.2	14.2	13.1	12.2	11.5	10.7																
54	13.4	12.5	11.5	10.5	9.5	8.6																
56	11.8	10.9	10.1	9.2	8.4	7.7																
58	11.2	10.3	9.4	8.5	7.7	7.0																
60	9.7	9.0	8.2	7.4	6.6	6.0																
62																						
64																						
66																						
68																						
70																						

Notes: 1. The actual weight is a value that the rated weight in this table is subtracted by the weights of the hooks, hangers, and wire ropes winding on the hooks and on the boom head.
 2. The rated load in this table is measured under the condition that the heavy object is lifted slowly and stably from the level and hard soil ground.

LUFFING JIB LOAD CHARTS

SCC2600A Luffing Jib Load Charts (Without Jib Head Pulley Block)

Unit: (t)

Jib length (m) Boom angle(°) Radius(m)	38														Jib length (m) Boom angle(°) Radius(m)							
	57							63								65						
	88	85	80	75	70	65	60	88	85	80	75	70	65	60		88	85	80	75	70	65	60
18																						
20	28.4																					
22	28.1																					
24	27.7	27.5																				
26	27.4	27.2																				
28	27.1	26.8																				
30	26.7	26.6																				
32	26.4	26.3	25.5																			
34	26.1	25.8	24.0																			
36	25.3	24.3	22.6																			
38	23.9	22.9	21.2																			
40	22.5	21.6	20.0	18.5																		
42	21.3	20.4	18.9	17.5																		
44	20.3	19.4	17.9	16.5																		
46	19.2	18.4	16.9	15.6																		
48	18.3	17.5	16.1	14.8	13.6																	
50	17.3	16.6	15.3	14.0	12.9																	
52	16.1	15.7	14.6	13.3	12.2																	
54	14.8	14.9	13.8	12.7	11.6																	
56	13.4	14.0	13.1	12.0	11.0	10.0																
58	12.0	13.3	12.3	11.3	10.4	9.5																
60	12.3	11.7	10.7	9.8	8.9	8.1																
62																						
64																						
66																						
68																						
70																						
72																						
74																						
76																						
78																						

Notes: 1. The actual weight is a value that the rated weight in this table is subtracted by the weights of the hooks, hangers, and wire ropes winding on the hooks and on the boom head.
 2. The rated load in this table is measured under the condition that the heavy object is lifted slowly and stably from the level and hard soil ground.

LUFFING JIB LOAD CHARTS

SCC2600A Luffing Jib Load Charts (Without Jib Head Pulley Block)

Unit: (t)

Boom length (m)	50																	
	21			24			27			30			33					
	88	85	80	75	70	65	88	85	80	75	70	65	88	85	80	75	70	65
Jib length (m)	71.5			65.3														
Jib length (m)	69.3			63.8			58.6											
Jib length (m)	61.4			59.2			57.4											
Jib length (m)	55.0			53.1			52.4											
Jib length (m)	49.9			48.2			47.4											
Jib length (m)	45.5			44.0			43.4											
Jib length (m)	41.9			41.1			40.4			39.9			39.4			38.8		
Jib length (m)	38.4			37.8			37.1			36.6			36.1			35.6		
Jib length (m)	35.6			34.9			34.3			33.8			33.3			32.8		
Jib length (m)	30.2			29.7			29.1			28.6			28.1			27.6		
Jib length (m)	28.2			27.7			27.1			26.6			26.1			25.6		
Jib length (m)	26.4			25.9			25.3			24.8			24.3			23.8		
Jib length (m)	24.6			24.1			23.6			23.1			22.6			22.1		
Jib length (m)	22.6			22.1			21.6			21.1			20.6			20.1		
Jib length (m)	20.2			19.6			19.1			18.6			18.1			17.6		
Jib length (m)	18.9			18.4			17.9			17.4			16.9			16.4		
Jib length (m)	17.7			17.2			16.7			16.2			15.7			15.2		
Jib length (m)	16.5			16.0			15.5			15.0			14.5			14.0		
Jib length (m)	15.4			14.9			14.4			13.9			13.4			12.9		
Jib length (m)	14.2			13.7			13.2			12.7			12.2			11.7		
Jib length (m)	13.4			12.9			12.4			11.9			11.4			10.9		
Jib length (m)	12.6			12.1			11.6			11.1			10.6			10.1		
Jib length (m)	11.8			11.3			10.8			10.3			9.8			9.3		
Jib length (m)	11.0			10.5			10.0			9.5			9.0			8.5		
Jib length (m)	10.2			9.7			9.2			8.7			8.2			7.7		
Jib length (m)	9.9			9.4			8.9			8.4			7.9			7.4		
Jib length (m)	9.2			8.7			8.2			7.7			7.2			6.7		
Jib length (m)	8.7			8.2			7.7			7.2			6.7			6.2		
Jib length (m)	8.2			7.7			7.2			6.7			6.2			5.7		
Jib length (m)	7.7			7.2			6.7			6.2			5.7			5.2		
Jib length (m)	7.2			6.7			6.2			5.7			5.2			4.7		
Jib length (m)	6.7			6.2			5.7			5.2			4.7			4.2		
Jib length (m)	6.2			5.7			5.2			4.7			4.2			3.7		
Jib length (m)	5.7			5.2			4.7			4.2			3.7			3.2		
Jib length (m)	5.2			4.7			4.2			3.7			3.2			2.7		
Jib length (m)	4.7			4.2			3.7			3.2			2.7			2.2		
Jib length (m)	4.2			3.7			3.2			2.7			2.2			1.7		
Jib length (m)	3.7			3.2			2.7			2.2			1.7			1.2		
Jib length (m)	3.2			2.7			2.2			1.7			1.2			0.7		
Jib length (m)	2.7			2.2			1.7			1.2			0.7			0.2		

Notes: 1. The actual weight is a value that the rated weight in this table is subtracted by the weights of the hooks, hangers, and wire ropes winding on the boom and on the boom head.
2. The rated load in this table is measured under the condition that the heavy object is lifted slowly and stably from the level and hard soil ground.

LUFFING JIB LOAD CHARTS

SCC2600A Luffing Jib Load Charts (Without Jib Head Pulley Block)

Unit: (t)

Boom length (m)	50																	
	33			36			39			42			45					
	88	85	80	75	70	65	88	85	80	75	70	65	88	85	80	75	70	65
Jib length (m)	48.9			44.1			40.3											
Jib length (m)	48.2			43.6			39.9											
Jib length (m)	47.5			43.6			39.9											
Jib length (m)	46.8			43.6			39.9											
Jib length (m)	44.1			41.9			42.4			41.2			39.0			39.3		
Jib length (m)	41.2			39.2			40.6			38.5			38.5			37.4		
Jib length (m)	38.2			36.3			35.6			35.0			34.6			34.6		
Jib length (m)	35.6			33.7			32.2			31.6			31.2			30.8		
Jib length (m)	33.2			31.5			30.4			30.4			30.4			30.4		
Jib length (m)	31.1			29.5			28.4			28.4			28.4			28.4		
Jib length (m)	29.3			27.7			26.8			26.8			26.8			26.8		
Jib length (m)	27.9			26.2			25.2			25.2			25.2			25.2		
Jib length (m)	26.9			25.2			24.3			24.3			24.3			24.3		
Jib length (m)	24.8			23.4			22.5			22.5			22.5			22.5		
Jib length (m)	22.4			21.2			20.4			20.4			20.4			20.4		
Jib length (m)	20.3			18.9			18.2			18.2			18.2			18.2		
Jib length (m)	18.8			17.4			16.6			16.6			16.6			16.6		
Jib length (m)	17.3			16.0			15.3			15.3			15.3			15.3		
Jib length (m)	16.4			15.1			14.5			14.5			14.5			14.5		
Jib length (m)	14.7			13.6			13.0			13.0			13.0			13.0		
Jib length (m)	14.0			13.0			12.7			12.7			12.7			12.7		
Jib length (m)	13.1			12.3			12.0			12.0			12.0			12.0		
Jib length (m)	12.3			11.6			11.4			11.4			11.4			11.4		
Jib length (m)	11.6			11.0			10.8			10.8			10.8			10.8		
Jib length (m)	11.0			10.5			10.2			10.2			10.2			10.2		
Jib length (m)	10.5			10.0			9.9			9.9			9.9			9.9		
Jib length (m)	10.0			9.5			9.3			9.3			9.3			9.3		
Jib length (m)	9.5			9.0			8.8			8.8			8.8			8.8		
Jib length (m)	9.0			8.5			8.3			8.3			8.3			8.3		
Jib length (m)	8.5			8.0			7.9			7.9			7.9			7.9		
Jib length (m)	8.0			7.5			7.4			7.4			7.4			7.4		
Jib length (m)	7.5			7.0			6.9			6.9			6.9			6.9		
Jib length (m)	7.0			6.5			6.4			6.4			6.4			6.4		
Jib length (m)	6.5			6.0			5.9			5.9			5.9			5.9		
Jib length (m)	6.0			5.5			5.4			5.4			5.4			5.4		
Jib length (m)	5.5			5.0			4.9			4.9			4.9			4.9		
Jib length (m)	5.0			4.5			4.4			4.4			4.4			4.4		
Jib length (m)	4.5			4.0			3.9			3.9			3.9			3.9		
Jib length (m)	4.0			3.5			3.4			3.4			3.4			3.4		
Jib length (m)	3.5			3.0			2.9			2.9			2.9			2.9		
Jib length (m)	3.0			2.5			2.4			2.4			2.4			2.4		
Jib length (m)	2.5			2.0			1.9			1.9			1.9			1.9		
Jib length (m)	2.0			1.5			1.4			1.4			1.4			1.4		
Jib length (m)	1.5			1.0			0.9			0.9			0.9			0.9		
Jib length (m)	1.0			0.5			0.4			0.4			0.4			0.4		
Jib length (m)	0.5			0.0			0.0			0.0			0.0			0.0		

Notes: 1. The actual weight is a value that the rated weight in this table is subtracted by the weights of the hooks, hangers, and wire ropes winding on the boom and on the boom head.
2. The rated load in this table is measured under the condition that the heavy object is lifted slowly and stably from the level and hard soil ground.

LUFFING JIB LOAD CHARTS

SCC2600A Luffing Jib Load Charts (Without Jib Head Pulley Block)

Unit: (t)

Boom length (m)	50									
	45	48	51	54	57	60	63	65	68	70
Jib length (m)	88	85	80	75	70	65	60	55	50	45
Boom angle(°)	10	12	14	16	18	20	22	24	26	28
Radius(m)	30.5	30.2	29.9	29.6	29.3	29.0	28.8	28.4	28.2	27.1
	32.9	32.7	32.3	32.4	32.0	31.6	31.1	30.6	28.7	27.5
	35.6	35.6	35.3	35.6	34.9	33.9	33.3	31.5	29.4	27.5
	36.5	36.5	36.3	35.6	34.9	33.9	33.3	31.5	29.4	27.5
	38.5	38.5	38.3	37.6	36.9	35.9	35.3	33.5	31.4	29.4
	40.5	40.5	40.3	39.6	38.9	37.9	37.3	35.5	33.4	31.4
	42.5	42.5	42.3	41.6	40.9	39.9	39.3	37.5	35.4	33.4
	44.5	44.5	44.3	43.6	42.9	41.9	41.3	39.5	37.4	35.4
	46.5	46.5	46.3	45.6	44.9	43.9	43.3	41.5	39.4	37.4
	48.5	48.5	48.3	47.6	46.9	45.9	45.3	43.5	41.4	39.4
	50.5	50.5	50.3	49.6	48.9	47.9	47.3	45.5	43.4	41.4
	52.5	52.5	52.3	51.6	50.9	49.9	49.3	47.5	45.4	43.4
	54.5	54.5	54.3	53.6	52.9	51.9	51.3	49.5	47.4	45.4
	56.5	56.5	56.3	55.6	54.9	53.9	53.3	51.5	49.4	47.4
	58.5	58.5	58.3	57.6	56.9	55.9	55.3	53.5	51.4	49.4
	60.5	60.5	60.3	59.6	58.9	57.9	57.3	55.5	53.4	51.4
	62.5	62.5	62.3	61.6	60.9	59.9	59.3	57.5	55.4	53.4
	64.5	64.5	64.3	63.6	62.9	61.9	61.3	59.5	57.4	55.4
	66.5	66.5	66.3	65.6	64.9	63.9	63.3	61.5	59.4	57.4
	68.5	68.5	68.3	67.6	66.9	65.9	65.3	63.5	61.4	59.4
	70.5	70.5	70.3	69.6	68.9	67.9	67.3	65.5	63.4	61.4
	72.5	72.5	72.3	71.6	70.9	69.9	69.3	67.5	65.4	63.4
	74.5	74.5	74.3	73.6	72.9	71.9	71.3	69.5	67.4	65.4

Notes: 1. The actual weight is a value that the rated weight in this table is subtracted by the weights of the hooks, hangers, and wire ropes winding on the hooks and on the boom head.
 2. The rated load in this table is measured under the condition that the heavy object is lifted slowly and stably from the level and hard soil ground.

LUFFING JIB LOAD CHARTS

SCC2600A Luffing Jib Load Charts (Without Jib Head Pulley Block)

Unit: (t)

Boom length (m)	50									
	57	60	63	65	68	70	75	80	85	90
Jib length (m)	88	85	80	75	70	65	60	55	50	45
Boom angle(°)	20	22	24	26	28	30	32	34	36	38
Radius(m)	25.6	25.3	25.0	24.8	24.5	24.2	23.9	23.7	23.6	23.4
	25.6	25.3	25.0	24.8	24.5	24.2	23.9	23.7	23.6	23.4
	27.6	27.3	27.0	26.8	26.5	26.2	26.0	25.8	25.6	25.4
	29.6	29.3	29.0	28.8	28.5	28.2	28.0	27.8	27.6	27.4
	31.6	31.3	31.0	30.8	30.5	30.2	30.0	29.8	29.6	29.4
	33.6	33.3	33.0	32.8	32.5	32.2	32.0	31.8	31.6	31.4
	35.6	35.3	35.0	34.8	34.5	34.2	34.0	33.8	33.6	33.4
	37.6	37.3	37.0	36.8	36.5	36.2	36.0	35.8	35.6	35.4
	39.6	39.3	39.0	38.8	38.5	38.2	38.0	37.8	37.6	37.4
	41.6	41.3	41.0	40.8	40.5	40.2	40.0	39.8	39.6	39.4
	43.6	43.3	43.0	42.8	42.5	42.2	42.0	41.8	41.6	41.4
	45.6	45.3	45.0	44.8	44.5	44.2	44.0	43.8	43.6	43.4
	47.6	47.3	47.0	46.8	46.5	46.2	46.0	45.8	45.6	45.4
	49.6	49.3	49.0	48.8	48.5	48.2	48.0	47.8	47.6	47.4
	51.6	51.3	51.0	50.8	50.5	50.2	50.0	49.8	49.6	49.4
	53.6	53.3	53.0	52.8	52.5	52.2	52.0	51.8	51.6	51.4
	55.6	55.3	55.0	54.8	54.5	54.2	54.0	53.8	53.6	53.4
	57.6	57.3	57.0	56.8	56.5	56.2	56.0	55.8	55.6	55.4
	59.6	59.3	59.0	58.8	58.5	58.2	58.0	57.8	57.6	57.4
	61.6	61.3	61.0	60.8	60.5	60.2	60.0	59.8	59.6	59.4
	63.6	63.3	63.0	62.8	62.5	62.2	62.0	61.8	61.6	61.4
	65.6	65.3	65.0	64.8	64.5	64.2	64.0	63.8	63.6	63.4
	67.6	67.3	67.0	66.8	66.5	66.2	66.0	65.8	65.6	65.4
	69.6	69.3	69.0	68.8	68.5	68.2	68.0	67.8	67.6	67.4
	71.6	71.3	71.0	70.8	70.5	70.2	70.0	69.8	69.6	69.4
	73.6	73.3	73.0	72.8	72.5	72.2	72.0	71.8	71.6	71.4
	75.6	75.3	75.0	74.8	74.5	74.2	74.0	73.8	73.6	73.4
	77.6	77.3	77.0	76.8	76.5	76.2	76.0	75.8	75.6	75.4
	79.6	79.3	79.0	78.8	78.5	78.2	78.0	77.8	77.6	77.4
	81.6	81.3	81.0	80.8	80.5	80.2	80.0	79.8	79.6	79.4
	83.6	83.3	83.0	82.8	82.5	82.2	82.0	81.8	81.6	81.4
	85.6	85.3	85.0	84.8	84.5	84.2	84.0	83.8	83.6	83.4

Notes: 1. The actual weight is a value that the rated weight in this table is subtracted by the weights of the hooks, hangers, and wire ropes winding on the hooks and on the boom head.
 2. The rated load in this table is measured under the condition that the heavy object is lifted slowly and stably from the level and hard soil ground.

LUFFING JIB LOAD CHARTS

SCC2600A Luffing Jib Load Charts (Without Jib Head Pulley Block)

Unit: (t)

Boom length (m) Jib length (m) Boom angle(°) Radius(m)	62											
	21	24	27	30	33	36	39	42	45	48		
10												
12												
14	57.7											
16	55.2	53.9										
18	52.7	51.8	48.6									
20	50.3	50.6	49.8	53.4								
22	48.2	49.8	47.7	49.8	45.2	48.6						
24	45.2	46.0	45.7	45.2	43.5	44.4	41.3	43.7				
26	42.1	43.4	43.9	41.4	41.8	40.7	39.9	40.1				
28	41.9	38.9	34.5	41.0	38.2	33.8	40.2	37.4	38.4	37.0		
30	36.1	32.0	38.1	35.4	31.3	37.4	34.7	30.7	36.8	34.3	30.2	
32	33.8	29.7	33.0	29.2	31.0	27.3	34.8	32.3	28.5	34.3	31.9	28.2
34	27.7	27.1	27.7	27.1	31.0	27.3	32.7	30.2	26.6	32.1	29.9	26.3
36	26.0	25.3	25.6	24.8	28.4	24.9	24.2	30.2	28.0	24.6	32	
38	23.8	23.3	24.0	23.3	23.5	22.7	26.4	23.1	22.3	34		
40	22.4	21.9	22.7	21.9	22.1	21.3	25.0	21.8	21.0	36		
42	21.2	16.5	20.7	16.0	20.1	19.0	20.6	19.8	38			
44	15.5	15.1	19.6	15.1	19.0	14.7	19.5	18.7	40			
46	14.7	13.8	14.3	13.6	12.7	17.1	13.1	16.8	12.9	42		
48	13.1	12.4	12.9	12.0	11.4	12.4	11.5	16.0	12.2	44		
50	11.7	11.7	11.8	10.9	10.3	11.8	10.9	11.5	10.6	46		
52			10.8	9.8	9.8	11.0	10.0	11.0	10.0	48		
54				9.3	9.3	10.4	9.5	10.4	9.5	50		
56						9.0	8.6	9.0	8.6	52		
58										54		
60										56		
62										58		
64										60		
66										62		
68										64		
										66		
										68		

Notes: 1. The actual weight is a value that the rated weight in this table is subtracted by the weights of the hooks, hangers, and wire ropes winding on the hooks and on the boom head.
2. The rated load in this table is measured under the condition that the heavy object is lifted slowly and stably from the level and hard soil ground.

LUFFING JIB LOAD CHARTS

SCC2600A Luffing Jib Load Charts (Without Jib Head Pulley Block)

Unit: (t)

Boom length (m) Jib length (m) Boom angle(°) Radius(m)	62										
	33	36	39	42	45	48	51	54	57	60	
10											
12											
14	42.3										
16	41.2	38.7									
18	40.1	37.8	36.0								
20	39.0	36.9	35.3	32.9							
22	37.9	36.0	34.6	32.3	31.8	32.7					
24	36.7	35.0	33.8	32.4	31.1	32.2	31.8	32.7			
26	35.7	34.0	33.1	32.4	30.5	31.8	31.1	32.2	31.8	32.7	
28	33.7	31.3	32.3	32.4	30.5	31.8	30.5	31.8	30.5	31.8	
30	31.5	29.3	31.5	30.2	29.9	29.8	29.9	29.8	29.9	29.8	
32	29.6	27.5	30.4	28.2	29.3	27.8	28.2	26.0	22.7	32	
34	27.9	25.8	27.4	25.4	26.9	24.8	26.5	24.5	21.3	34	
36	26.2	24.4	25.9	23.9	25.4	23.4	25.0	23.0	20.1	36	
38	23.1	20.1	24.6	22.7	24.0	22.1	23.7	21.8	18.9	38	
40	19.0	18.2	21.5	18.6	22.8	21.0	22.4	20.6	17.8	40	
42	18.1	17.2	20.4	17.6	20.9	19.9	22.4	20.6	17.8	42	
44	17.2	16.3	20.4	16.8	20.9	19.9	22.4	20.6	17.8	44	
46	15.5	11.7	16.7	15.9	19.0	16.3	15.4	16.7	18.6	16.0	15.1
48	14.7	11.1	15.9	15.1	15.5	14.6	10.9	17.7	15.2	14.3	46
50	14.0	10.5	14.3	10.7	14.8	13.8	10.3	17.0	14.5	13.5	10.0
52	10.0	9.0	13.6	10.2	14.1	13.2	9.7	13.8	12.9	9.5	50
54	9.5	8.5	13.0	9.6	12.5	9.3	9.3	13.2	12.2	9.0	52
56	8.1	7.7	9.2	8.2	11.9	8.7	7.7	11.7	8.6	54	
58	7.7	7.3	8.7	7.7	11.4	8.3	7.2	11.1	8.1	7.0	56
60	7.3	6.9	8.3	7.3	7.9	6.8	6.8	10.6	7.7	6.6	58
62			7.3	6.9	7.6	6.5	6.5	7.3	6.2	6.0	60
64					6.6	6.1	6.1	6.9	5.9	6.2	62
66								5.8	5.5	6.6	64
68											66
											68
											4.9

Notes: 1. The actual weight is a value that the rated weight in this table is subtracted by the weights of the hooks, hangers, and wire ropes winding on the hooks and on the boom head.
2. The rated load in this table is measured under the condition that the heavy object is lifted slowly and stably from the level and hard soil ground.

LUFFING JIB LOAD CHARTS

SCC2600A Luffing Jib Load Charts (Without Jib Head Pulley Block)

Unit: (t)

Boom length (m) Jib length (m) Boom angle (°) Radius(m)	45				48				51				54			
	88	85	80	75	70	65	60	55	50	45	40	35	30	25	20	15
18	30.5															
20	30.1															
22	29.6															
24	29.2	29.9														
26	28.6	29.5														
28	28.2	29.2														
30	27.6	27.3														
32	27.1	25.6	22.1													
34	26.0	24.0	20.8													
36	24.5	22.6	19.5													
38	23.1	21.3	18.5													
40	22.0	20.2	17.4													
42	20.9	19.2	16.5	15.4												
44	16.5	18.2	15.6	14.6												
46	15.1	17.3	14.8	13.8												
48	16.5	14.0	13.1													
50	15.8	13.4	12.4	9.0												
52	12.8	11.8	8.6													
54	12.2	11.2	8.1													
56	11.7	10.7	7.7													
58	10.2	7.3	6.1													
60	9.7	6.9	5.8													
62	6.6	5.4														
64	6.2	5.1														
66	5.9	4.8														
68	4.5															
70	4.2															
72	4.0															
74																
76																
78																
80																

Notes: 1. The actual weight is a value that the rated weight in this table is subtracted by the weights of the hooks, hangers, and wire ropes winding on the hooks and on the boom head.
2. The rated load in this table is measured under the condition that the heavy object is lifted slowly and stably from the level and hard soil ground.

LUFFING JIB LOAD CHARTS

SCC2600A Luffing Jib Load Charts (Without Jib Head Pulley Block)

Unit: (t)

Boom length (m) Jib length (m) Boom angle (°) Radius(m)	57				60				63			
	88	85	80	75	70	65	60	55	50	45	40	35
20	22.4											
22	22.1											
24	21.9											
26	21.6	21.7										
28	21.3	21.5										
30	21.1	21.2										
32	20.9	21.1										
34	20.6	20.9										
36	20.3	20.6	17.8									
38	20.2	19.7	16.7									
40	19.9	18.6	15.8									
42	19.3	17.6	14.9									
44	18.3	16.7	14.0									
46	17.4	15.8	13.3	12.1								
48	16.6	15.0	12.6	11.4								
50	15.7	14.3	12.0	10.8								
52	14.6	13.6	11.3	10.2								
54	9.4	13.0	10.8	9.7								
56	8.6	12.4	10.3	9.1	6.3							
58	7.9	11.9	9.8	8.7	5.9							
60		11.3	9.3	8.2	5.5							
62		10.9	8.9	7.8	5.2							
64		8.5	7.4	4.9								
66		8.1	7.0	4.6	3.3							
68		7.7	6.6	4.3	3.0							
70		6.3	4.1	2.8								
72		6.0	3.8	2.5								
74		5.5	3.5	2.3								
76		5.2	3.3	2.1								
78		3.1	1.9									
80			1.7									
82			1.5									
84												

Notes: 1. The actual weight is a value that the rated weight in this table is subtracted by the weights of the hooks, hangers, and wire ropes winding on the hooks and on the boom head.
2. The rated load in this table is measured under the condition that the heavy object is lifted slowly and stably from the level and hard soil ground.

SHIELD OPERATING CONDITION LOAD CHARTS

SHIELD OPERATING CONDITION LOAD CHARTS

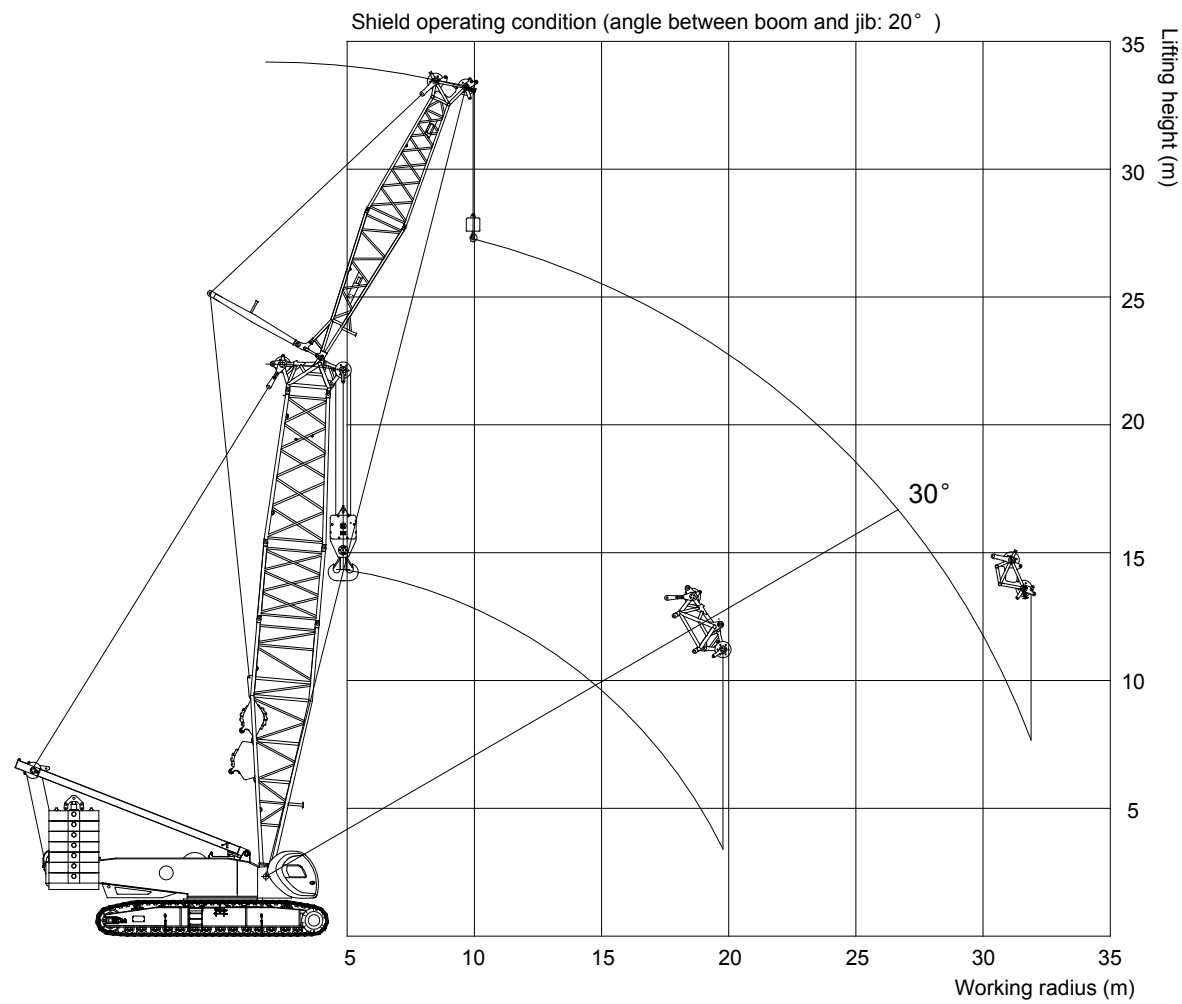

SCC2600A Crawler Crane Shield Operating Condition

Radius(m)	Boom 20m Jib 12m	
	Main hook load value (without load on the auxiliary hook)	Auxiliary hook load value (without load on the main hook)
5	249	
6	227	
7	190	
8	174	
9	150	
10	140	96
12	106	88
14	82	74
16	66	62.8
18	52.5	53.4
20	19/49	46.2
22		40.4
24		35.8
26		31.9
28		28.6
30		25.8

Notes: 1. The actual weight is a value that the rated weight in this table is subtracted by the weights of the hooks, hangers, and wire ropes winding on the hooks and on the boom head.
 2. The rated load in this table is measured under the condition that the heavy object is lifted slowly, stably from the level and hard soil ground .



Quality Changes the World

SANY HEAVY INDUSTRY CO., LTD.

Address: SANY Industrial Park, Economic and Technological
Development Zone, Changsha, Hunan, China

Service Hotline: +0086-4006-098-318

E-mail: crd@sany.com.cn

For more information, please visit: www.sanygroup.com

