



# SANY

Quality Changes the World



## **SANY CRAWLER CRANE SCC 900E**

# CRAWLER CRANE

## CONTENTS

### P3

#### SCC900E

Outline Dimensions  
Main Technical Features  
Main Performance Data  
Transport Dimensions

### P13

#### Specifications

Superstructure  
Undercarriage  
Operation Devices  
Safety Devices

### P21

#### Operating Conditions Combinations

Operating Condition Combination  
H Operating Condition  
Fixed Jib Operating Condition  
LJ Operating Condition

# SCC900E

03	Outline Dimensions
04	Main Technical Features
05	Main Performance Data
06	Transport Dimensions

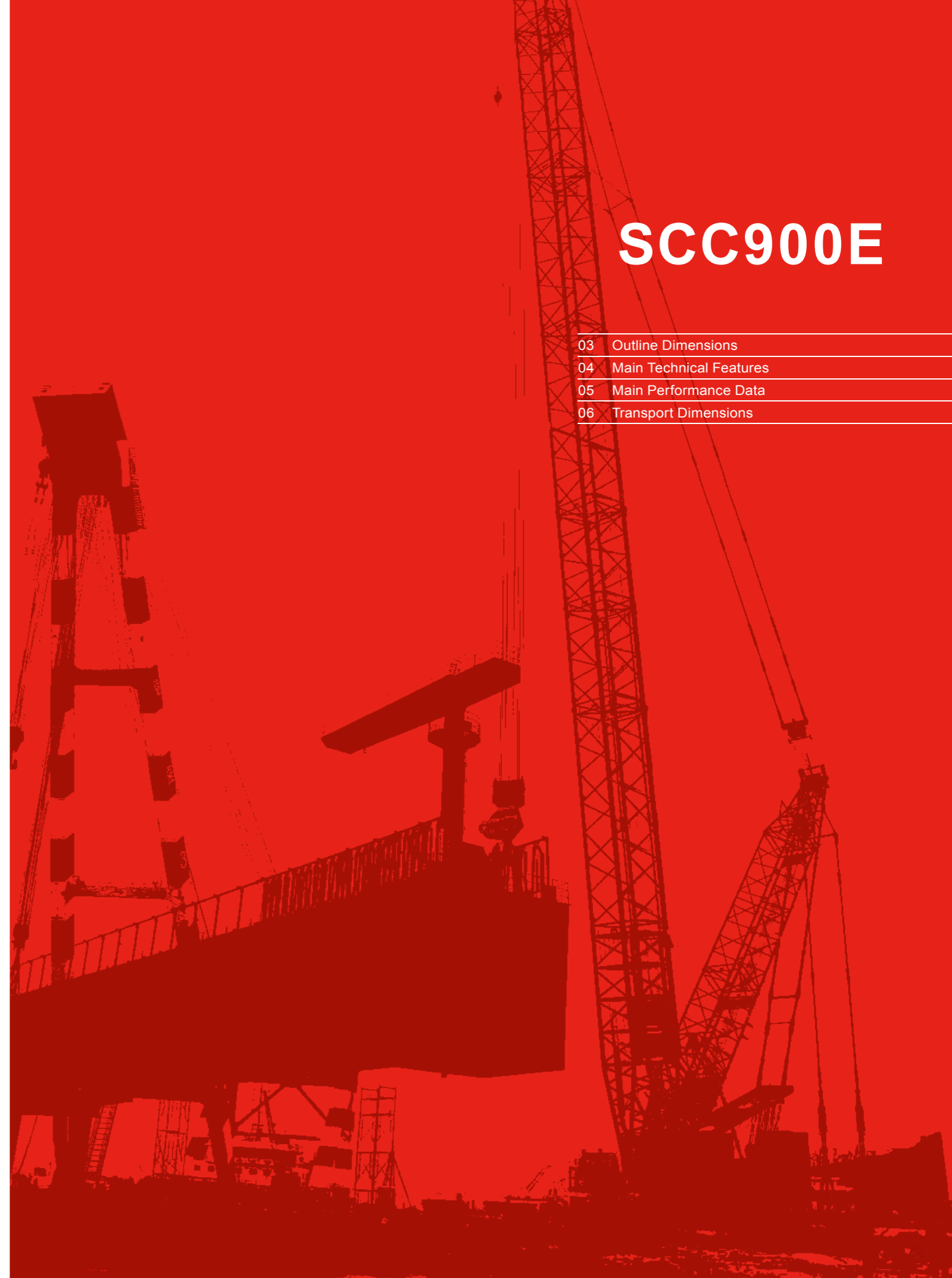
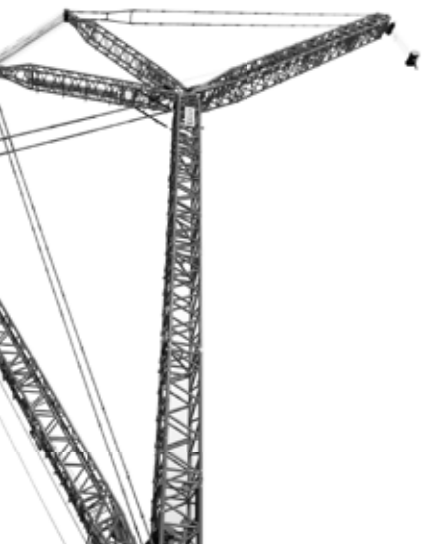

## OUTLINE DIMENSIONS

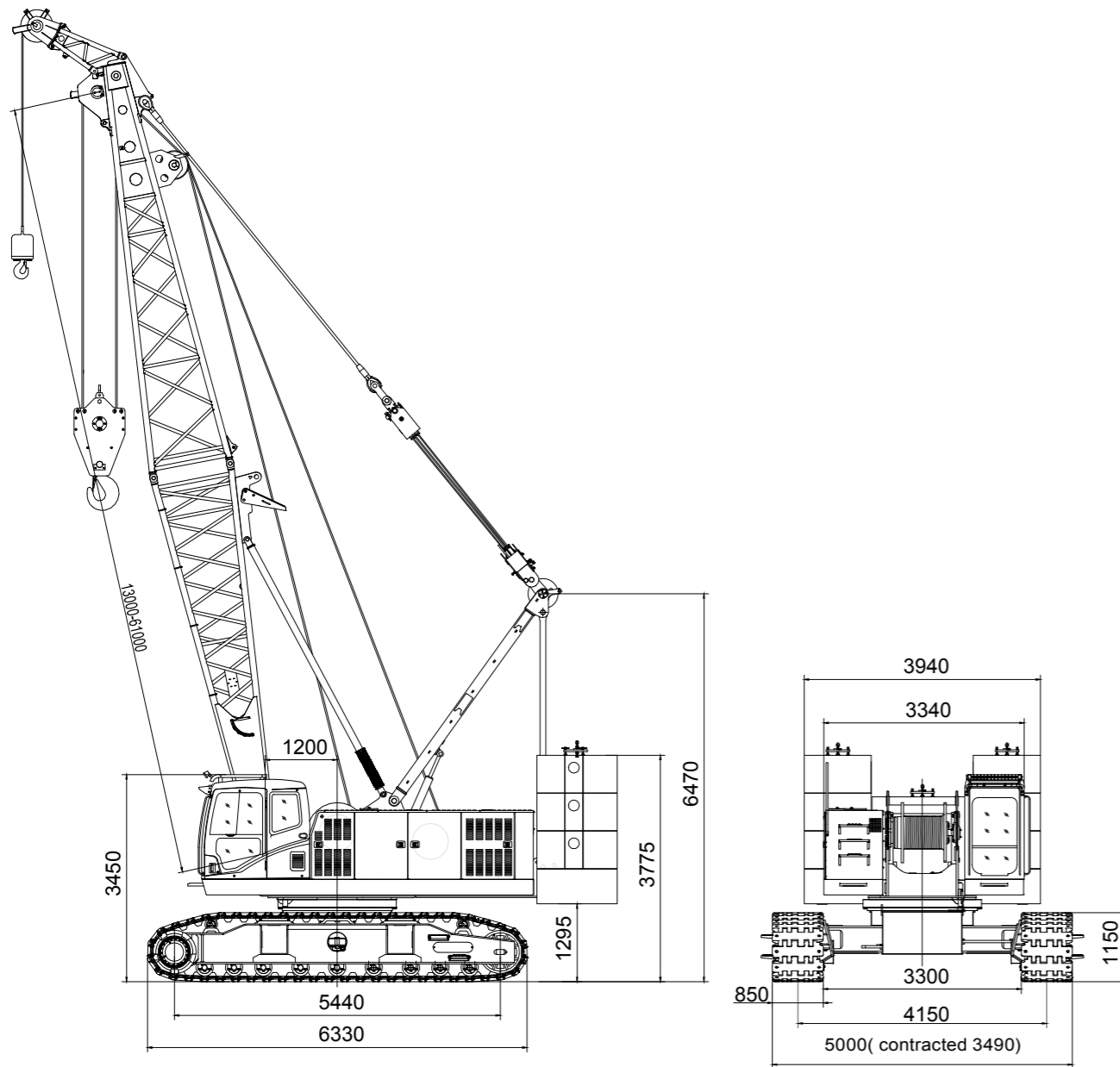

Basic Dimension of the Whole Machine of SCC900E Crawler Crane

## MAIN TECHNICAL FEATURES

### 1. Highly Secured Control System:

There are two operation modes, working and assembly for your convenience. It features with integrated control display system, emergency electrical control, and CCTV with a complete set of safety and monitoring devices.

### 2. Excellent Operating Performance:

Advanced micro-movement and compound actions ensure smooth and stable operation.

### 3. Reliable Function Assurance:

The safety margin in structural design is sufficient and the control system is fully capable to function stably in extreme weather. Advanced hydraulic technology is also adopted to ensure system stability and reliability;

### 4. Convenient Maintenance Access:

GPS remote monitoring system is adopted for maintenance and management. It takes no more than 10min/person to adjust, no more than 30 min/person for daily maintenance and no more than 2h/person to repair the machine.

### 5. Powerful Lifting Capacity:

The maximum lifting capacity of boom is  $90t \times 4m = 360t \cdot m$ , the maximum lifting capacity of fixed jib is  $8t \times 24m = 192t \cdot m$ , the lifting capacity of luffing jib is  $15t \times 14m = 210t \cdot m$  and the single pull line of main and auxiliary winches is 9.2t.

### 6. Optimized Transportation Programs:

With telescopic crawler, the maximum transportation weight of whole machine with track frame and boom tip is 43t, ensuring it to be transported around freely.

## MAIN PERFORMANCE DATA

Main Performance Data of SCC900E Crawler Crane			
Performance index		Unit	Data
Boom operating condition	Max. Rated Lifting Capacity	t	90
	Max. Lifting Torque	t·m	90×4
	Boom Length	m	13~61
	Boom Luffing Angle	°	30~80
Fixed Jib Operating Condition	Max. Rated Lifting Capacity	t	8
	Max. Lifting Torque	t·m	8×24
	Jib Length	m	9~18
	Max.Length Boom + Max. Length Jib	m	52+18
Luffing jib Operating Condition	Max. lifting capacity	t	18.4
	Max. lifting torque	t·m	15×14
	Longest boom + longest luffing jib	m	43.3+31
	Boom luffing angle	°	60~90
	Jib luffing angle	°	15~75
Operating Speed	Rope Speed of Main and Auxiliary Winches(4 <sup>th</sup> layer)	m/min	0~120
	Rope Speed of Luffing Winch(4 <sup>th</sup> layer)	m/min	0~58
	Swing Speed	rpm	0~3.2
	Traveling Speed	km/h	0~1.5
Engine	Engine Type		QSC8.3-C260-30
	Rated Power/Rate Speed	kW/ rpm	194/2000
Transportation Data	Basic Boom Weight	t	85
	Max. Transportation Weight of Single Piece(with track frame and boom base)	t	43
	Transportation Dimension(with track frame and boom base)Length×Width×Height	mm	13300×3490×3450
Other Data	Average Ground Pressure	MPa	0.085
	Gradeability	%	30

## TRANSPORT DIMENSIONS

<b>Basic machine(with track frame)</b>	<b>×1</b>
Length (L)	13.3m
Width(W)	3.49m
Height(H)	3.45m
Weight	43t
<b>Track Frame Assembly</b>	<b>×2</b>
Length (L)	6.33m
Width(W)	1.02m
Height(H)	1.15m
Weight	9.1t
<b>Counterweight Tray</b>	<b>×1</b>
Length (L)	3.94m
Width(W)	1.34m
Height(H)	0.74m
Weight	9.5t
<b>Left Counterweight</b>	<b>×3</b>
Length (L)	1.34m
Width(W)	1.12m
Height(H)	0.7m
Weight	2.7t
<b>Right Counterweight</b>	<b>×3</b>
Length (L)	1.34m
Width(W)	1.12m
Height(H)	0.70m
Weight	2.7t
<b>Central Counterweight</b>	<b>×2</b>
Length (L)	1.68m
Width(W)	0.72m
Height(H)	0.68m
Weight	2.2t

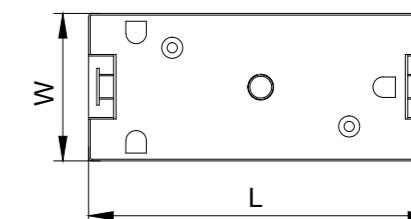
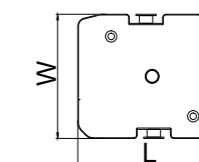
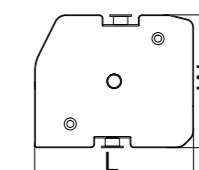
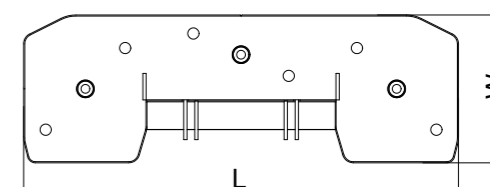
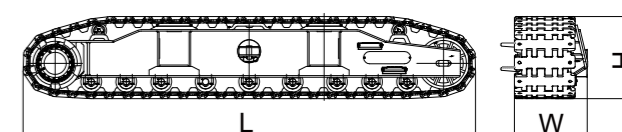
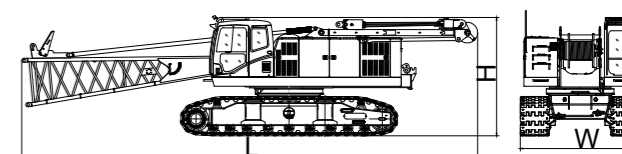

## TRANSPORT DIMENSIONS

<b>Undercarriage Counterweight</b>	<b>×2</b>
Length(L)	2.04m
Width(W)	1.35m
Height(H)	0.82m
Weight	5t
<b>Boom Base</b>	<b>×1</b>
Length(L)	6.72m
Width(W)	1.86m
Height(H)	2.15m
Weight	1.6t
<b>Boom tip</b>	<b>×1</b>
Length(L)	7.13m
Width(W)	1.61m
Height(H)	1.52m
Weight	1.6t
<b>3m Boom Insert</b>	<b>×2</b>
Length(L)	3.14m
Width(W)	1.68m
Height(H)	1.58m
Weight	0.4t
<b>6m Boom Insert</b>	<b>×1</b>
Length(L)	6.14m
Width(W)	1.68m
Height(H)	1.58m
Weight	0.65t
<b>9m Boom Insert</b>	<b>×4</b>
Length(L)	9.14m
Width(W)	1.68m
Height(H)	1.58m
Weight	0.9t
<b>Jib Tip</b>	<b>×1</b>
Length(L)	4.88m
Width(W)	0.87m
Height(H)	0.77m
Weight	0.35t

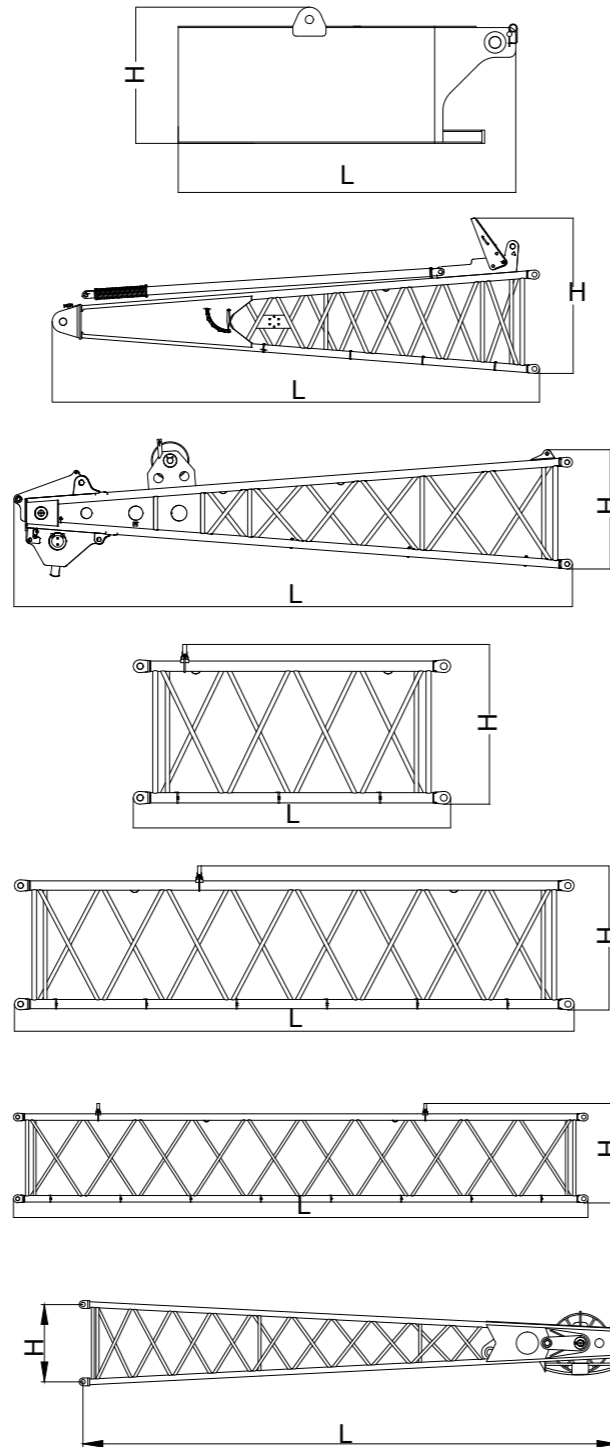

## TRANSPORT DIMENSIONS

<b>Jib Base</b>	<b>×1</b>
Length(L)	4.69m
Width(W)	0.89m
Height(H)	0.77m
Weight	0.3t
<b>4.5m Jib Insert</b>	<b>×2</b>
Length(L)	4.57m
Width(W)	0.86m
Height(H)	0.96m
Weight	0.2t
<b>Boom Extension</b>	<b>×1</b>
Length(L)	1.89m
Width(W)	0.74m
Height(H)	0.64m
Weight	0.17t
<b>100t Hook Block</b>	<b>×1</b>
Length(L)	2.1m
Width(W)	0.85m
Height(H)	0.61m
Weight	1.42t
<b>50t Hook Block</b>	<b>×1</b>
Length(L)	1.99m
Width(W)	0.85m
Height(H)	0.45m
Weight	0.97t

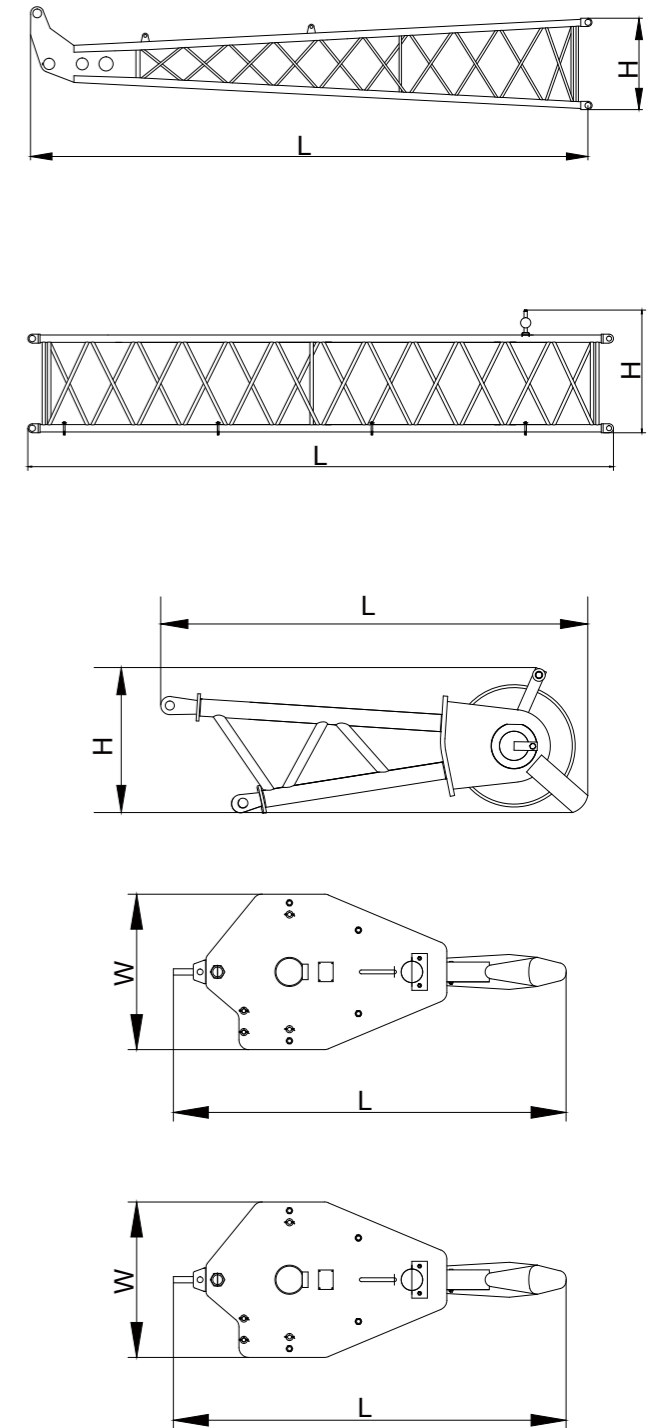

## TRANSPORT DIMENSIONS

<b>25t Hook Block</b>	<b>×1</b>
Length(L)	1.79m
Width(W)	0.85m
Height(H)	0.36m
Weight	0.55t
<b>9t Ball Hook</b>	<b>×1</b>
Length(L)	0.95m
Width(W)	0.36m
Height(H)	0.36m
Weight	0.35t

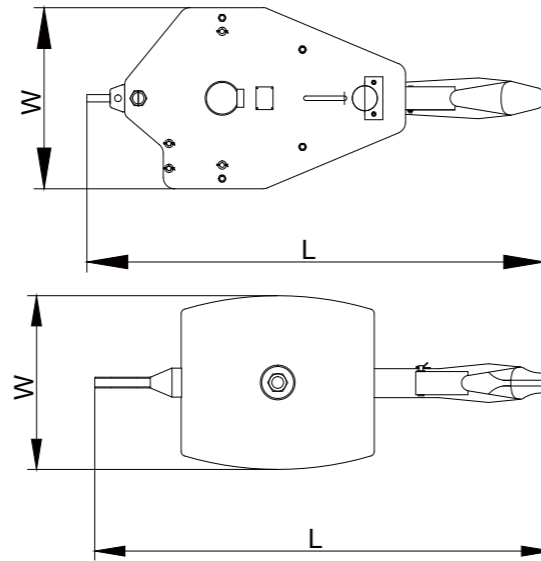

Note: 1.The transportation dimensions are not drawn to proportion. The dimensions in the sketch are design value excluding packages.  
2.The weight is design value and there may be tiny difference due to the manufacturing calibration and product upgrading. The actual weight is subjected to the latest products.

## TRANSPORT DIMENSIONS

<b>Boom Head Set of Luffing Jib</b>	<b>×1</b>
Length	3.47m
Width	1.43m
Height	1.63m
Weight	0.74t
<b>Mast Set of Luffing Jib</b>	<b>×1</b>
Length	4.958m
Width	1.446m
Height	0.795m
Weight	0.64t
<b>Boom Base of Luffing Jib</b>	<b>×1</b>
Length	5.48m
Width	1.35m
Height	0.97m
Weight	0.35t
<b>Boom Tip of Luffing Jib</b>	<b>×1</b>
Length	5.42m
Width	1.01m
Height	0.84m
Weight	0.40t
<b>3m Insert of Luffing Jib</b>	<b>×1</b>
Length	3.08m
Width	1.02m
Height	0.84m
Weight	0.13t
<b>6m Insert of Luffing Jib</b>	<b>×3</b>
Length	6.08m
Width	1.02m
Height	0.99m
Weight	0.24t

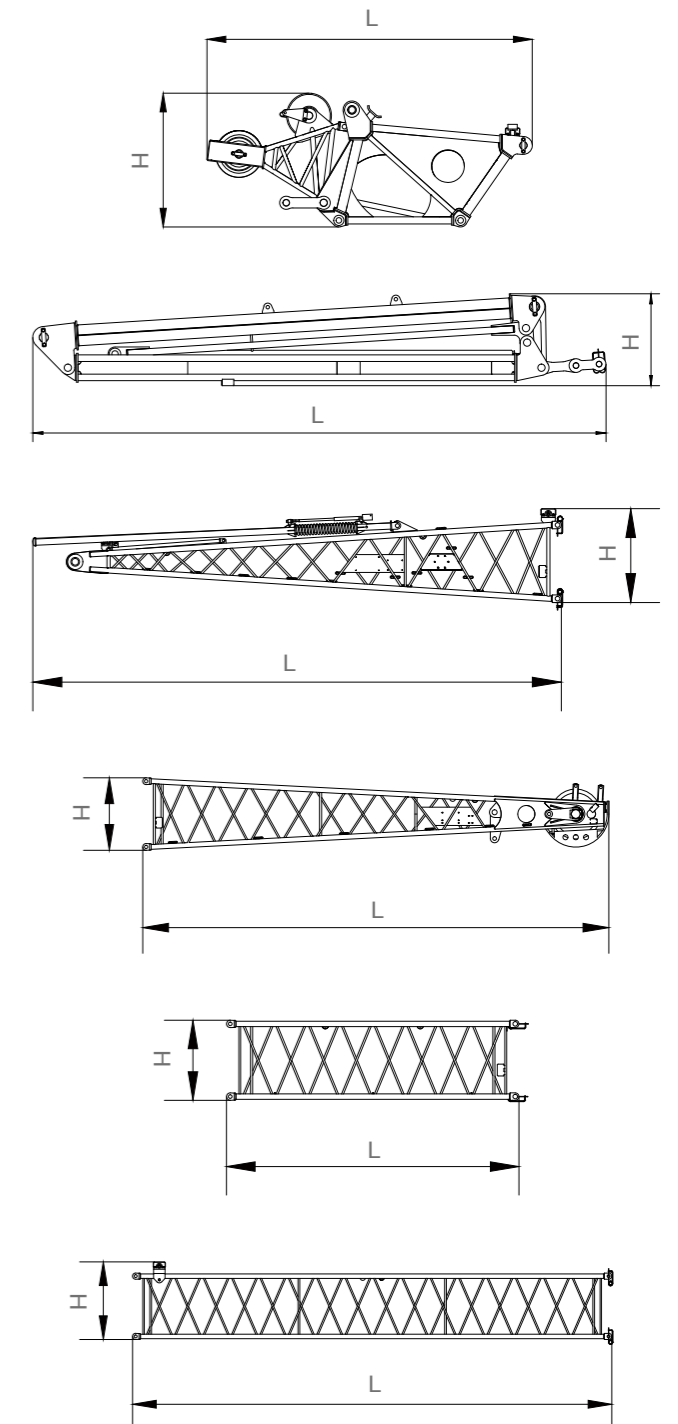

## TRANSPORT DIMENSIONS

<b>9m Insert of Luffing Jib</b>	<b>×1</b>
Length	9.14m
Width	1.63m
Height	1.91m
Weight	1.52t
<b>Boom Back-stop Device of LJ Operating Condition</b>	<b>×2</b>
Length	4.68m
Width	0.33m
Height	0.30m
Weight	0.33t
<b>Fixing Frame of LJ Operating Condition</b>	<b>×1</b>
Length	1.67m
Width	0.66m
Height	0.46m
Weight	0.08t

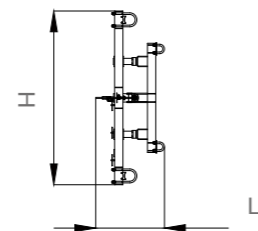
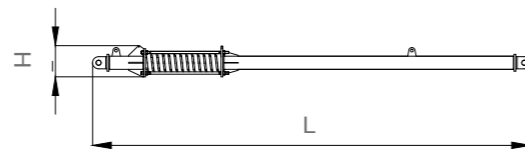
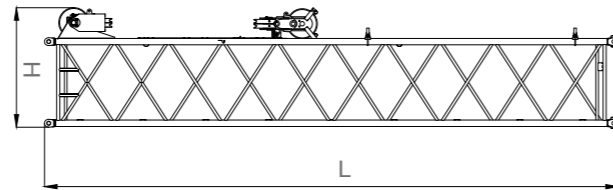

# SCC900E

- 13 Superstructure
- 15 Undercarriage
- 16 Operation Devices
- 17 Safety Devices



# SUPERSTRUCTURE

## 1) Superstructure Engine

- Standard Configuration: inline 6 cylinders turbocharging & intercooling.
- Rate Power/Speed: 194kW/2000rpm;
- Emission Standard: GB III
- Air Filter: Two-stage filtering system composed of air pre-filter and air filter.
- Fuel Tank: 400L

## 2) Electrical Control System

- The CAN bus technology is applied for data communication between controller, combined instrument (integrated load moment Indicator monitor and remote control terminal) and engine.
- Combined instrument can show parameters and working conditions such as engine rotating speed, fuel quantity, engine oil pressure, servo pressure, wind speed, engine working hours, and hoisting and boom angle, etc.

## 3) Hydraulic System

- Advanced hydraulic components are adopted, including main pump, main valve, joystick and motor reducer, which are efficient, reliable, stable and energy-saving.
- Independently controlled hydraulic oil cooling system is adopted.

## 4) Main and Auxiliary Hoisting Mechanisms

- Main and auxiliary winches are independently driven. The winch drum is directly driven by winch motor through reducer, and can rotate into two directions through the manipulation of winch handle to carry out lifting and lowering actions of the hook.
- The drum design ensures the multi-layer winding is always in order.

NO.1 Main and Auxiliary Hoisting Mechanisms

Main and Auxiliary Hoisting Mechanism	Rope speed of the outermost working layer	0~120m/min
	Wire rope diameter	φ24mm
	Rope length of main/ auxiliary winch	240m/160m
	Rated single line pull	9.2t

## 5) Luffing Mechanism

- The winch drum is directly driven by luffing motor through reducer, and can rotate into two directions through the manipulation of luffing handle to carry out lifting and lowering actions of the hook.
- The drum design ensures the multi-layer winding is always in order.

NO.2 Luffing Mechanism

Luffing Mechanism	Rope speed of the outermost working layer	0~58m/min
	Wire rope diameter	φ20mm
	Wire rope length of luffing winch	140m
	Rated single line pull	7t

## 6) Swing Mechanism

- The inner tothing swing drive can rotate 360°.
- Slewing lock: Pull up the locking pin after the completion of operation or during transportation can ensure the superstructure to be locked, which is convenient and reliable.
- Slewing ring: Sing-row ball type slewing ring
- Slewing Speed: 0~3.2rpm.

## 7) Cab

- SANY's newly designed and manufactured fully enclosed cab features with artistic styling and interior decoration. There are large glass windows, short and long distance beam headlight, and rear-view mirror for more open vision.
- It is equipped with well ventilated air conditioning and MP3 player. The seat, joystick and all control buttons are all ergonomically designed, which provides the operator with a more comfortable working environment.
- Armrest box: Joystick, electric switch, emergency stop button and ignition lock are installed on left and right armrest box and auxiliary controlling box. The armrest box is adjustable with the seat.
- Air conditioning provides heating and cooling air with optimized air duct and air outlet.

## 8) Counterweight

- The superposable tray and counterweight blocks are easy to assembly, disassembly and transport.
- Rear counterweight block: 30t. Tray: 9.5t×1
- Left counterweight block: 2.7t×3, right counterweight block: 2.7t×3, central counterweight block: 2.2t×2
- Undercarriage counterweight: 5t×2, installed on front and back of the chassis



## UNDERCARRIAGE

Each track frames has an independent traveling drive. The traveling motor drives the machine to achieve independent traveling and turning through drive wheel and reducer.

### 1) Telescopic Track

- Track frame can be expanded and retracted through cylinder.

### 2) Track tension

- Track tension can be adjusted by using hydraulic jack to push guide wheel to adjust clearance between shims

### 3) Crawler Shoes

- High strength alloy steel with higher durability.

## OPERATION DEVICES

### 1) Boom

- Lattice structure; main chord made of high strength structure steel; each section is connected with pins.
- Basic Boom: 6.5m boom tip and 6.5m boom base;
- Insert: 3m×2, 6m×1, 9m×4;
- Boom Length: 13m~61m

### 2) Fixed Jib

- Lattice structure; main chord made of high strength structure steel; each section is connected with pins.
- Basic Boom: 4.5m boom tip and 5m boom base;
- Insert: 4.5m×2;
- Fixed jib length: 9m~18m;
- Longest boom + jib: 52m boom+18m jib

### 3) Luffing Jib

- Lattice structure, main chord adopts high strength structural steel pipe. All sections are connected with pin.
- Basic Jib: 5m tip + 5m base;
- Insert: 3m×1, 6m×3;
- Luffing jib length: 19m~31m;
- Full extended boom + luffing jib: 43.3m +31m

### 4) Boom Extension

- Welded structure; It is jointed with boom through pin for auxiliary hook operation.
- Length of boom extension: 1.5m

### 5) Lifting Hook Block

- 100t lifting hook(single hook head), 6 pulley
- 50t lifting hook, 3 pulley
- 25t lifting hook, 1 pulley
- 9t ball hook
- (80t double-head hook and 6 pulleys are optional)

Notes: The above operation devices are complete configuration. The order contract shall prevail for specific configuration.

## SAFETY DEVICES

### 1) Assembly/Operation Mode Change-over Switch

In assembly mode, the hoisting limiter, boom angle limiter and LMI will be bypassed.

In operation mode, all safety devices and mechanisms will function.

### 2) Emergency Stop Function

In case of emergency, the operator can immediately shut down the entire machine by pressing the emergency stop button

### 3) Load Moment Indicator (LMI)

An independent safety control system fully controlled by computer. The load moment indicator can detect and show rated and actual load, working radius and boom angle.

Under normal operation condition, it can automatically cut the crane action to dangerous direction, and record the over-load information.

- Component: Display, angle sensing, load sensor.

### 4) Main and Auxiliary Hoisting Limiter

Composed of limit switch and hammer etc. on boom tip to prevent over hoisting of hook block. When the lifting hook is raised to a certain height, the limit switch will be activated. The buzzer on the control panel will alarm and the failure indicator will flash. The lifting operation of hook block will be automatically cut off.

### 5) Lowering Limiter of Main and Auxiliary Winch

Composed of movement trigger device and proximity switches to prevent wire rope from being over-released. When the wire rope is released near the last three loops, limit switch will work. The system will alarm through buzzer, sending alarm information to the display and automatically stop the lowering of winches.

### 6) Function Lock

If the function locking handle is not at proper position, all control handles will not function. It can prevent misuse and operational accident due to body impact when getting on or off the cab.

### 7) Drum Locking Device

There are electrically controlled locking devices for main winch, auxiliary winch and luffing winch. The action can be done only after the button is turned to the release position to prevent misuse of handle, thus ensuring the parking safety of winch during idle states.

### 8) Swing Locking Device

It can lock the machine at the front, back, left and right direction.

### 9) Boom Angle Limit

When boom angle is more than 80°, buzzer will give an alarm and the boom operation will be cut off. This protection function is controlled by LMI and travel switch.

### 10) Boom Back-stop Device

Composed of nesting tubing and spring. It buffers the energy of boom backwards tilting by spring force to prevent the boom from tilting backwards.

### 11) Boom Angle Indicator

The angle indicator device is fixed on the boom base near the cab for convenient view of operator.

### 12) Hook Latch

There is a baffle on the hook to prevent the wire rope fall off.

### 13) CCTV Monitoring System

Remote monitoring system is equipped for GPS positioning, GPRS data transfer, machine use inquiries, running data monitoring and analysis and remote fault diagnosis.

### 14) Lightning Protection Device

The lightning protection device (optional) combines a base (ground) device to effectively prevent damage to operator in the case of a lightning strike.

## SAFETY DEVICES

### 15) Three-color Load Alarm Light

Red, Yellow and Green lights indicate loading situations in Real-Time. If the actual load is less than 90% of the rated load, the Green Light will turn on. If the actual load is more than 90%, but less than 100% of the rated load, the yellow light will turn on with intermittent sound alarm. If the actual load is 100% of the rated load, the Red light will turn on with continuous sound alarm. If the actual load is 100% of the rated load, then the system will immediately cease the operation of the crane.

### 16) Audio and Visual Alarm

When the engine works, the light will flash; when at traveling or slewing operation state, the sound alarm will be given.

### 17) Slewing Alarm Device

When traveling or slewing, the slewing lamp will flash.

### 18) Illumination Light

The short-beam lamp at the front of cab, front angle adjustable far-beam lamp, lamp in cab and other lighting device at night are equipped to improve the visibility of construction.

### 19) Rearview Mirror

They are equipped at the right side of cab and on the handrail at the front of hood, to facilitate the monitoring of the back of the crane.

### 20) Pharos

It is on the top of boom for altitude lighting.

### 21) Anemometer

It is on the top of boom to monitor the wind speed in real time and to transfer data to the display in cab.

# SCC900E

21	Operating Condition Combination
22	H Operating Condition
26	Fixed Jib Operating Condition
31	LJ Operating Condition

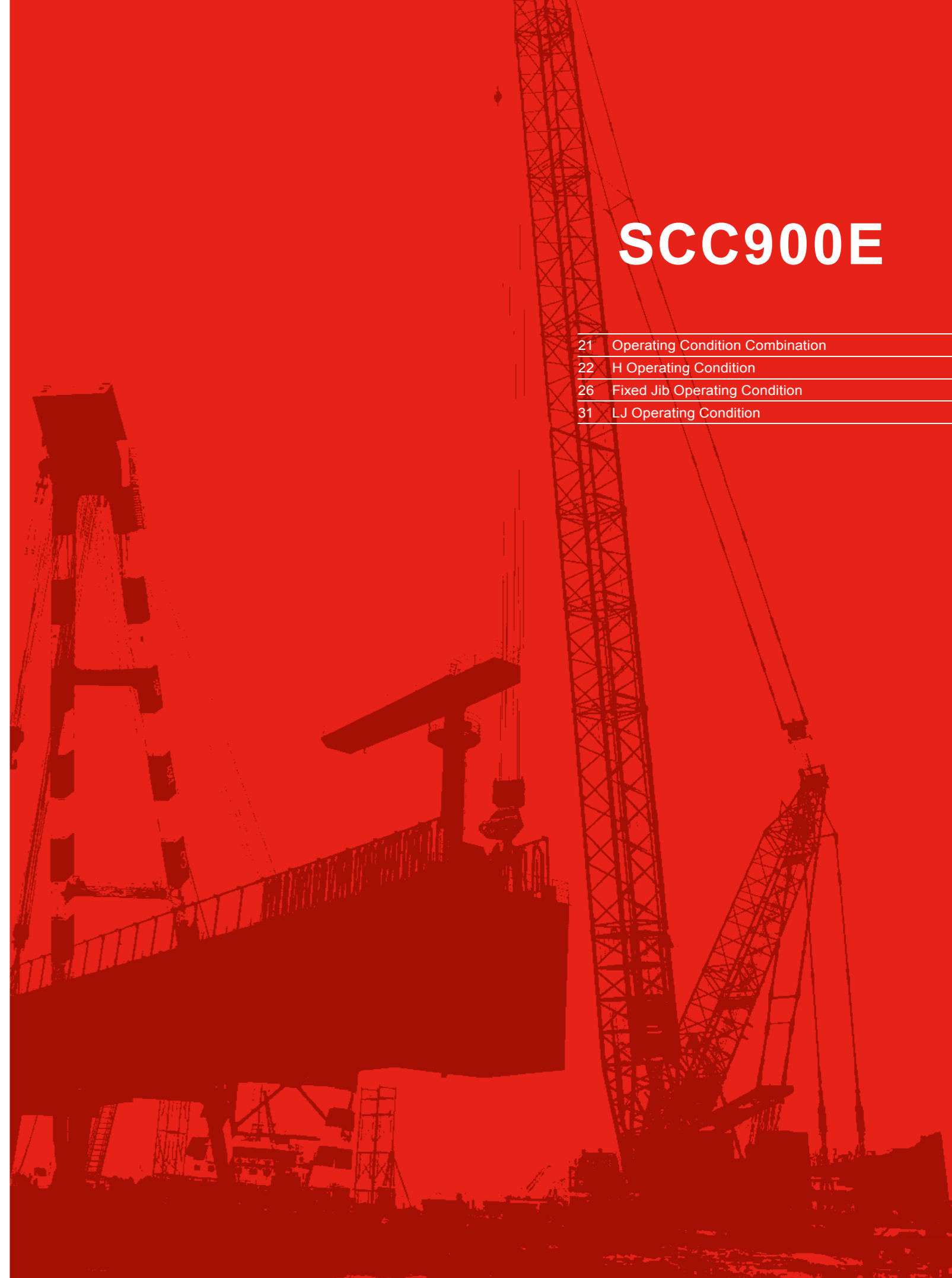

## OPERATING CONDITION COMBINATION

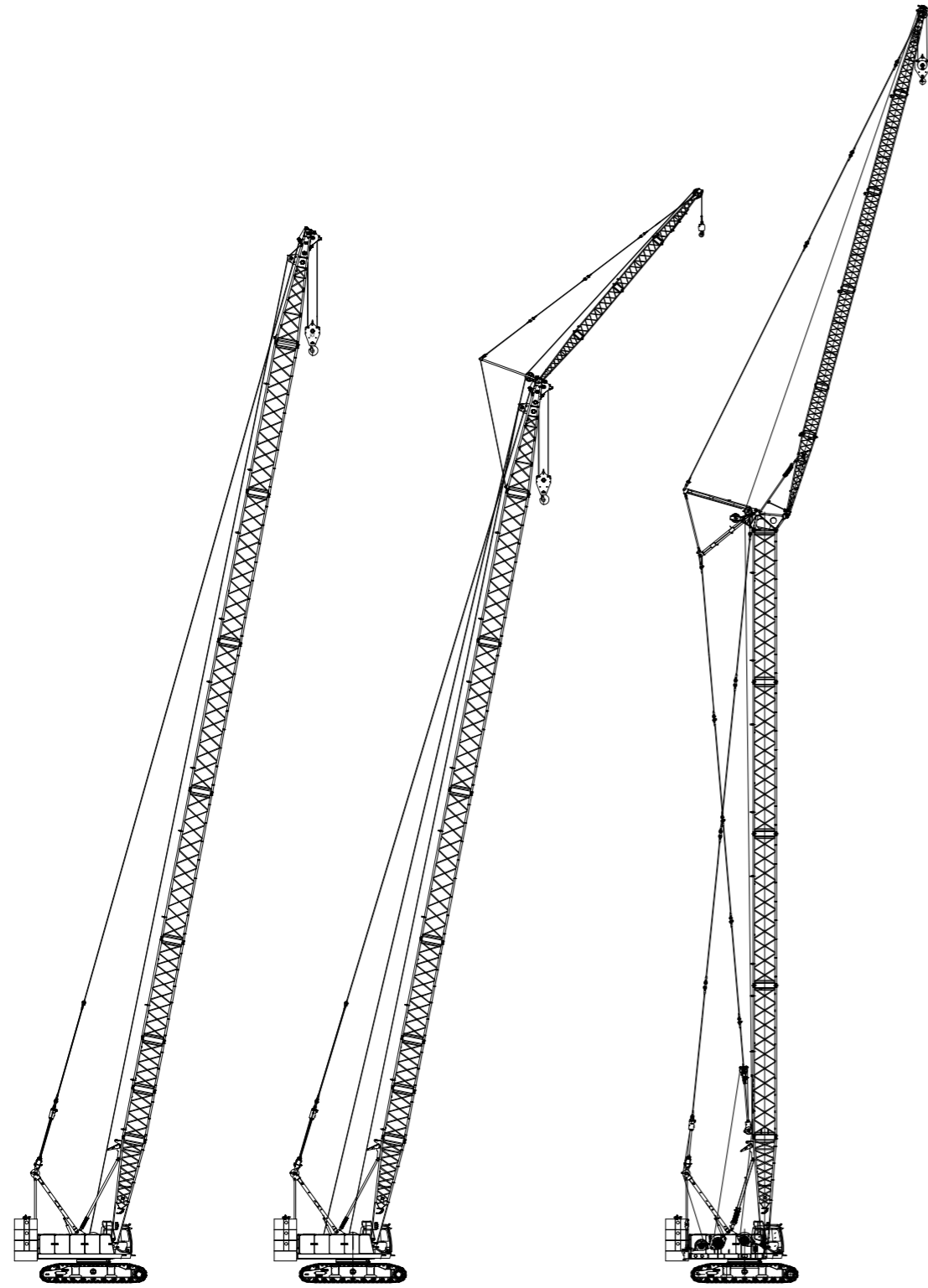

H Operating  
Condition: 13m-61m

FJ Operating Condition:  
Boom 37-52m, Jib 9m-18m

LJ Operating Condition:  
Boom 25.3m-43.3m, Jib: 19m-31m

## H OPERATING CONDITION

Length of boom (m)	Insert		
	3m	6m	9m
13	-	-	-
16	1	-	-
19	-	1	-
22	-	-	1
25	1	-	1
28	-	1	1
31	1	1	1
34	-	-	2
34	1	-	2
37	-	1	2
40	1	1	2
40	-	-	3
43	1	-	3
46	-	1	3
49	1	1	3
49	-	-	4
52	1	-	4
55	-	1	4
58	1	1	4
61	2	1	4

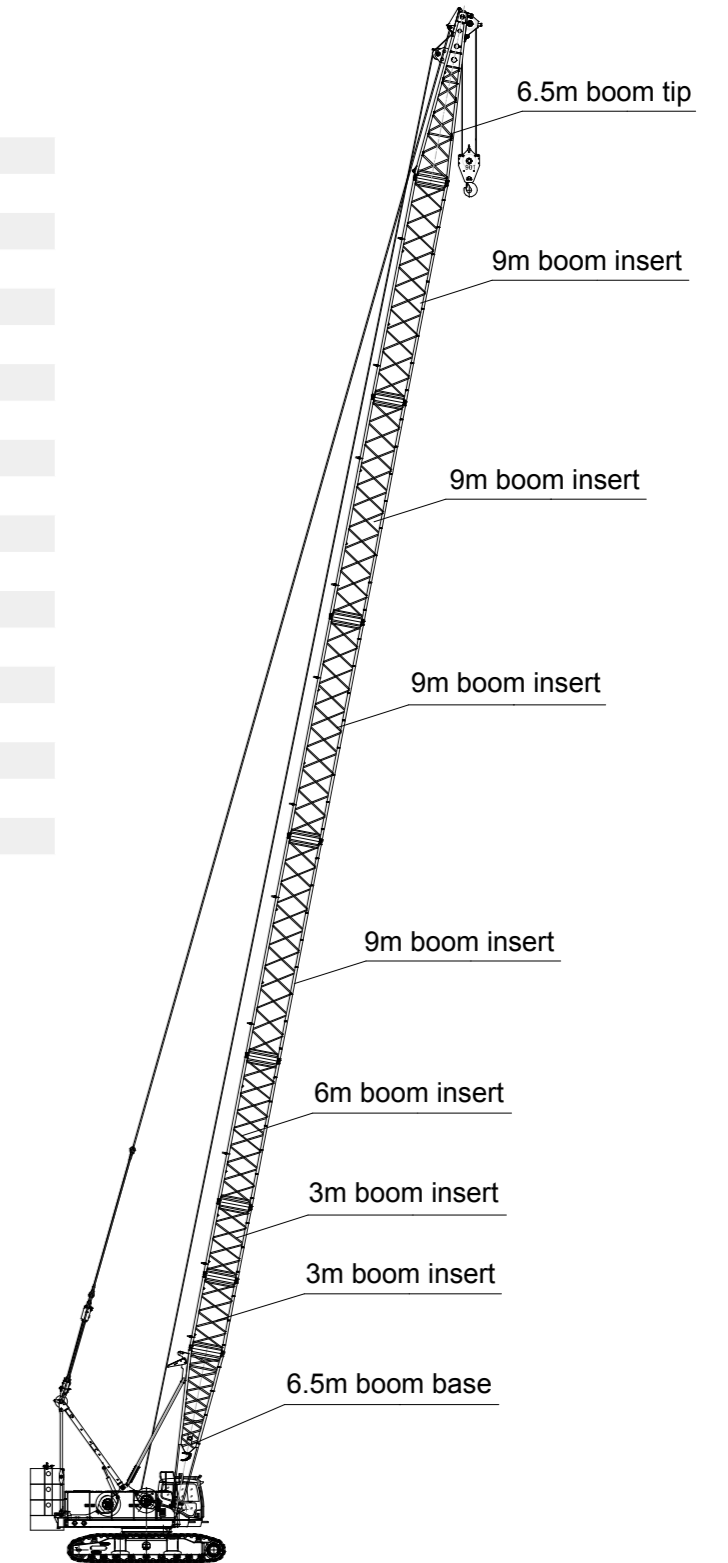

6.5m boom tip

9m boom insert

9m boom insert

9m boom insert

9m boom insert

6m boom insert

3m boom insert

3m boom insert

6.5m boom base

## H OPERATING CONDITION RANGE

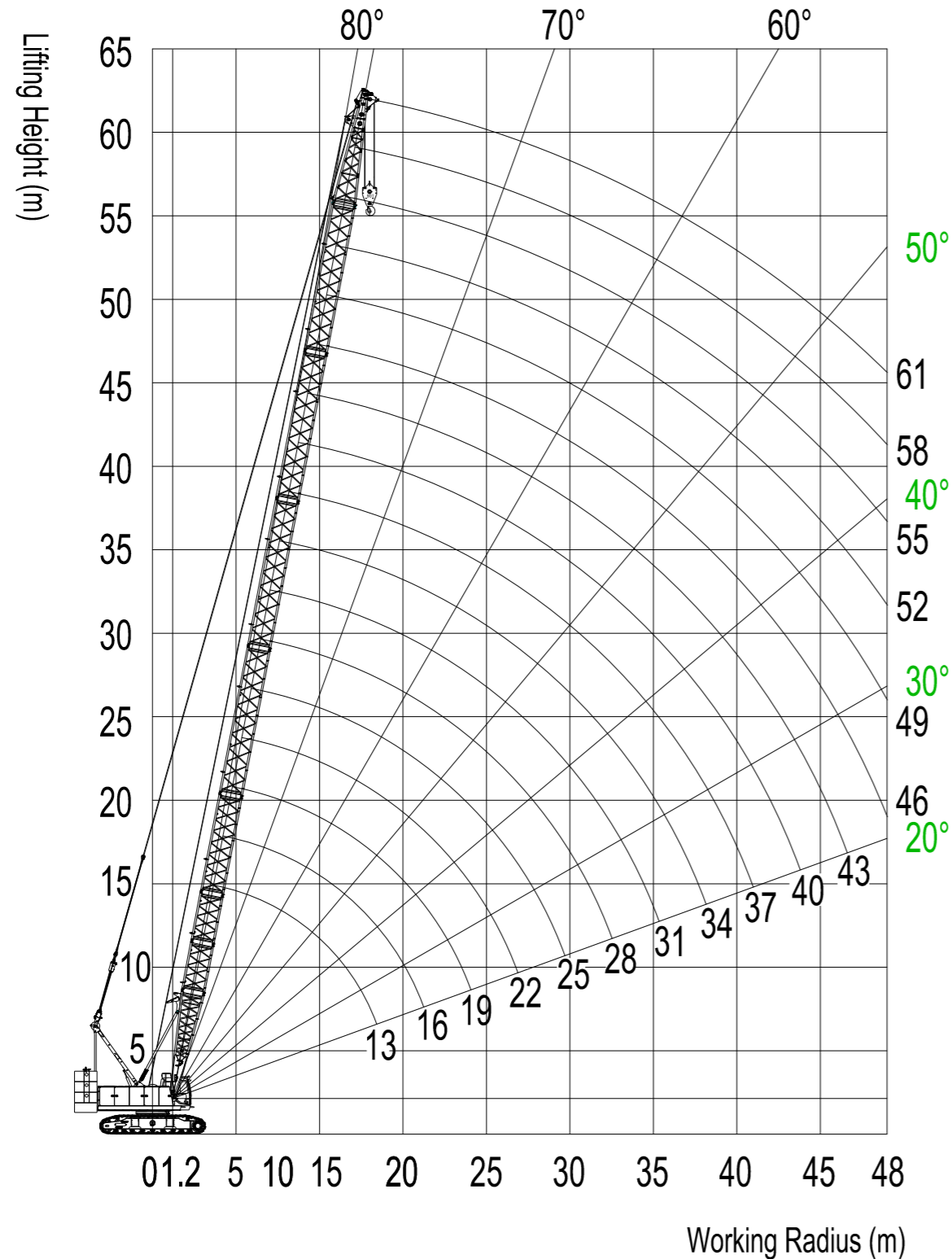

## BOOM LOAD CHARTS(H OPERATING CONDITION)

SCC900E Crawler Crane  
H Operating Condition Load Chart

Unit: (t)

Radius (m)	Boom (m)								
	13	16	19	22	25	28	31	34	
4	90								
4.5	80								
5	72	72							
5.5	65	65	65						
6	59.5	58.9	58.4	57.8					
6.5	52.6	52.1	51.7	51.3	50.7				
7	47.2	46.7	46.4	46	45.6	45.1			
7.5	42.7	42.3	42	41.7	41.3	41	40.5		
8	39	38.6	38.3	38	37.7	37.4	37.1	36.6	
9	33.2	32.8	32.6	32.4	32.1	31.8	31.6	31.3	
10	28.8	28.5	28.3	28.1	27.8	27.6	27.4	27.1	
11	25.4	25.1	24.9	24.8	24.5	24.3	24.1	23.8	
12	22.7	22.4	22.3	22.1	21.8	21.6	21.5	21.2	
13	20.5	20.2	20.1	19.9	19.7	19.5	19.3	19.1	
14		18.4	18.2	18.1	17.8	17.7	17.5	17.3	
15		16.8	16.7	16.5	16.3	16.1	16	15.8	
16		15.5	15.3	15.2	15	14.8	14.7	14.4	
18			13.2	13.1	12.8	12.7	12.5	12.3	
20				11.4	11.1	11	10.9	10.6	
22					9.8	9.7	9.5	9.3	
24					8.7	8.6	8.4	8.2	
26						7.6	7.5	7.3	
28							6.7	6.5	
30							6.1	5.8	
32								5.3	

Notes-Rated Load of Crane

1. The rated load in the table is the value under the condition that the non-traveling heavy load is lifted slowly and steadily from the solid and flat ground.
2. The rated load in the table is calculated based on 75% of the tipping load under wind speed of less than 9.8m/s.
3. The rated load in the table includes the weight of hook; the actual lifting capacity is the rated load minus the weight of all hoisting tools.
4. The length of installable boom is 37m~52m.
5. The track frame shall be expanded during lifting.
6. All values in load chart are applicable for 360°rotation.

# BOOM LOAD CHARTS(H OPERATING CONDITION)

**SCC900E Crawler Crane**  
**H Operating Condition Load Chart**

Unit: (t)

Radius (m)	Boom (m)									
	37	40	43	46	49	52	55	58	61	
9	31									
10	26.9	26.7	26.4							
11	23.6	23.5	23.2	23	22.7					
12	21	20.9	20.6	20.4	20.3	20				
13	18.9	18.7	18.5	18.3	18.2	17.9	17.7			
14	17.1	17	16.7	16.5	16.4	16.2	16	15.7	14	
15	15.6	15.4	15.2	15	14.9	14.7	14.5	14.3	13.5	
16	14.3	14.1	13.9	13.7	13.6	13.4	13.2	13	12.7	
18	12.2	12	11.8	11.6	11.5	11.3	11.1	10.9	10.7	
20	10.5	10.4	10.1	10	9.8	9.6	9.5	9.3	9.1	
22	9.2	9	8.8	8.7	8.5	8.3	8.2	8	7.8	
24	8.1	7.9	7.7	7.6	7.4	7.2	7.1	6.9	6.7	
26	7.2	7	6.8	6.7	6.5	6.3	6.2	6	5.8	
28	6.4	6.3	6	5.9	5.8	5.5	5.4	5.2	5	
30	5.7	5.6	5.4	5.2	5.1	4.9	4.7	4.6	4.3	
32	5.1	5	4.8	4.6	4.5	4.3	4.2	4	3.8	
34	4.6	4.5	4.3	4.1	4	3.8	3.7	3.5	3.3	
36	4.2	4.1	3.8	3.7	3.6	3.3	3.2	3	2.8	
38		3.7	3.4	3.3	3.2	2.9	2.8	2.6	2.4	
40			3.1	2.9	2.8	2.6	2.5	2.3	2.1	
42				2.6	2.5	2.3	2.1	2	1.7	
44				2.3	2.2	2	1.8	1.7	1.5	
46					1.9	1.7	1.6	1.4	1.2	
48						1.5	1.3	1.2	0.9	

**Notes-Rated Load of Crane**

1. The rated load in the table is the value under the condition that the non-traveling heavy load is lifted slowly and steadily from the solid and flat ground.
2. The rated load in the table is calculated based on 75% of the tipping load under wind speed of less than 9.8m/s.
3. The rated load in the table includes the weight of hook; the actual lifting capacity is the rated load minus the weight of all hoisting tools.
4. The length of installable boom is 37m~52m.
5. The track frame shall be expanded during lifting.
6. All values in load chart are applicable for 360° rotation.

# FIXED JIB OPERATING CONDITION

Jib Length	Insert
m	4.5m
9	-
13.5	1
18	2

Longest Boom+ jib: 52m+18m

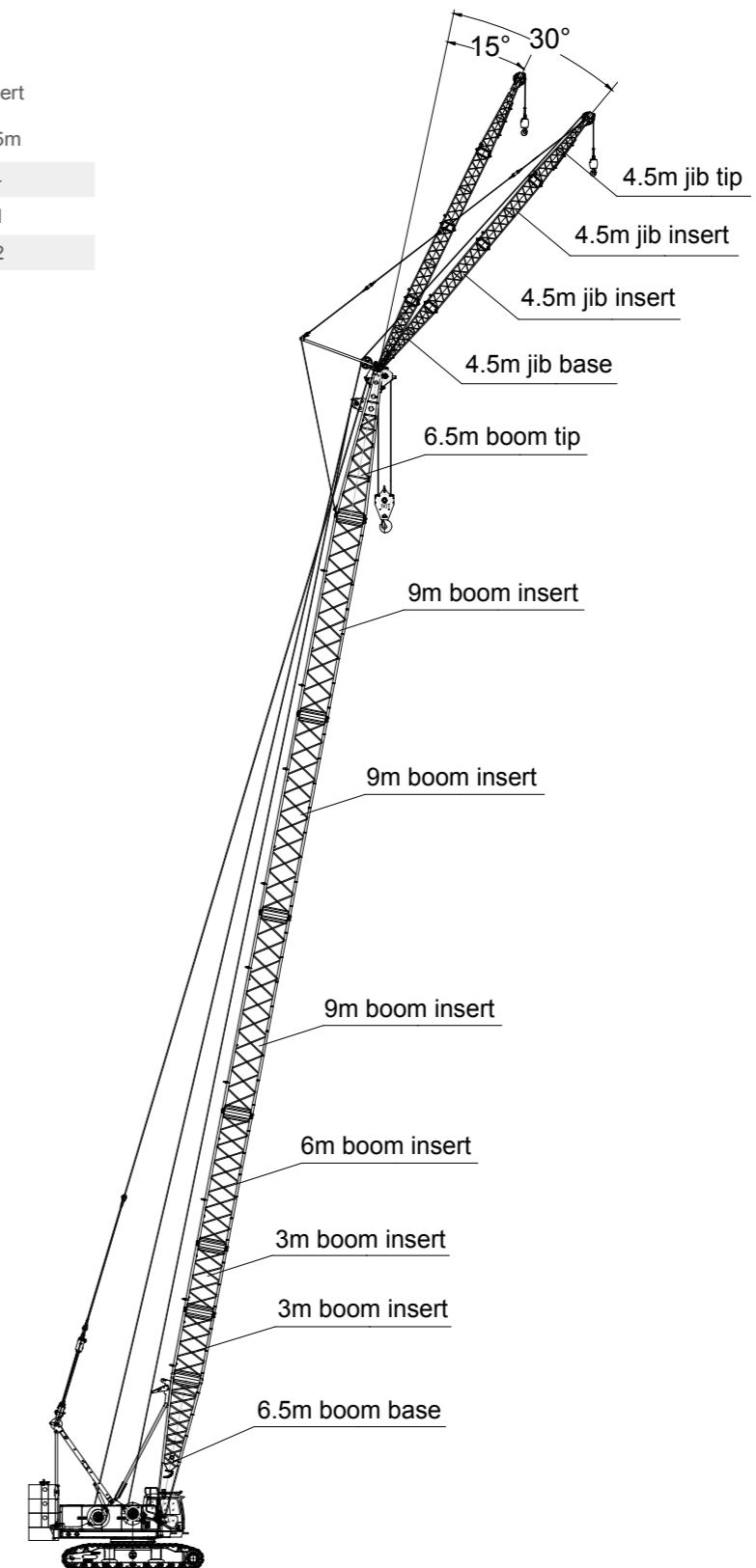

# FIXED JIB OPERATING RANGE

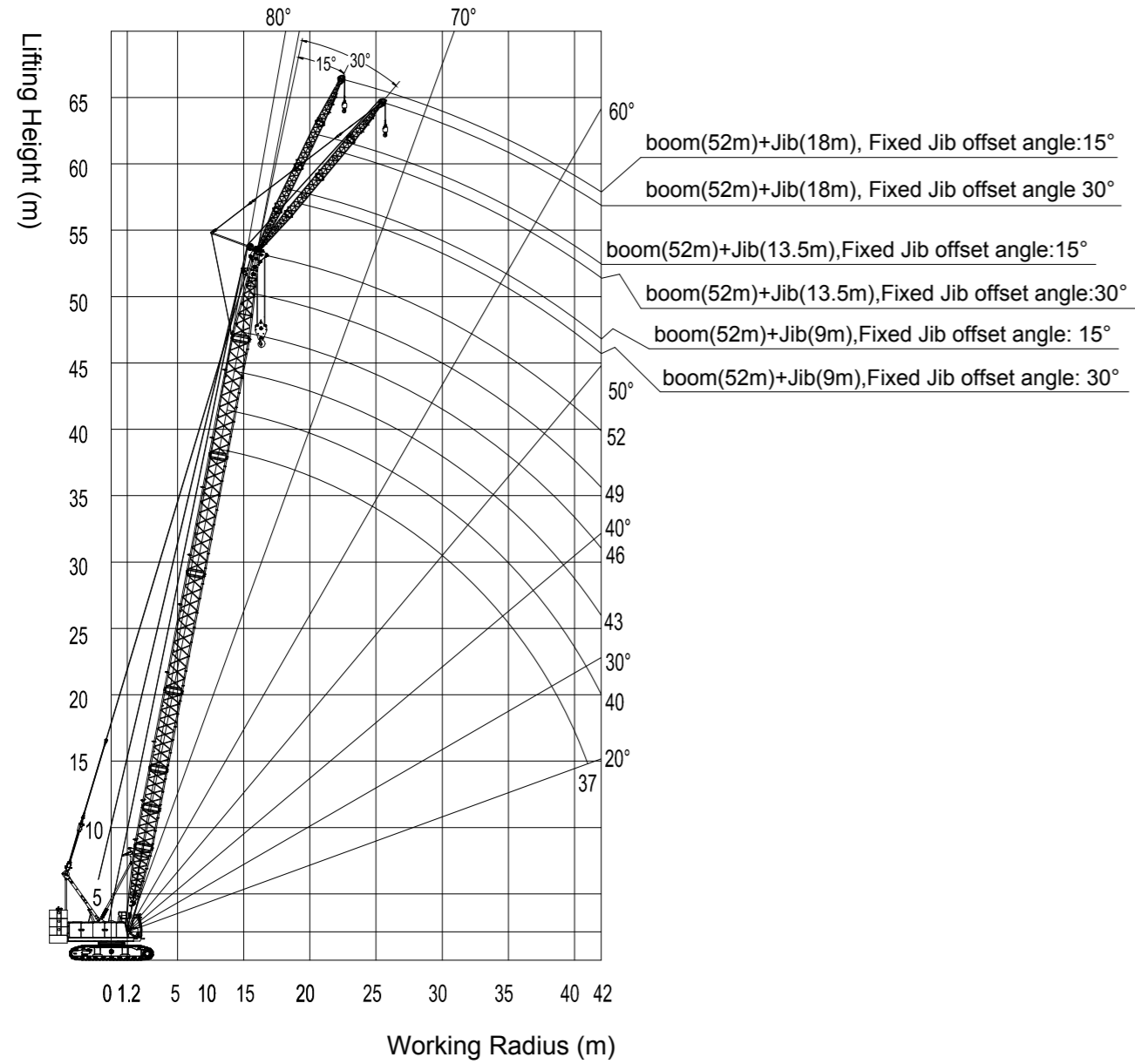

# FIXED JIB LOAD CHARTS

SCC900E Crawler Crane  
Fixed Jib Load Chart

Unit: (t)

Boom Length (m)		37					
Jib length (m)		9		13.5		18	
Fixed jib offset angle/ working radius (m)		15°	30°	15°	30°	15°	30°
14		8					
15		8	8	7			
16		8	8	7	6.5		
18		8	8	7	6.5	5.5	
20		8	8	7	6.5	5.5	
22		8	8	7	6.5	5.5	5
24		7.8	8	7	6	5.5	4.5
26		6.9	7.1	7	6	5.5	4.5
28		6.2	6.3	6.3	5.5	5.5	4.2
30		5.5	5.6	5.6	5.5	5	4
32		5	5.1	5.1	5	5	4
34		4.5	4.6	4.6	4.7	4.6	3.9
36		4	4.1	4.1	4.3	4.2	3.8
38		3.7	3.7	3.7	3.9	3.8	3.7
40		3.3	3.4	3.4	3.5	3.4	3.6
42		3	3	3.1	3.2	3.1	3.2
Boom length (m)		40					
Jib length (m)		9		13.5		18	
Fixed jib offset angle/ working radius (m)		15°	30°	15°	30°	15°	30°
14		8					
15		8	8	7			
16		8	8	7	6.5		
18		8	8	7	6.5	5.5	
20		8	8	7	6.5	5.5	
22		8	8	7	6.5	5.5	5
24		7.7	7.9	7	6	5.5	4.5
26		6.8	7	6.9	6	5.5	4.5
28		6	6.2	6.1	5.5	5.5	4.5
30		5.4	5.5	5.5	5.5	5.5	4
32		4.9	5	4.9	5	4.5	4
34		4.4	4.5	4.5	4.6	4.5	4
36		3.9	4	4	4.2	4.1	3.9
38		3.5	3.6	3.6	3.8	3.7	3.8
40		3.2	3.3	3.3	3.4	3.3	3.5
42		2.9	2.9	3	3.1	3	3.1

# FIXED JIB LOAD CHARTS

## SCC900E Crawler Crane Fixed Jib Load Chart

Unit: (t)

Boom Length (m)		43					
Jib length (m)		9		13.5		18	
Fixed jib offset angle/ working radius (m)		15°	30°	15°	30°	15°	30°
14		8					
15		8					
16		8	8	7			
18		8	8	7			
20		8	8	7	6.5	5.5	
22		8	8	7	6.5	5.5	5
24		7.5	7.7	7	6.5	5.5	5
26		6.6	6.8	6.7	6	5.5	4.5
28		5.9	6	6	6	5.5	4.5
30		5.2	5.4	5.3	5.5	5	4
32		4.7	4.8	4.8	5	4.5	4
34		4.2	4.3	4.3	4.5	4	4
36		3.7	3.8	3.8	4	3.9	4
38		3.4	3.4	3.4	3.6	3.5	3.7
40		3	3.1	3.1	3.2	3.1	3.3
42		2.7	2.8	2.8	2.9	2.8	3
Boom length (m)		46					
Jib length (m)		9		13.5		18	
Fixed jib offset angle/ working radius (m)		15°	30°	15°	30°	15°	30°
14		8					
15		8					
16		8	8	7			
18		8	8	7			
20		8	8	7	6.5	5.5	
22		8	8	7	6.5	5.5	
24		7.3	7.6	7	6.5	5.5	5
26		6.5	6.7	6.6	6	5.5	4.5
28		5.7	5.9	5.8	6	5.5	4.5
30		5.1	5.3	5.2	5.5	5	4.5
32		4.5	4.7	4.6	4.9	4.7	4
34		4	4.2	4.1	4.4	4.2	4
36		3.6	3.7	3.7	3.9	3.8	4
38		3.2	3.3	3.3	3.5	3.4	3.6
40		2.9	3	3	3.1	3	3.2
42		2.6	2.6	2.7	2.8	2.7	2.9

# FIXED JIB LOAD CHARTS

## SCC900E Crawler Crane Fixed Jib Load Chart

Unit: (t)

Boom Length (m)		49					
Jib length (m)		9		13.5		18	
Fixed jib offset angle/ working radius (m)		15°	30°	15°	30°	15°	30°
14							
15		8					
16		8	8	7			
18		8	8	7			
20		8	8	7	6.5	5.5	
22		8	8	7	6.5	5.5	
24		7.2	7.5	7	6.5	5.5	5
26		6.3	6.6	6.5	6	5.5	4.5
28		5.6	5.8	5.7	5.5	5.5	4.5
30		5	5.1	5.1	5.4	5.2	4.5
32		4.4	4.6	4.5	4.8	4.6	4
34		3.9	4.1	4	4.3	4.1	4
36		3.5	3.6	3.6	3.8	3.7	3.9
38		3.1	3.2	3.2	3.4	3.3	3.5
40		2.8	2.9	2.9	3	2.9	3.1
42		2.5	2.5	2.5	2.7	2.6	2.8
Boom length (m)		52					
Jib length (m)		9		13.5		18	
Fixed jib offset angle/ working radius (m)		15°	30°	15°	30°	15°	30°
14							
15		8					
16		8	8	7			
18		8	8	7			
20		8	8	7	6.5	5.5	
22		8	8	7	6.5	5.5	
24		7	7.3	7	6.5	5.5	5
26		6.2	6.4	6.3	6.5	5.5	5
28		5.4	5.6	5.6	5.5	5.5	4.5
30		4.8	5	4.9	5.2	5	4.5
32		4.2	4.4	4.3	4.6	4.4	4
34		3.7	3.9	3.9	4.1	3.9	4
36		3.3	3.4	3.4	3.6	3.5	3.8
38		2.9	3	3	3.2	3.1	3.4
40		2.6	2.7	2.7	2.9	2.7	3
42		2.3	2.4	2.4	2.5	2.4	2.6



## LJ OPERATING CONDITION

Boom Length (m)	Insert			
	Special 9m	3m	6m	9m
25.3	1	-	-	1
28.3	1	1	-	1
31.3	1	-	1	1
34.3	1	-	-	2
37.3	1	1	-	2
40.3	1	-	1	2
43.3	1	-	-	3

Jib length (m)	Insert	
	3m	6m
19	1	1
22	-	2
25	1	2
28	-	3
31	1	3

Longest boom+jib: 43.3m+31m

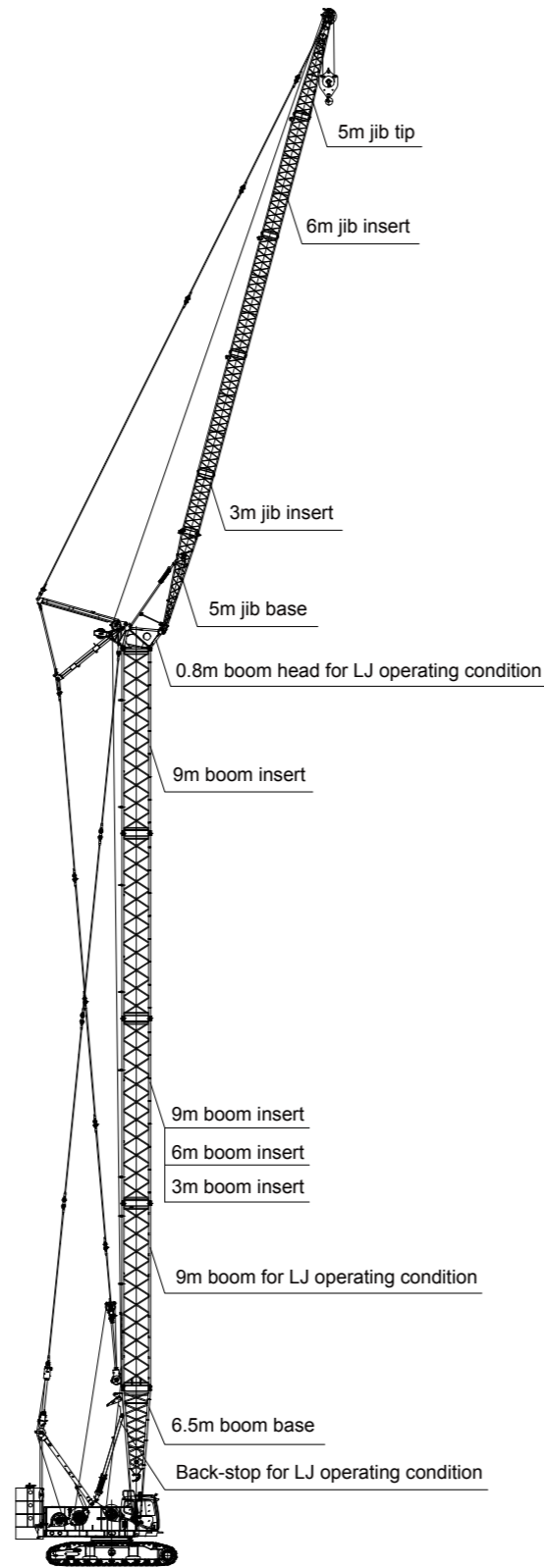

## LJ OPERATING CONDITION RANGE

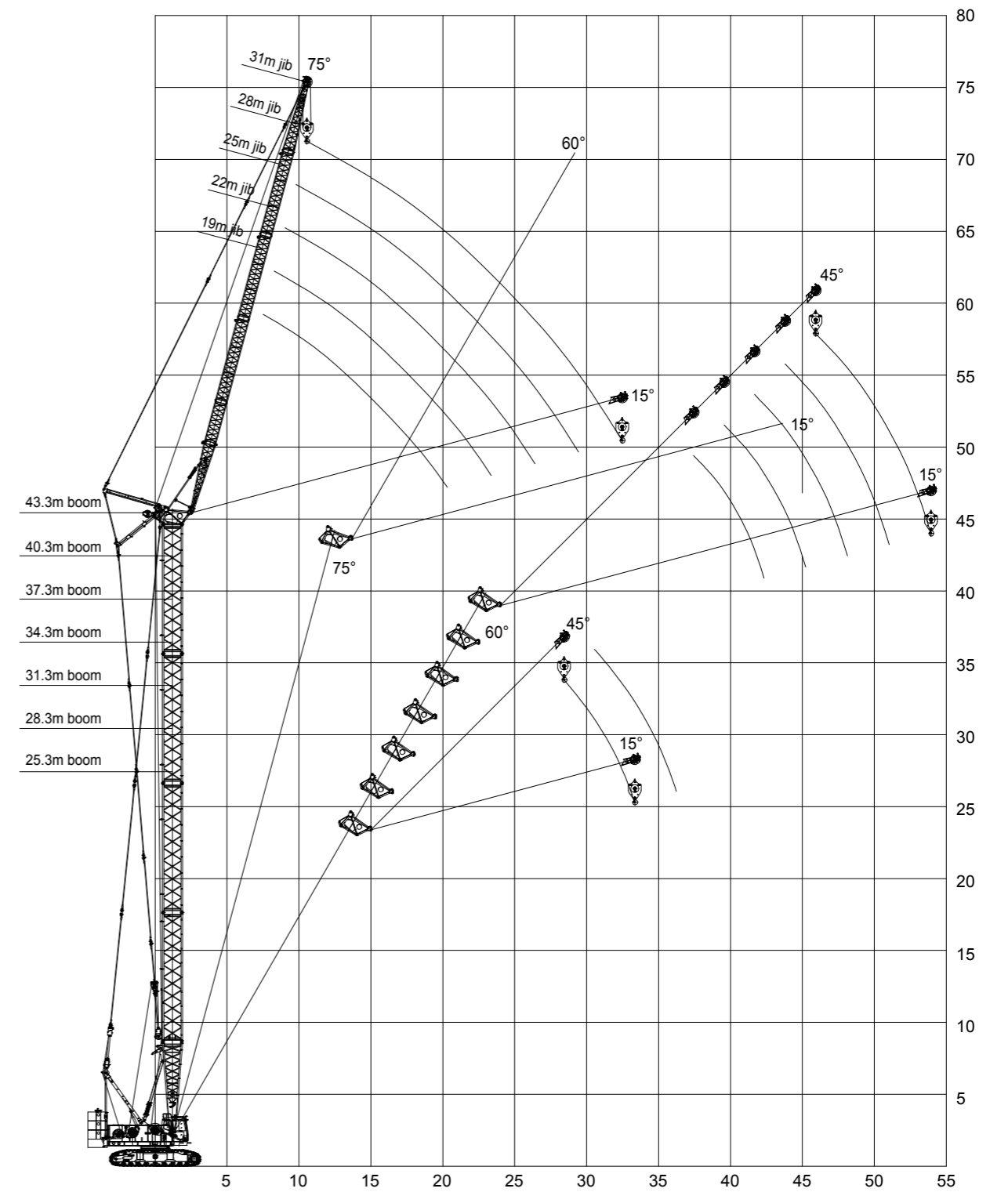

# LJ OPERATING CONDITION LOAD CHART

## SCC900E Crawler Crane- LJ Operating Condition Load Chart

Boom Length (m)	25.3m						28.3m								
	19m			22m			19m			22m			25m		
Jib Length (m)	19m	22m	25m	19m	22m	25m	19m	22m	25m	19m	22m	25m	19m	22m	25m
Boom Angle Radius	90°	75°	60°	90°	75°	60°	90°	75°	60°	90°	75°	60°	90°	75°	60°
7	18.4/7.4						18.4/7.4								
8	18.4			18.4/8.2			18.4			18.4/8.2					
9	18.4			18.4			18.4			18.4			18.4		
10	17.8			17.8			17.8			17.8			17.8		
12	16.5			16.5			16.5			16.5			16.5		
14	15.0			15.0			15.0			15.0			15.0		
16	12.5			12.5			12.5			12.5			12.5		
18	10.5	9.5/18.4		10.5			10.5	9.4/19.3		10.5			10.5		
20	8.7	9.0		9.0			8.7	8.8		9.0	5.8/20.8		9.0		
22	7.8/20.9	8.1		8.3	8.0		7.8/20.9	7.9		8.3	7.8		8.3	5.2/22.3	
24		7.3		6.5/23.8	7.2			7.2		6.5/23.8	7.1		7.5	7.0	
26		6.7			6.6			6.5			6.4		6.2	6.4	
28		6.2/27.4	5.4/28.4		6.0			6.0	4.8/29.9		5.9		5.5/26.6	5.8	
30			5.1		5.6	4.7/30.6		5.7/28.2	4.8		5.5			5.4	
32			4.7		5.4/30.3	4.6			4.5		5.2/31	4.3/32.1		5.0	
34			4.5/33.3			4.3			4.2			4.1		4.4/33.9	3.9/34.2
36						4.0			4.0/34.8			3.8			3.7
38						3.9/36.2						3.5/37.7			3.5
40															3.3
42															3.2/40.6
44															
46															
48															
50															
52															
54															

# LJ OPERATING CONDITION LOAD CHART

## SCC900E Crawler Crane- LJ Operating Condition Load Chart

Boom Length (m)	31.3m												
	19m			22m			25m			28m			
Jib Length (m)	19m	22m	25m	19m	22m	25m	19m	22m	25m	19m	22m	25m	
Boom Angle Radius	90°	75°	60°	90°	75°	60°	90°	75°	60°	90°	75°	60°	
7	18.4/7.4												
8	18.4			18.4/8.2									
9	18.4			18.4					17.5			14.8/9.8	
10	17.5			17.5					17.0			14.5	
12	16.5			16.5					16.0			13.6	
14	15.0			15.0					14.5			12.7	
16	12.5			12.5					12.5			11.6	
18	10.5			10.5					10.5			10.5	
20	8.7	8.4/20.1		9.0	7.8/21.6		9.0					9.0	
22	7.8/20.9	7.8		8.3	7.7		8.3	7.1/23				8.3	
24		7.0		6.5/23.8	6.9		7.5	6.8				7.5	6.4/24.5
26		6.4			6.3		6.2	6.2				6.8	6.1
28		5.9			5.8		5.5/26.6	5.7				5.8	5.6
30		5.5/28.9	4.4/31.4		5.3			5.3				5.0/29.5	5.2
32			4.3		4.8/31.8	4.0/33.6		4.9					4.8
34			4.0			3.9		4.5	3.6/35.7				4.5
36			3.7			3.6		4.3/34.7	3.6			4.2	3.2/37.8
38			3.6/36.3			3.4			3.3			4.0/37.5	3.2
40						3.2/39.2			3.1				3.0
42									2.9				2.8
44									2.8/42.1				2.6/45
46													
48													
50													
52													
54													

# LJ OPERATING CONDITION LOAD CHART

## SCC900E Crawler Crane- LJ Operating Condition Load Chart

Boom Length (m) 34.3m															
Jib Length (m)	19m			22m			25m			28m			31m		
Boom Angle Radius	90°	75°	60°	90°	75°	60°	90°	75°	60°	90°	75°	60°	90°	75°	60°
7	18.4/7.4														
8	18.4			18.4/8.2											
9	18.4			18.4			17.2			14.2/9.8					
10	17.5			17.5			16.6			14.0			12.5/10.6		
12	16.5			16.5			15.3			13.2			11.7		
14	15.0			15.0			14.0			12.5			10.9		
16	12.5			12.5			12.5			10.8			10.0		
18	10.5			10.5			10.5			9.7			9.4		
20	8.7	7.9/20.9		9.0			9.0			8.6			8.5		
22	7.8/20.9	7.6		8.3	7.3/22.3		8.3	6.8/23.9		8.0			7.9		
24		6.9		6.5/23.8	6.8		7.5	6.7		7.2	6.2/25.4		7.2		
26		6.3			6.2		6.0	6.1		6.5	6.0		6.5	5.6/26.9	
28		5.7			5.7		5.3/26.6	5.6		5.5	5.5		6.2	5.4	
30		5.2/29.7			5.2			5.1		4.8/29.5	5.1		5.6	5.0	
32			3.9/32.9		4.8			4.8			4.7		4.3	4.6	
34			3.8		4.6/32.5	3.6/35.1		4.4			4.4		4.0/32.4	4.3	
36			3.5			3.5		4.1/35.5	3.2/37.2		4.1			4.0	
38			3.2/37.8			3.2			3.1		3.8	3.0/39.3		3.7	
40						3.0			2.9		3.6/38.4	2.9		3.5	2.6/41.4
42						2.9/40.7			2.8			2.7		3.3/41.3	2.6
44									2.6/43.6			2.5			2.4
46												2.4			2.3
48												2.3/46.5			2.2
50															2.1/49.4
52															
54															

# LJ OPERATING CONDITION LOAD CHART

## SCC900E Crawler Crane- LJ Operating Condition Load Chart

Boom Length (m) 37.3m															
Jib Length (m)	19m			22m			25m			28m			31m		
Boom Angle Radius	90°	75°	60°	90°	75°	60°	90°	75°	60°	90°	75°	60°	90°	75°	60°
7	18.4/7.4														
8	18.4			18.4/8.2											
9	18.4			18.4			16.5			14.2/9.8					
10	17.5			17.5			15.8			13.9			12.3/10.6		
12	16.5			16.2			14.5			13.0			11.5		
14	15.0			14.6			13.3			12.0			10.8		
16	12.5			12.5			12.1			10.8			10.0		
18	10.5			10.5			10.5			9.7			9.2		
20	8.6	7.5/21.6		9.0			9.0			8.6			8.5		
22	7.3/20.9	7.4		8.3	6.9/23.1		8.3			8.0			7.8		
24		6.7		6.5/23.8	6.6		7.5	6.8/24.6		7.2			7.2		
26		6.1			6.0		6.0	5.9		6.5	5.7/26.1		6.5	5.4/27.6	
28		5.6			5.0		5.3/26.6	5.4		5.5	5.3		6.0	5.3	
30		5.2			5.1			5.0		4.8/29.5	4.9		5.6	4.8	
32			5.0/30.5		4.7			4.6			4.6		4.3	4.5	
34			3.3/34.4		4.5/33.4			4.3			4.2		4.0/32.4	4.1	
36			3.3		3.1/36.6			4.0			3.9			3.9	
38			3.1		3.0			3.9/36.3	2.7/38.7		3.7			3.6	
40			3.0/39.3		2.8			2.7			3.5/39.2	2.6/40.8		3.4	
42					2.7			2.6				2.5		3.2	2.2/42.9
44								2.6/42.2			2.4		2.3	3.2/42.1	2.2
46											2.3/45.1		2.2		2.1
48												2.1			2.0
50															1.9
52															1.8/50.9
54															

# LJ OPERATING CONDITION LOAD CHART

## SCC900E Crawler Crane-LJ Operating Condition Load Chart

Boom Length (m) 40.3m															
Jib Length (m)	19m			22m			25m			28m			31m		
Boom Angle Radius	90°	75°	60°	90°	75°	60°	90°	75°	60°	90°	75°	60°	90°	75°	60°
7	18.4/7.4														
8	18.4			18.2/8.2											
9	18.4			17.6			15.6			14.2/9.8					
10	17.5			16.7			14.9			13.3			12.3/10.6		
12	16.5			15.1			13.7			12.4			11.0		
14	14.5			13.6			12.5			11.4			10.2		
16	12.5			12.1			11.3			10.4			9.5		
18	10.5			10.5			10.2			9.5			8.8		
20	8.5			9.0			8.9			8.6			8.0		
22	7.1/20.9	6.8/22.4		8.3	6.4/23.9		8.2			7.8			7.4		
24		6.5		6.5/23.8	6.4		7.5	6.6/25.4		7.1			6.8		
26		6.0			5.9		5.8	5.8		6.5	5.4/26.9		6.2		
28		5.5			5.4		5.0/26.6	5.3		5.3	5.2		5.7	5.1/28.4	
30		5.0			5.0			4.9		4.5/29.5	4.8		5.2	4.7	
32		4.7/31.3			4.6			4.5			4.4		4.3	4.3	
34			3.1/35.9		4.3			4.2			4.1		4.0/32.4	4.0	
36			3.1		4.2/34.2			3.9			3.8			3.7	
38			2.9			2.9/38.1		3.7/37.1			3.6			3.5	
40			2.7			2.7			2.6/40.2		3.4			3.3	
42			2.6/40.8			2.5			2.4			2.2/42.3		3.1	
44						2.3/43.7			2.2			2.2		3.0/42.8	2.0/44.4
46									2.1			2.0			1.9
48								2.0/46.6				1.9			1.8
50												1.8/49.5			1.7
52															1.6
54															1.5/52.4

# LJ OPERATING CONDITION LOAD CHART

## SCC900E Crawler Crane-LJ Operating Condition Load Chart

Boom Length (m) 43.3m															
Jib Length (m)	19m			22m			25m			28m			31m		
Boom Angle Radius	90°	75°	60°	90°	75°	60°	90°	75°	60°	90°	75°	60°	90°	75°	60°
7	18.4/7.4														
8	18.4			17.2/8.2											
9	18.2			16.6			14.8			14.0/9.8					
10	17.3			15.8			14.2			12.7			11.0/10.6		
12	15.5			14.3			13.0			11.8			10.6		
14	13.8			12.8			11.8			10.9			9.8		
16	12.3			11.5			10.7			9.9			9.1		
18	10.5			10.3			9.6			9.1			8.3		
20	8.4			9.0			8.8			8.3			7.7		
22	7.0/20.9	6.5/23.2		8.3			7.9			7.5			7.0		
24		6.3		6.5/23.8	6.0/24.7		7.2			6.8			6.4		
26		5.8			5.7		5.8	5.4/26.2		6.2	5.1/27.7		5.9		
28		5.3			5.2		4.8/26.6	5.1		5.3	5.0		5.4	4.6/29.2	
30		4.9			4.8			4.7		4.2/29.5	4.6		5.0	4.5	
32		4.5			4.5			4.4			4.3		4.2	4.2	
34								4.2			4.1		4.0	3.9/32.4	3.9
36											3.8		3.7		3.6
38											2.8/37.4		4.0/34.9		3.8
40											2.7		2.5/39.6		3.5/37.8
42											2.5		2.5		2.2/41.7
44											2.4		2.3		2.2
46											2.3/42.3		2.2		2.1
48													2.1/45.2		2.0
50														1.8/48.1	1.7
52														1.6/51	1.5
54															1.4/53.9



## Quality Changes the World

### **SANY HEAVY INDUSTRY CO., LTD.**

Address: SANY Industrial Park, Economic and Technological  
Development Zone, Changsha, Hunan, China

Service Hotline: +0086-4006-098-318

E-mail: [crd@sany.com.cn](mailto:crd@sany.com.cn)

For more information, please visit: [www.sanygroup.com](http://www.sanygroup.com)

