

SAC1800

SAC1800 ALL-TERRAIN CRANE
180 TONS LIFTING CAPACITY

Quality Changes the World

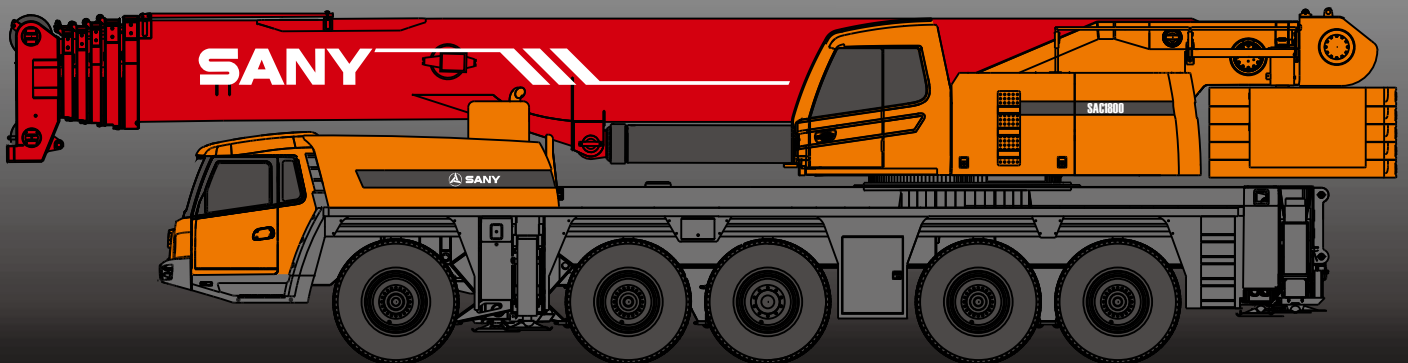

SANY

























■ SANY Automobile Hoisting Machinery is one of the core business unit of Sany Heavy Industry, mainly engaged in the research and development of high end, mid to large tonnage crane series, including mobile crane, crawler crane, tower crane and loader crane. It has two industrial parks in Ningxiang and Huzhou, since entering the market, the products of Sany Automobile Hoisting Machinery have received worldwide recognition with advanced technology, lean manufacturing, high reliability and excellent service.



SANY ALL-TERRAIN CRANE

CONTENT

04	Icon
05	Selling points
06	Introduction
09	Dimension
10	Technical Parameter
11	Operation Condition
12	Load Chart
33	Counterweight sketch Map
35	Wheel Crane Family Map

	Cab		Carrier frame		Suspension system
	Hydraulic system		Outriggers		Telescopic boom
	Control system		Engine		Lattice jibs
	Telescopic system		Transmission system		Superlift devices
	Luffing system		Drive/Steer		Luffing lattice jib
	Slewing		Axles		winch mechanism:
	Counterweight		Tyres		
	Safety system		Brakes system		
	Hoist system		Electrical system		



Excellent and stable chassis performance

The use of innovative 5-axle chassis design and multi braking modes provide more reliable traveling performance for chassis. With tipping early-warning technology, highly stable overall operation and safety can be achieved.

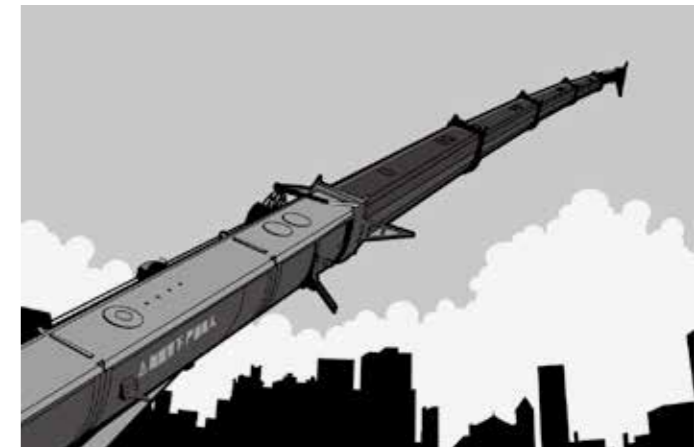

Ultra strong, super long and sensitive lifting performance

It leads the industry with longest boom length of 97m and lifting height of 97.5m. Max. lifting capacity of 180t ensures the super strong lifting capacity. 0°~40° automatical infinite variable luffing jib is applied to ensure conveniently switching over between all operating conditions with high operation efficiency.



Highly efficient, energy-saving and original hydraulic control technology

Self-developed dual-pump converging/diversion main valve is used. Converging flow of the single-action dual-pump can be up to 520L/min, ensuring fast operation and high work efficiency. Combined-action dual-pump diversion system is applied to ensure stable controllability with independent oil supply achieved for reliable operation. Electric proportional variable displacement piston pump is used to ensure accurate flow control which is efficient and energy saving.





Safe, stable, advanced and intelligent electronic control technology

The adoption of internationally advanced distributed integration bus data communication network and the configuration of complete set of sensing elements can achieve timely feedback of data information and monitor the overall working status in real-time. The human-computer interaction interface is used to meet customer's individual requirements.

Superstructure

-  **Cab**
- It is made of safety glass and anti-corrosion steel plate with ergonomic design such as full-coverage soften interior, panoramic sunroof and adjustable seats etc., and humanized design provides more comfortable and relaxing operation experience. The display of load moment limiter integrates main console and operation display system, which clearly show the data of all operating superstructure conditions of lifting operation.

-  **Engine**
- Type: Inline six-cylinder, water cooled, supercharged and inter-cooling diesel engine
 - Rated power: 170kw/2200r/min
 - Environment-protection: Emission complies with EuroIII standard
 - Capacity of fuel tank: 260L

-  **Hydraulic system**
- The adoption of high-quality main oil pump, slewing pump, main valve, winch motor and balance valve etc. key hydraulic parts ensure high stability and reliability of the system. Accurate parameter matching provides more excellent operation performance. The electric proportional variable displacement piston pump is used to adjust the pump displacement in real-time through the change of the opening of the electrical control handle, thus achieving high-precision flow control with no-loss of energy during operation. Self-developed dual-pump converging / diversion main valve is used with single action dual-pump applied to ensure high converging efficiency and combined action dual-pump diversion applied to ensure good controllability.
 - The use of dead-weight luffing compensation hydraulic system ensures excellent lowering micro-mobility and stability.
 - Single-cylinder pin telescopic system is used for boom.
 - Jib is equipped with luffing cylinder to achieve 0°~ 40°infinitely luffing.
 - Closed slewing system is used with flow and direction changed through adjusting the angle of the swash plate of the variable pump, thus ensuring excellent micro-mobility and stable rotation.
 - Capacity of hydraulic oil tank: 1025L.

-  **Control system**
- SYMC load moment limiter system developed by SANY can electrically control (PLC control) the crane. Two multi-directional handles can reset automatically, the crane movement can be adjusted through hydraulic pump and its speed can be controlled through regulating the engine speed.

-  **Luffing system**
- Dead-weight luffing features higher energy saving capacity is applied. The use of single cylinder and arrangement of front hinge ensure easy luffing operation and reduce stress on the lifting boom. The electric proportional controlled balance valve is used. Luffing angle: 0°~ 82°.

-  **Telescopic system**
- Six-section boom is applied with basic boom length of 13.5m and fully extended boom lifting height of 62m respectively. Max. lifting height is 97.5m including jib. It is made of fine grain high-strength steel with U-shaped section and telescopic operation driven independently by hydraulic system.

-  **Slewing system**
- 360°rotation is applied with Max. slewing speed up to 1.8r/min. One closed proportional variable pump and two axial constant-displacement plunger hydraulic motor are used. The use of electric proportional closed hydraulic circuit and electric proportional pedal can achieve emergency brake.

Superstructure

-  **Hoisting system**
- Main winch adopts the electric proportional variable motor, providing good micro-mobility and stability of the winch and achieving infinitely variable speed. The use of self-developed closed slewing buffer system can ensure more stable rotation starting and braking process and excellent micro-mobility. Diameter of wire ropes of main and auxiliary winches is 22mm and length is 280m.

-  **Safety system**
- Load moment limiter: With analytical mechanics method, the load moment limiter calculation system is established based on the load mechanical model. Therefore, the rated hoisting accuracy can be up to ±3% through on-line non-load calibration, protecting the hoisting operation in all aspects. In case of overload operation, system will issue an alarm automatically to provide safety guarantee for operation.
 - Hydraulic system is configured with the balance valve, overflow valve and two-way hydraulic lock etc. components, thus achieving stable and reliable operation of the hydraulic system.
 - Main and auxiliary winches are configured with 3-wraps protectors to prevent over roll-out of wire rope.
 - Boom and jib are configured with height limiters at ends to prevent over-hoist of the wire rope.
 - Boom head is equipped with anemometer to detect whether the high-altitude wind speed is out of the allowable range.

-  **Counterweight**
- Combined variable counterweights are used with 0t, 10t, 19t, 28t, 37t, 46t, 60t seven combinations. Good micro-mobility can be achieved through wireless remote control.

Chassis

-  **Driver's Cab**
- Cab is made of new steel structure self-developed by SANY, featuring excellent shock absorption and tightness, which is configured with swing-out doors at both sides, pneumatically suspended driver's seat and passenger's seat, adjustable steering wheel, large rearview mirror, comfort driver's chair with a headrest, anti-fog fan, air conditioner, stereo radio and complete control instruments and meters, providing more comfortable, safe and humanized operation experience.

-  **Carrier frame**
- Designed and manufactured by SANY, anti-torsion box structure is welded by fine-grain high-strength steel plate to provide strong load bearing capacity.

-  **Axles**
- All axles are steering axles and axles 1, 2, 4 and 5 are drive axles. Axles 1, 2, 4 and 5 are planetary transmission equipped with wheels differential locks. Axles 1 and 2 adopt the bar-feedback hydraulic power steering systems and axles 3, 4 and 5 adopt the electrohydraulic control steering system with assist in speed control and special steering mode optional, ensuring easy steering and flexible operation.

-  **Engine**
- Type: Inline eight-cylinder, water cooled, supercharged and inter-cooling diesel engine
 - Rated power: 390kw/1800r/min
 - Environment-protection: Emission complies with EuroIII standard
 - Capacity of fuel tank: 500L

Chassis



Transmission system

- Gearbox: Manual /Automatic gearbox is adopted with 12 gears and large speed ratio range, which meets the requirements of low gradeability speed and high speed traveling.
- Transfer case: Transfer case with a large input torque is used with rated torque up to 30000N.m and with differential lock air cylinder configured.
- Transmission shaft: With optimized arrangement of the transmission shaft, the transmission is more stable and reliable. For most optimized transmission, face-tooth coupling transmission shaft is used with large transmission torque.



Brakes system

- Brakes system includes traveling brake, parking brake, hydrodynamic retarder brake and auxiliary brake.
- Parking brake: Force driven by accumulator is applied on the second to fifth axle.
- Traveling brake: All wheels use the air servo brakes and dual-circuit brake system and are equipped with drum brakes.
- Auxiliary brake: Engine is equipped with engine brake and exhaust brake to reduce crane speed in advance, reducing wear on the braking parts and saving cost significantly.



Suspension system

- Axle suspension devices adopt the height-adjustable oil-gas suspension devices equipped with the hydraulic lock, with suspension height changed within $\pm 150\text{mm}$ to achieve suspension, rigid locking, automatic leveling, overall lifting and lowering, single-point lifting and lowering modes. With good trafficability and adaptability of a variety of operating conditions and road conditions, traveling smoothness, comfort ability and good side stability can be achieved. The increasing of the crane drive force can be achieved through lifting the third axle to adapt to the snowfield and other complex road conditions etc.



Steering system

- Servo power steering gear and dual-circuit system hydraulic steering device are used with emergency steering pump equipped. Axles 3, 4 and 5 adopt the electro-hydraulic steering control with steering adjusted through regulating the speed. Axle 3 steering will stop from 30km/h and from 60km/h for axles 4 and 5.
- Six types steering modes: 1) Road running mode (default mode). 2) Full-wheel steering mode. 3) Crab-type mode. 4) Steering mode without deflection. 5) Independent rear-axle steering mode. 6) Steering mode with rear axle locked.



Outriggers

- Four-point supporting with Max. vertical and horizontal span up to 9.0m \times 8.5m, and full-hydraulic horizontal and vertical outrigger cylinder telescopic movement are applied with the automatic level adjustment function.



Electrical system

- Modern data bus system equipped with 24V DC power supply and two sets of batteries with 180AH for each set is used to cut off the power supply of undercarriage.
- Chassis adopts CAN-bus system. Multifunctional centralized display system is used. Power consumption is small with maximum value of only 5w. Four functional keys are provided on the user interface. LCD display is used with contrast adjustable.

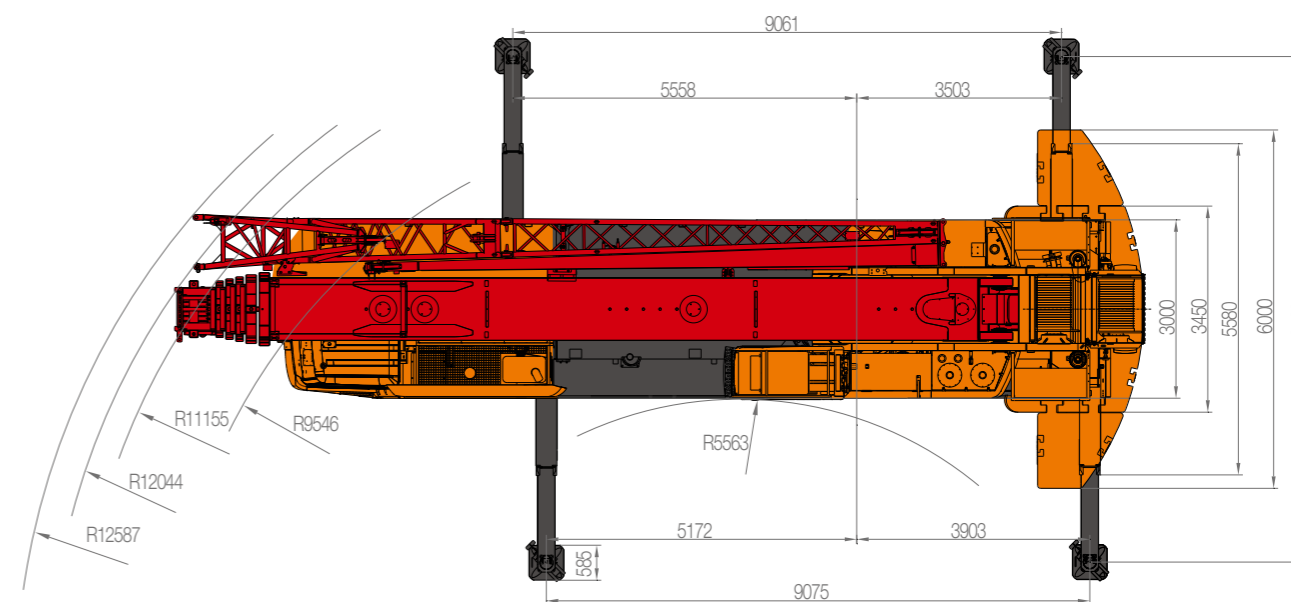
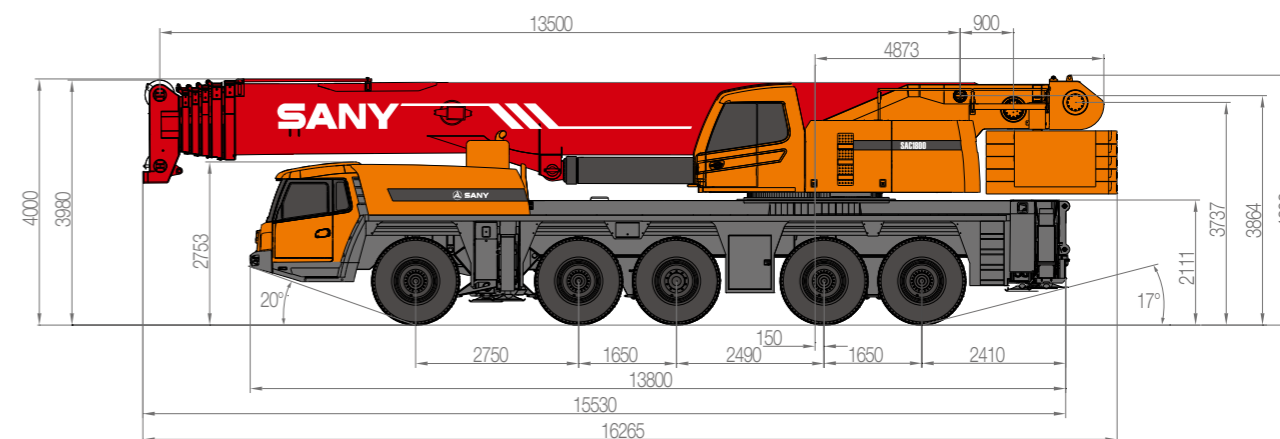

Type	Item	Parameter	
Capacity	Max. lifting capacity	180 t	
Dimensions	Overall length	15530 mm	
	Overall width	3000 mm	
	Overall height	4000 mm	
	Axle distance	Axle-1,2	2750 mm
		Axle-2,3	1650 mm
Axle-3,4		2490 mm	
Axle-4、5		1650 mm	
Weight	Overall weight	60000 kg	
	Axle load	Axle load-1,2	12000 kg
		Axle load-3,4,5	12000 kg
	Rated power	390 kW/1800 rpm	
	Rated torque	2400 N.m/ 1100 rpm	
Traveling	Max.traveling speed	81 km/h	
	Turning radius	Min.turning radius	10 m
		Min.turning radius of boom head	11 m
	Wheel formula	10 × 8	
	Min.ground clearance	325 mm	
	Approach angle	20 °	
	Departure angle	17 °	
	Max.gradeability	58%	
	Fuel consumption per 100km	≤ 72 L	
	Main Performance Data	Temperature range	- 20 °C ~ + 40 °C
Min.rated range		3 m	
Tail slewing radius of swingtable		4.75 m	
Boom section		6	
Boom shape		U-shaped	
Max.lifting moment		Base boom	6320 kN·m
		Full-extend boom	3000 kN·m
		Full-extend boom+jib	575 kN·m
Boom length		Base boom	13.5 m
		Full-extend boom	62 m
	Full-extend boom+jib	97 m	
Outrigger span (Longitudinal×Transversal)	9.0 × 8.5 m		
Jib offset	0° ~ 40°		
Working speed	Max.single rope lifting speed of main winch (no load)	130 m/min	
	Max.single rope lifting speed of auxiliary winch (no load)	130 m/min	
	Full extension/retraction time of boom	550 / 550 s	
	Full lifting/descending time of boom	60 / 90 s	
	Slewing speed	1.8 r/min	
Aircondition	Aircondition in up cab	Heating/Cooling	
	Aircondition in low cab	Heating/Cooling	

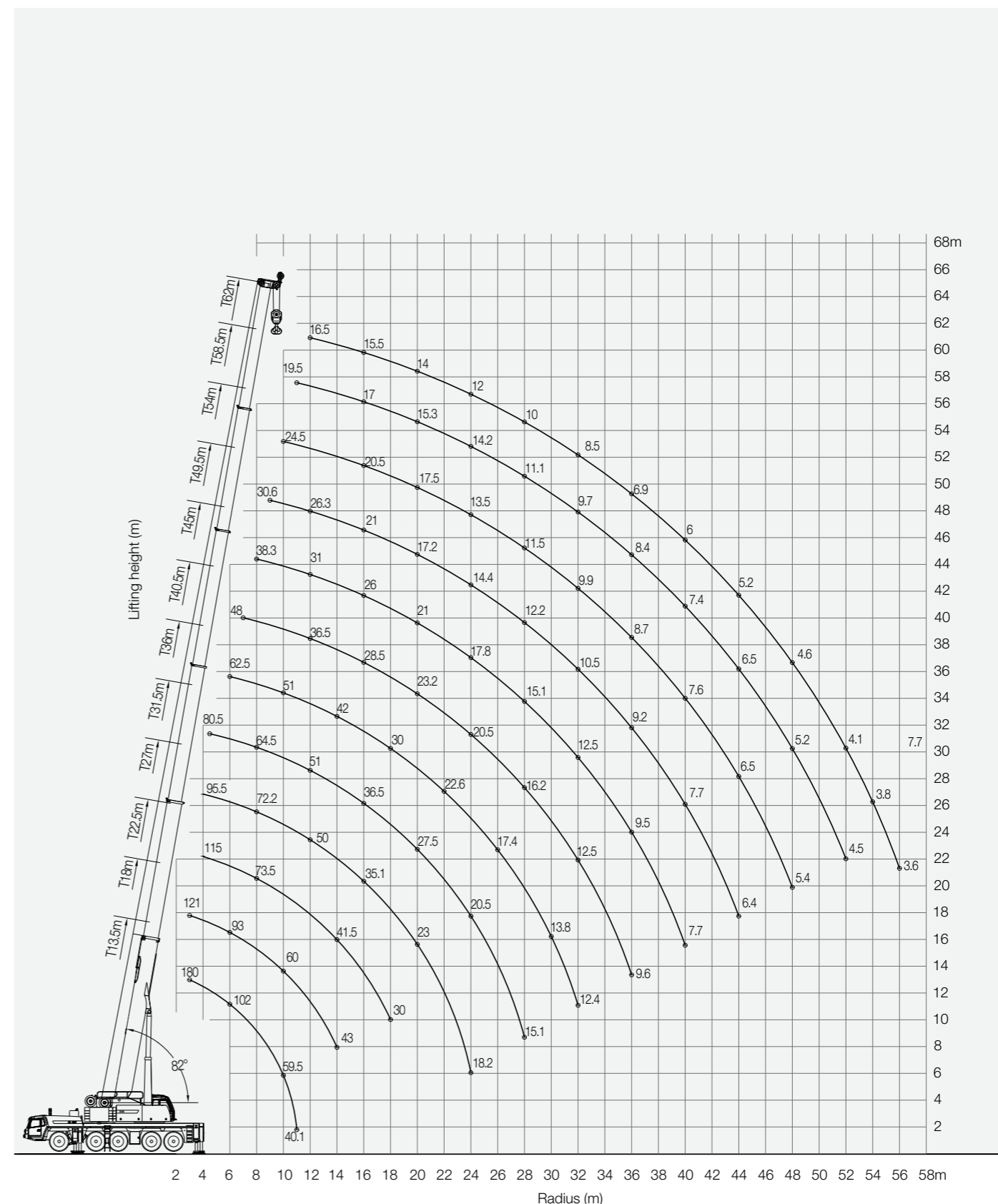

Prerequisites:
 ① Boom operating conditions(fully extended boom length),min length is 13.5m and max.length is 62m
 ② The span of outriggers is 9.0m×8.5m
 ③ 360°rotation is applied
 ④ Counterweight is 0T

Working range (m)	Main boom												Working range (m)
	13.50	18.00	22.50	27.00	31.50	36.00	40.50	45.00	49.50	54.00	58.50	62.00	
3	140.50												3
3.5	126.00	118.00											3.5
4	113.00	111.50	97.00	83.00									4
4.5	101.00	95.50	79.50	70.00	62.00								4.5
5	90.50	78.50	67.00	60.00	56.50								5
6	63.50	59.00	55.50	49.50	44.50	43.90							6
7	47.50	44.00	42.00	39.00	36.00	37.50	31.30						7
8	35.00	32.50	34.70	30.10	29.00	29.10	25.20	24.10					8
9	26.00	25.50	27.40	24.40	23.70	23.50	20.90	20.50	18.00				9
10	20.50	21.40	20.20	20.00	19.50	19.40	17.60	17.80	15.40	13.70			10
11	15.00	17.80	17.50	17.00	18.20	16.20	15.00	15.60	14.00	11.90	10.40		11
12		14.80	13.70	14.00	14.30	13.80	13.00	13.80	12.00	10.40	9.30	8.30	12
14		9.60	8.40	10.00	10.20	10.10	9.80	10.90	9.50	8.00	7.60	6.70	14
16			4.80	5.90	7.50	7.50	7.40	8.70	7.50	6.20	5.40	5.40	16
18			2.30	3.30	5.50	5.50	5.60	8.70	6.70	4.80	4.40	4.00	18
20				1.30	2.40	3.90	4.20	5.00	5.10	3.60	3.30	2.50	20
22						2.70	3.00	3.60	3.70	2.60	2.20	1.50	22
24						1.60	2.00	2.40	2.60	1.70	1.50	1.00	24
26							1.20	1.40	1.60	1.30	1.00	0.80	26
28													28
30													30
32													32
34													34
36													36
38													38
40													40
42													42
44													44
46													46
48													48
50													50
52													52
54													54
56													56
58													58
Number of line	14	14	14	13	9	5	4	3	2	2	2	1	Number of line

Prerequisites:
 ① Boom operating conditions(fully extended boom length),min length is 13.5m and max.length is 62m
 ② The span of outriggers is 9.0m×8.5m
 ③ 360°rotation is applied
 ④ Counterweight is 10T

Working range (m)	Main boom												Working range (m)
	13.5	18	22.5	27	31.5	36	40.5	45	49.5	54	58.5	62	
3	150.0												3
3.5	140.0	121.0											3.5
4	126.6	115.0	111.0	95.0									4
4.5	110.8	105.5	104.5	93.5	76.5								4.5
5	99.0	95.5	91.5	82.0	73.5								5
6	81.0	79.0	69.0	63.0	58.5	55.5							6
7	69.0	62.5	58.5	54.0	51.0	46.5	43.0						7
8	55.1	49.0	48.2	45.0	42.3	40.5	36.5	29.5					8
9	42.0	40.0	38.6	35.5	36.0	34.5	31.8	27.4	26.5				9
10	33.2	33.9	31.8	30.2	30.5	30.5	27.4	25.9	22.9	19.9			10
11	27.0	26.0	26.7	26.4	26.2	26.1	24.9	22.6	20.3	17.6	15.4		11
12		20.0	23.5	22.6	24.5	23.0	21.1	20.1	18.2	16.1	13.1	12.0	12
14		15.5	16.3	17.1	18.8	18.7	16.8	16.2	14.8	13.3	11.5	10.3	14
16			12.0	12.8	14.5	15.1	13.7	13.3	12.3	11.1	9.6	8.7	16
18			8.5	9.3	11.5	11.4	11.3	11.1	10.3	9.3	8.1	7.3	18
20			6.2	6.6	8.8	9.7	9.3	9.4	8.7	7.9	6.8	6.2	20
22				4.6	6.7	6.7	7.3	7.8	7.5	6.8	5.6	5.3	22
24				3.1	5.0	5.4	5.0	6.3	6.3	5.8	4.6	4.5	24
26					3.5	4.6	3.4	5.0	5.0	4.9	3.7	3.8	26
28					1.5	3.4	2.2	3.8	3.9	3.9	3.0	3.2	28
30						2.4	1.2	2.9	3.0	3.0	2.1	2.5	30
32								2.0	2.2	2.2	1.5	2.0	32
34								1.2	1.4	1.4	1.2	1.3	34
36													36
38													38
40													40
42													42
44													44
46													46
48													48
50													50
52													52
54													54
56													56
58													58
Number of line	14	14	14	13	10	8	5	4	3	3	2	2	Number of line

Prerequisites:
 ① Boom operating conditions(fully extended boom length),min length is 13.5m and max.length is 62m
 ② The span of outriggers is 9.0m×8.5m
 ③ 360°rotation is applied
 ④ Counterweight is 19T

Working range (m)	Main boom												Working range (m)
	13.5	18	22.5	27	31.5	36	40.5	45	49.5	54	58.5	62	
3	180.0 *												3
3.5	137.8	120.5											3.5
4	129.0	114.5	114.1	95.5									4
4.5	110.5	105.5	104.5	93.5	77.0								4.5
5	98.0	95.5	91.5	85.5	73.5								5
6	82.5	80.5	80.5	77.0	58.5	56.0							6
7	70.5	71.0	70.0	67.0	60.8	51.0	44.0						7
8	62.5	61.2	58.0	56.4	56.6	48.5	39.5	36.5					8
9	50.6	48.5	46.0	43.5	41.8	36.0	33.5	31.5	27.9				9
10	40.5	39.1	37.3	37.4	35.0	32.5	30.6	28.4	26.1	22.7			10
11	33.8	32.3	31.2	34.5	33.0	29.7	27.6	27.1	24.5	21.7	16.0		11
12		30.4	28.6	31.5	30.5	25.9	24.8	24.5	22.2	20.4	16.1	12.0	12
14		23.8	24.2	22.5	23.3	21.6	19.2	18.3	18.4	17.0	14.1	12.0	14
16			18.0	17.8	17.3	17.0	16.7	15.2	14.3	13.5	11.9	16	
18			14.5	14.7	14.3	13.8	14.1	13.7	13.2	12.2	10.9	10.3	18
20			10.8	11.2	11.9	11.5	10.9	10.6	11.3	10.4	9.2	9.0	20
22				9.1	8.8	9.5	9.0	8.8	9.7	8.8	8.4	8.0	22
24				6.6	7.5	7.8	7.4	7.3	8.2	7.5	7.3	6.5	24
26					6.2	6.4	6.1	6.0	7.0	6.3	6.0	5.5	26
28					4.7	5.2	4.9	4.9	6.0	5.3	5.3	4.8	28
30						4.2	3.9	4.0	5.0	4.4	4.3	3.8	30
32						3.4	3.0	3.0	4.2	3.6	3.5	3.0	32
34							2.2	2.2	3.5	2.8	2.2	2.2	34
36							1.5	1.5	2.9	2.1	1.8	1.7	36
38									2.2	1.4	1.3	1.0	38
40									1.7		1.0	0.5	40
42									1.1				42
44													44
46													46
48													48
50													50
52													52
54													54
56													56
58													58
Number of line	14	14	14	14	11	8	5	4	4	3	2	2	Number of line

Notes: The item with * should be operated at rear side with additional equipment.

Prerequisites:
 ① Boom operating conditions(fully extended boom length),min length is 13.5m and max.length is 62m
 ② The span of outriggers is 9.0m×8.5m
 ③ 360°rotation is applied
 ④ Counterweight is 28T

Working range (m)	Main boom												Working range (m)	
	13.5	18	22.5	27	31.5	36	40.5	45	49.5	54	58.5	62		
3	180.0 *												3	
3.5	137.8	121.0											3.5	
4	129.0	115.5	114.1	96.0									4	
4.5	112.5	108.0	107.3	94.0	78.0								4.5	
5	101.0	98.5	97.5	89.0	74.0								5	
6	87.0	85.5	86.0	80.0	63.5	58.5							6	
7	75.5	76.0	75.1	69.4	63.0	54.5	46.9						7	
8	66.0	66.0	65.0	61.1	60.0	53.0	42.9	38.0					8	
9	55.5	56.0	55.0	52.2	51.0	45.0	39.0	34.5	30.6				9	
10	46.5	46.5	46.1	44.4	43.4	40.0	36.0	32.0	29.7	25.0			10	
11	35.0	41.5	39.4	37.5	38.1	36.8	33.1	30.7	27.8	23.7	20.0		11	
12		35.8	35.6	32.2	34.2	32.1	30.0	28.4	26.0	22.7	19.0	14.0	12	
14		28.0	28.0	24.6	26.9	26.2	24.2	22.5	21.2	20.3	18.0	13.5	14	
16			21.5	19.5	20.9	21.3	20.0	19.2	17.8	17.2	16.0	12.9	16	
18			17.5	15.9	17.4	17.9	16.9	16.4	15.6	14.8	14.6	11.9	18	
20			13.1	13.2	14.7	15.2	13.5	13.5	13.0	13.0	12.7	11.9	20	
22				11.0	12.5	12.5	11.5	11.2	11.2	11.1	11.2	10.7	22	
24					9.3	10.5	10.8	9.8	10.0	9.7	9.7	9.8	9.5	24
26						9.0	9.5	8.4	8.5	8.3	8.4	8.6	8.0	26
28							7.1	8.0	7.1	7.0	7.2	7.3	7.0	28
30								7.0	6.1	6.0	6.2	6.4	6.3	30
32								5.6	5.2	5.5	5.3	5.5	5.3	32
34									4.4	4.7	4.5	4.7	4.5	34
36									3.7	3.5	3.8	4.0	3.8	36
38										2.8	3.0	3.4	3.2	38
40										2.2	2.4	2.7	2.2	40
42										1.7	1.8	2.1	1.6	42
44											1.2	1.5	1.5	44
46												1	1.2	46
48													1	48
50														50
52														52
54														54
56														56
58														58
Number of line	14	14	14	14	11	8	5	4	4	1	2	2	Number of line	

Notes: The item with * should be operated at rear side with additional equipment.

Prerequisites:
 ① Boom operating conditions(fully extended boom length),min length is 13.5m and max.length is 62m
 ② The span of outriggers is 9.0m×8.5m
 ③ 360°rotation is applied
 ④ Counterweight is 37T

Working range (m)	Main boom												Working range (m)
	13.5	18	22.5	27	31.5	36	40.5	45	49.5	54	58.5	62	
3	148.0												3
3.5	140.0	120.5											3.5
4	129.0	115.5	114.1	95.5									4
4.5	116.0	110.5	107.3	93.5	78.5								4.5
5	103.0	102.0	101.4	91.5	74.5								5
6	91.0	90.5	91.0	84.5	69.0	60.5							6
7	81.0	80.5	78.9	76.9	65.0	66.5	46.9						7
8	69.0	70.5	69.2	64.2	62.9	56.5	42.9	38.3					8
9	61.0	62.8	61.4	57.3	56.3	53.5	39.7	35.3	30.6				9
10	53.0	53.0	52.5	51.2	50.3	47.0	36.8	32.9	29.7	25.5			10
11	35.0	46.0	47.3	44.5	44.0	43.4	34.5	30.7	27.8	24.5	19.0		11
12		42.7	41.1	39.0	38.8	38.5	32.3	28.8	26.3	23.5	18.0	15.5	12
14		32.6	31.3	30.2	30.3	30.4	28.2	25.6	23.4	21.7	17.1	15.0	14
16			24.6	25.1	24.4	24.7	23.1	22.3	21.0	19.4	16.5	14.5	16
18			19.8	20.6	20.1	20.5	19.3	18.7	18.2	17.6	16.0	14.0	18
20			16.5	17.2	16.7	17.2	16.3	15.9	15.6	15.3	15.1	13.5	20
22				14.6	14.1	14.6	13.9	13.6	13.4	13.3	13.3	12.9	22
24				12.8	12.0	12.5	12.0	11.8	11.7	11.7	11.7	11.2	24
26					10.4	10.9	10.4	10.3	10.3	10.3	10.4	10.2	26
28					9.1	9.5	9.1	9.0	9.0	9.1	9.3	9.2	28
30						8.3	7.9	7.8	7.9	8.0	8.3	8.2	30
32						7.3	6.9	6.8	6.9	7.1	7.4	7.3	32
34							6.0	5.9	6.0	6.2	6.5	6.5	34
36							5.3	5.1	5.2	5.4	5.8	5.8	36
38								4.5	4.5	4.8	5.1	5.2	38
40								3.8	3.9	4.1	4.5	4.5	40
42								3.3	3.3	3.6	3.9	4.0	42
44									2.7	3.0	3.4	3.5	44
46									2.3	2.4	2.9	2.9	46
48										2.0	2.4	2.4	48
50										1.6	1.9	2.0	50
52											1.6	1.6	52
54											1.2	1.2	54
56													56
58													58
Number of line	14	14	14	14	12	8	5	4	4	3	2	2	Number of line

Prerequisites:
 ① Boom operating conditions(fully extended boom length),min length is 13.5m and max.length is 62m
 ② The span of outriggers is 9.0m×8.5m
 ③ 360°rotation is applied
 ④ Counterweight is 46T

Working range (m)	Main boom												Working range (m)
	13.5	18	22.5	27	31.5	36	40.5	45	49.5	54	58.5	62	
3	148.0												3
3.5	137.8	116.0											3.5
4	126.0	114.0	114.1	93.0									4
4.5	119.0	108.5	107.3	92.5	76.5								4.5
5	112.8	104.5	101.4	90.5	70.5								5
6	99.9	91.0	91.3	85.9	65.0	60.5							6
7	88.7	80.8	82.8	76.4	64.0	56.5	46.9						7
8	77.3	71.9	72.5	67.3	62.5	54.0	42.9	38.3					8
9	68.3	62.4	64.4	60.0	59.1	52.5	39.7	35.3	28.4				9
10	56.5	56.4	57.7	54.0	53.3	50.7	36.8	32.9	27.4	22.3			10
11	38.1	53.6	52.2	49.0	48.5	48.1	34.5	30.7	24.8	22.0	17.0		11
12		48.6	47.2	44.5	44.1	43.7	32.3	28.8	22.3	21.7	16.5	13.0	12
14		36.8	37.2	35.5	35.4	35.4	28.5	25.6	20.4	20.7	16.2	12.7	14
16			29.7	28.8	28.9	29.1	25.5	22.9	18.0	18.5	16.0	12.5	16
18			24.3	23.7	24.0	24.3	22.9	20.7	16.5	16.6	15.0	12.0	18
20			17.5	19.8	20.2	20.6	19.7	18.7	14.5	14.5	14.3	11.5	20
22				16.8	17.2	17.7	16.9	16.6	13.5	13.5	13.0	11.0	22
24				14.6	14.8	15.3	14.7	14.4	12.3	12.0	12.0	10.7	24
26					12.8	13.3	12.8	12.6	11.5	11.5	11.0	10.2	26
28					11.3	11.6	11.2	11.0	11.0	10.5	10.0	9.4	28
30						10.2	9.8	9.7	9.7	9.8	9.5	8.7	30
32						9.1	8.6	8.5	8.6	8.7	9.0	8.0	32
34							7.6	7.5	7.6	7.7	8.0	7.4	34
36							6.8	6.6	6.7	6.8	7.2	6.9	36
38								5.9	5.9	6.1	6.4	6.4	38
40								5.2	5.2	5.4	5.7	5.8	40
42								4.7	4.6	4.8	5.1	5.2	42
44									4.1	4.2	4.6	4.7	44
46									3.7	3.7	4.1	4.1	46
48										3.3	3.6	3.6	48
50										2.9	3.1	3.1	50
52											2.7	2.7	52
54											2.4	2.3	54
56												1.9	56
58												1.7	58
Number of lineRatio	14	14	14	14	12	8	5	4	4	3	2	2	Number of line

Prerequisites:
 ① Boom operating conditions (fully extended boom length), min length is 13.5m and max. length is 62m
 ② The span of outriggers is 9.0m×8.5m
 ③ 360° rotation is applied
 ④ Counterweight is 60T

Working range (m)	Main boom												Working range (m)
	13.5	18	22.5	27	31.5	36	40.5	45	49.5	54	58.5	62	
3	180 *												3
3.5	141	121											3.5
4	129	117	115	95.5									4
4.5	120.4	111	112	95	80.5								4.5
5	115.1	106	104	92.5	75.5								5
6	102	93	91.4	88.5	70	62.5							6
7	89	83	82	82.5	65.5	58.5	48						7
8	80	74	73.5	72.2	64.5	57.5	45	38.3					8
9	72.3	66	65.5	65	63.4	54.5	43	36.3	30.6				9
10	59.5	60	59.5	58.1	59.5	51	41	33.9	29.7	24.5			10
11	40.1	57.7	55	52.7	53.5	50	38.5	31.7	27.8	24	19		11
12		51	50.5	50	51	48	36.5	31	26.3	23.5	18	16.5	12
14		43	41.5	40.8	43	42	32	29	23.4	22.5	17.5	16	14
16			35.5	35.1	36.5	36.5	28.5	26	21	20.5	17	15.5	16
18			30	29.6	31.5	30	25.5	23.5	18.9	18.6	16	15	18
20			17.5	23	27.5	25.9	23.2	21	17.2	17.5	15.3	14	20
22				20	24	22.6	21.1	19.5	15.7	15.7	14.8	13	22
24				18.2	20.5	19.7	20.5	17.8	14.4	13.5	14.2	12	24
26					18	17.4	18.4	16.3	13.3	12.5	13.7	11	26
28					15.1	15.4	16.2	15.1	12.2	11.5	11.1	10	28
30						13.8	14.2	14	11.3	10.7	10.4	9.8	30
32						12.4	12.5	12.5	10.5	9.9	9.7	8.5	32
34							11.2	10.5	9.8	9.3	9	7.4	34
36							9.6	9.5	9.2	8.7	8.4	6.9	36
38								8.5	8.6	8.1	7.9	6.4	38
40								7.7	7.7	7.6	7.4	6	40
42								7.2	7	7.1	6.9	5.6	42
44									6.4	6.5	6.5	5.2	44
46									5.8	5.9	5.8	4.9	46
48										5.4	5.2	4.6	48
50										4.9	4.8	4.3	50
52											4.5	4.1	52
54											4.3	3.8	54
56												3.6	56
58												3.4	58
60													60
Number of line	14	14	14	14	12	8	5	4	4	3	2	2	Number of line

Notes: The item with * should be operated at rear side with additional equipment.

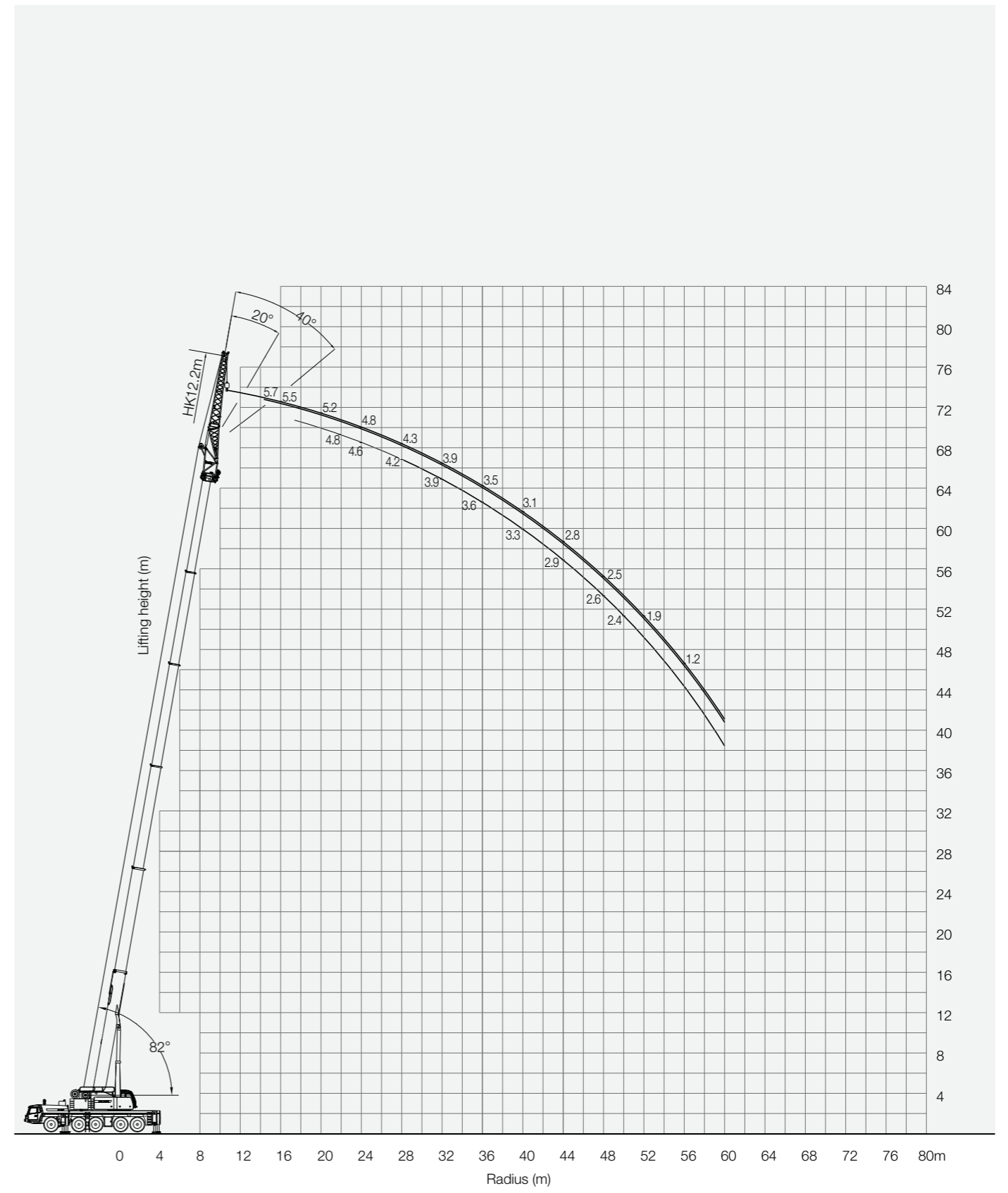

- Prerequisites:**
- ① Boom operating conditions (fully extended boom length+ jib length), max.length is 62m+12.2m
 - ② The span of outriggers is 9.0m×8.5m
 - ③ 360° rotation is applied
 - ④ Counterweight is 60T

Working range (m)	Main boom +Jib																								Working range (m)			
	13.5			31.5			36			40.5			45			49.5			54			58.5				62		
	0°	20°	40°	0°	20°	40°	0°	20°	40°	0°	20°	40°	0°	20°	40°	0°	20°	40°	0°	20°	40°	0°	20°	40°		0°	20°	40°
3	17.5																										3	
3.5	17.5																											3.5
4	17.5																											4
4.5	17.5																											4.5
5	17.5																											5
6	17.5	15.8		17.5			17.5																					6
7	17.5	14.6		17.5			17.5																					7
8	17.5	13.5		17.5			17.5			17.5																		8
9	17.5	12.6		17.5			17.5			17.5			15.3															9
10	17.5	11.8	8.8	17.5	13		17.5			17.5			15.2			12.5												10
11	15.7	11.1	8.8	17.5	12.5		17.5	12.6		17.2			15.2			12.3			9.9									11
12	14.5	10.5	8.8	17.1	12		17.5	12.1		16.6	12		14.8			12.1			9.7			7.2						12
14	12.3	9.4	8.6	15.5	11.2	8.8	15.8	11.3	8.8	15.5	11.2		14	10.9		11.6			9.4			7			5.7			14
16	10.7	8.6	8.1	13.9	10.5	8.8	14.5	10.7	8.8	14.3	10.6	8.8	13.1	10.3		11	9.8		8.9	8.2		6.8			5.5			16
18	9.4	7.9	7.9	12.6	9.9	8.5	13.3	10.1	8.6	13.3	10.1	8.6	12.1	9.8	8.5	10.3	9.4	8.2	8.5	7.7		6.5	6.2		5.4			18
20	8.3	7.4		11.6	9.3	8.3	12.2	9.6	8.4	12.4	9.6	8.3	11.2	9.4	8.2	9.5	8	8	7.2	7		6.1	5.8		5.2	5		20
22	7.4	7.1		10.6	8.8	8	11.3	9.1	8.1	11.4	9.2	8.2	10.3	9	8.1	8.8	8.5	7.8	7.5	6.8	6.6	5.8	5.5	5.4	5	4.8	4.8	22
24				9.8	8.3	7.7	10.4	8.6	7.9	10.7	8.8	7.9	9.4	8.7	7.8	8.2	8	7.6	7	6.4	6.2	5.5	5.2	5.2	4.8	4.6	4.6	24
26				9.1	7.8	7.4	9.7	8.2	7.6	10.1	8.4	7.7	8.7	8.3	7.6	7.6	7.5	7.2	6.5	6.1	5.9	5.2	5	5	4.5	4.4	4.4	26
28				8.5	7.4	7.1	9.1	7.8	7.3	9.1	8	7.4	8.1	7.9	7.4	7	6.9	6.8	6.1	5.7	5.6	5	4.7	4.7	4.3	4.2	4.2	28
30				8	7.1	6.9	8.5	7.4	7.1	8.2	7.6	7.2	7.4	7.3	7.1	6.4	6.4	6.4	5.6	5.4	5.3	4.7	4.5	4.5	4.1	4	4.1	30
32				7	6.7	6.6	7.6	7.1	6.8	7.3	7.3	7	6.7	6.8	6.7	5.9	6	6	5.2	5.1	5.1	4.5	4.3	4.3	3.9	3.9	3.9	32
34				7	6.4		6.7	6.8	6.6	6.4	6.8	6.7	5.8	6.3	6.3	5.4	5.5	5.6	4.8	4.8	4.8	4.2	4.1	4.2	3.7	3.7	3.7	34
36				6.6	6.2		6	6.3	6.5	5.6	6	6.3	5.4	5.5	5.8	5.1	5.1	5.2	4.5	4.5	4.6	4	4	4	3.5	3.5	3.6	36
38				5.9	6		5.4	5.6		5.1	5.4	5.5	5	5	5.2	4.6	4.8	4.8	4.1	4.2	4.3	3.8	3.8	3.8	3.3	3.4	3.4	38
40				5.4			4.9	5.1		4.6	4.8	4.9	4.5	4.7	4.7	4.1	4.4	4.5	3.9	4	4.1	3.6	3.6	3.7	3.1	3.2	3.3	40
42							4.5	4.6		4.1	4.3	4.2	4	4.3	4.4	3.8	3.9	4.1	3.6	3.7	3.8	3.4	3.4	3.5	3	3	3.1	42
44							4.1			3.7	3.9	3.7	3.6	3.9	4.1	3.6	3.6	3.6	3.3	3.5	3.6	3.2	3.2	3.3	2.8	2.9	2.9	44
46										3.3	3.5		3.3	3.5	3.8	3.3	3.4	3.5	3	3.2	3.3	3	3.1	3.1	2.6	2.7	2.8	46
48										2.9			2.8	3.1	3.5	2.9	3.2	3.2	2.8	2.9	2.9	2.7	2.9	2.9	2.5	2.5	2.6	48
50													2.4	2.6		2.5	2.7	3	2.7	2.7	2.8	2.3	2.6	2.8	2.2	2.4	2.4	50
52													2.1	2.2		2.3	2.4	2.5	2.4	2.6	2.7	1.9	2.2	2.4	1.9	2.2		52
54																2.2	2.2		2.1	2.3	2.5	1.6	1.9	2	1.5	1.8		54
56																2	2.1		1.7	1.9	2.3	1.3	1.5		1.2	1.5		56
58																1.8			1.5	1.6		1	1.2		1.2			58
60																			1.2	1.3								60
Number of line	2	2	1	2	2	1	2	2	1	2	2	1	2	2	1	2	2	1	2	1	1	1	1	1	1	1	1	Number of line

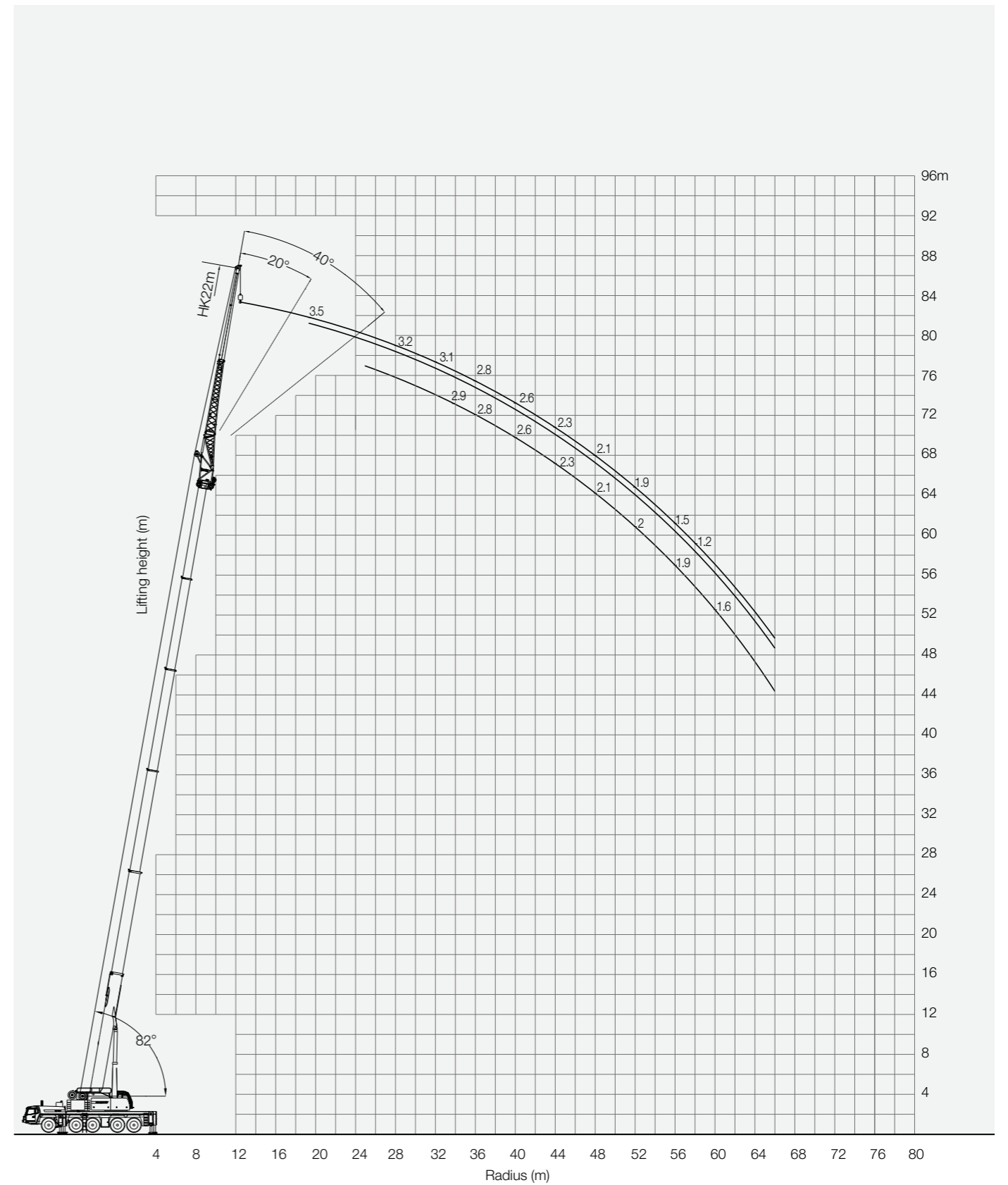

- Prerequisites:**
- ① Boom operating conditions (fully extended boom length+ jib length), max.length is 62m+22m
 - ② The span of outriggers is 9.0m×8.5m
 - ③ 360° rotation is applied
 - ④ Counterweight is 60T

Working range (m)	Main boom +Jib																								Working range (m)				
	13.5			31.5			36			40.5			45			49.5			54			58.5				62			
	0°	20°	40°	0°	20°	40°	0°	20°	40°	0°	20°	40°	0°	20°	40°	0°	20°	40°	0°	20°	40°	0°	20°	40°		0°	20°	40°	
3																												3	
3.5	11.7																											3.5	
4	11.7																											4	
4.5	11.7																											4.5	
5	11.5																											5	
6	11.2																											6	
7	10.9			8.7			8.2																					7	
8	10.5			8.7			8.2																					8	
9	10.1			8.6			8.2			7.5																		9	
10	9.7			8.5			8.1			7.5		6.8																10	
11	9.3			8.5			8.1			7.5		6.8		5.9														11	
12	8.9	7.4		8.4			8			7.5		6.7		5.9														12	
14	8.2	6.8		8.1			7.8			7.4		6.7		5.9		5.1		4.3										14	
16	7.4	6.3		7.8	6.4		7.6			7.2		6.7		5.9		5.1		4.2		3.6								16	
18	6.7	5.8	5	7.5	6.1		7.3	6		7	5.9		6.5		5.8		5		4.1		3.5							18	
20	6	5.3	4.7	7.2	5.8		7.1	5.8		6.8	5.7		6.4	5.5		5.8		5		4.1		3.5						20	
22	5.4	4.9	4.4	6.8	5.5	4.6	6.8	5.5	4.6	6.6	5.5		6.2	5.3		5.7	5.1	4.9		4		3.4						22	
24	4.9	4.6	4.2	6.5	5.2	4.4	6.6	5.3	4.4	6.4	5.3	4.4	6.1	5.2		5.6	4.9	4.8	4.6	3.9	3.7	3.3	3.3					24	
26	4.4	4.3	4	6.1	5	4.3	6.3	5.1	4.3	6.2	5.1	4.3	5.9	5	4.2	5.4	4.8	4.7	4.5	3.9	3.6	3.3	3.2					26	
28	4.1	4.1	3.9	5.7	4.8	4.2	5.9	4.9	4.2	6	4.9	4.2	5.7	4.8	4.1	5.2	4.7	4.1	4.6	4.4	3.8	3.5	3.2	3.1					28
30	3.8	3.9		5.4	4.6	4.1	5.6	4.7	4.1	5.7	4.7	4.1	5.6	4.7	4.1	5	4.5	4	4.4	4.2	3.9	3.7	3.4	3.3	3.1	3.3			30
32	3.5			5.1	4.4	4	5.3	4.5	4	5.4	4.6	4	5.3	4.5	4	4.8	4.4	3.9	4.2	4	3.8	3.5	3.3	3.2	3.1	2.9			32
34				4.7	4.2	3.9	5.1	4.3	3.9	5.1	4.4	3.9	5.1	4.4	3.9	4.6	4.3	3.9	4	3.8	3.8	3.4	3.1	3.1	2.9	2.8	2.9		34
36				4.5	4	3.8	4.8	4.2	3.9	4.9	4.3	3.9	4.9	4.3	3.9	4.3	4.2	3.8	3.8	3.7	3.7	3.2	3	3.1	2.8	2.6	2.8		36
38				4.3	3.9	3.8	4.5	4	3.8	4.7	4.1	3.8	4.6	4.1	3.8	4.1	4	3.8	3.6	3.5	3.5	3.1	2.9	3	2.7	2.6	2.7		38
40				4.1	3.8	3.7	4.3	3.9	3.7	4.5	4	3.8	4.4	4	3.8	3.8	3.9	3.7	3.4	3.4	3.4	2.9	2.8	2.9	2.6	2.5	2.6		40
42				3.9	3.6	3.6	4.1	3.8	3.7	4.3	3.9	3.7	4.1	3.9	3.7	3.6	3.7	3.7	3.2	3.2	3.3	2.8	2.6	2.8	2.5	2.4	2.5		42
44				3.7	3.5		4	3.7	3.6	4.1	3.7	3.6	3.7	3.8	3.7	3.4	3.6	3.6	3	3.1	3.2	2.7	2.5	2.7	2.3	2.3	2.4		44
46				3.6	3.5		3.8	3.6	3.6	3.7	3.7	3.6	3.4	3.7	3.6	3.2	3.4	3.5	2.9	3	3	2.6	2.4	2.6	2.2	2.2	2.3		46
48				3.5	3.4		3.7	3.5		3.4	3.6	3.6	3.2	3.4	3.6	2.8	3.2	3.3	2.7	2.8	2.9	2.4	2.3	2.5	2.1	2.1	2.2		48
50				3.5			3.4	3.4		3.1	3.4		3	3.1	3.3	2.6	3	3.1	2.5	2.7	2.8	2.3	2.2	2.4	2	2	2.1		50
52							3.1	3.3		2.7	3.1		2.6	2.9	3	2.4	2.6	2.9	2.1	2.5	2.6	2.2	2.1	2.3	1.9	1.9	2		52
54							2.8			2.4	2.7		2.3	2.7		2.3	2.4	2.5	2	2.3	2.5	1.9	2	2.2	1.7	1.8	2		54
56										2.1	2.3		1.9	2.3		1.9	2.2	2.3	1.9	2	2.2	1.6	1.8	2.1	1.5	1.6	1.9		56
58										1.8			1.7	1.9		1.7	2		1.7	1.9	2	1.3	1.5	2	1.2	1.4	1.7		58
60													1.4	1.6		1.5	1.7		1.5	1.8	1.8	1	1.2	1.7		1.1	1.6		60
62													1.2			1.4	1.5		1.2	1.6			1.4						62
64																1.4	1.4		1	1.3			1.1						64
66																			1.1										66
Number of line	2	1	1	1	1	1	1	1	1	1	1	1	1	1	1	1	1	1	1	1	1	1	1	1	1	1	1	1	Number of line

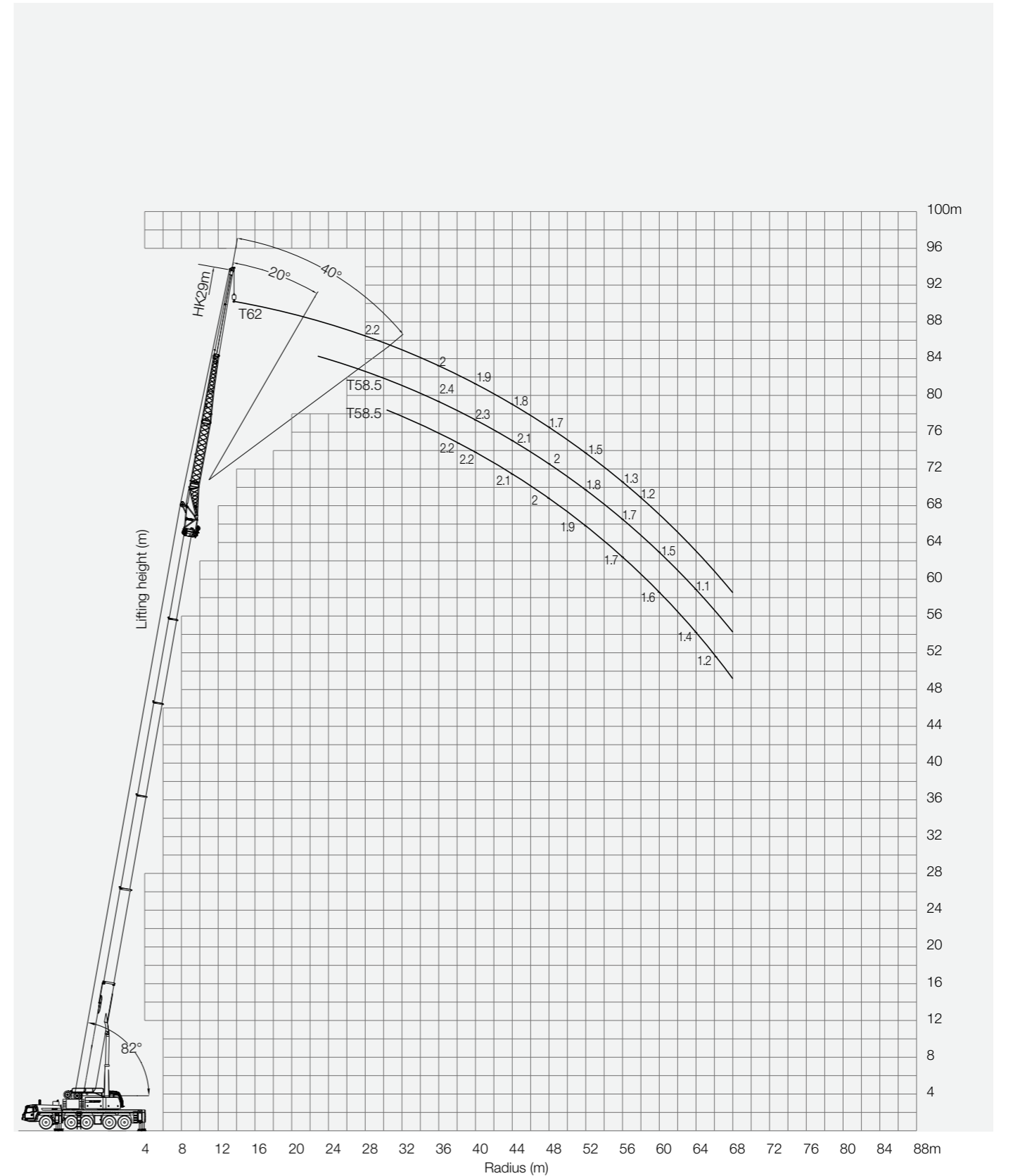

Prerequisites:

- ① Boom operating conditions (fully extended boom length+ jib length), max.length is 62m+29m
- ② The span of outriggers is 9.0m×8.5m
- ③ 360° rotation is applied
- ④ Counterweight is 60T

Working range (m)	Main boom +Jib																								Working range (m)		
	13.5			31.5			36			40.5			45			49.5			54			58.5				62	
	0°	20°	40°	0°	20°	40°	0°	20°	40°	0°	20°	40°	0°	20°	40°	0°	20°	40°	0°	20°	40°	0°	20°	40°		0°	
3																										3	
3.5																											3.5
4																											4
4.5	7.7																										4.5
5	7.7																										5
6	7.6																										6
7	7.6																										7
8	7.6				6																						8
9	7.5				6			5.6																			9
10	7.4				5.9			5.6		5.2																	10
11	7.3				5.9			5.6		5.2		4.8															11
12	7.1				5.9			5.6		5.2		4.8															12
14	6.6				5.8			5.5		5.2		4.7		4.2		3.7											14
16	6	4.9			5.7			5.4		5.1		4.7		4.2		3.6		3.1									16
18	5.6	4.6			5.5			5.3		5		4.7		4.2		3.6		3						2.5			18
20	5.1	4.3			5.3	4.3		5.2		4.9		4.6		4.2		3.6		2.9					2.4	2.0			20
22	4.6	3.9			5	4.1		5	4.1	4.8	4	4.5		4.1		3.6		2.9				2.3	2.3				22
24	4.2	3.7	3.2		4.8	3.9		4.8	3.9	4.7	3.8	4.4	3.7	4		3.6		2.8				2.3	2.3				24
26	3.8	3.4	3		4.6	3.7		4.6	3.8	4.5	3.7	4.3	3.6	4	3.4	3.5		2.8				2.2	2.2				26
28	3.5	3.2	2.9		4.4	3.6	3	4.4	3.6	4.3	3.6	4.2	3.5	3.9	3.3	3.5	3.1	2.8				2.2	2.2				28
30	3.2	3	2.7		4.2	3.4	2.9	4.2	3.5	2.9	4.2	3.4	2.9	4	3.4	3.8	3.3	3.4	3.1	2.7	2.7	2.1	2.1				30
32	2.9	2.8	2.6		4	3.3	2.8	4	3.3	2.8	4	3.3	2.8	3.9	3.3	2.8	3.7	3.2	3.4	3	2.7	2.6	2.1	2.1			32
34	2.7	2.7	2.5		3.8	3.1	2.7	3.9	3.2	2.7	3.9	3.2	2.7	3.8	3.2	2.7	3.6	3.1	2.7	3.2	2.9	2.7	2.5	2			34
36	2.5	2.6	2.5		3.6	3	2.6	3.7	3.1	2.7	3.7	3.1	2.7	3.6	3.1	2.7	3.5	3	2.6	3.1	2.9	2.5	2.6	2.4			36
38	2.4	2.5			3.4	2.9	2.6	3.6	3	2.6	3.6	3	2.6	3.5	3	2.6	3.4	2.9	2.6	3	2.8	2.5	2.5	2.4	2.2	1.9	38
40					3.2	2.8	2.5	3.4	2.9	2.6	3.5	2.9	2.6	3.4	2.9	2.5	3.2	2.8	2.5	2.9	2.7	2.5	2.4	2.3	2.2	1.9	40
42					3.1	2.7	2.5	3.2	2.8	2.5	3.3	2.8	2.5	3.3	2.8	2.5	3.1	2.8	2.5	2.8	2.6	2.4	2.3	2.2	2.1	1.8	42
44					2.9	2.6	2.5	3.1	2.7	2.5	3.2	2.7	2.5	3.2	2.7	2.5	3	2.7	2.4	2.6	2.4	2.2	2.1	2.1	2.1	1.8	44
46					2.8	2.6	2.4	3	2.6	2.4	3.1	2.7	2.4	3.1	2.7	2.4	2.9	2.6	2.4	2.5	2.4	2.1	2.1	2.1	2	1.8	46
48					2.7	2.5	2.4	2.9	2.6	2.4	3	2.6	2.4	3	2.6	2.4	2.7	2.6	2.4	2.4	2.4	2.3	2	2	2	1.7	48
50					2.6	2.4		2.7	2.5	2.4	2.9	2.5	2.4	2.7	2.5	2.4	2.5	2.5	2.4	2.2	2.3	2.3	1.9	1.9	1.9	1.6	50
52					2.5	2.4		2.6	2.4	2.4	2.7	2.5	2.4	2.5	2.5	2.4	2.2	2.4	2.4	2.1	2.2	2.2	1.8	1.8	1.9	1.5	52
54					2.4	2.3		2.5	2.4		2.5	2.4	2.4	2.4	2.4	2	2.3	2.3	1.9	2.1	2.2	1.7	1.7	1.8	1.4	54	
56					2.3			2.4	2.3		2.2	2.4	2.4	2.1	2.3	2.4	1.9	2.2	2.3	1.6	2	2.1	1.6	1.7	1.7	1.3	56
58								2.3	2.3		1.9	2.3		1.8	2.2	2.3	1.7	1.9	2.3	1.5	1.9	2	1.3	1.6	1.7	1.2	58
60								2.1	2.3		1.7	2		1.5	2	2.2	1.5	1.7	1.9	1.4	1.6	1.9	1.1	1.5	1.6		60
62											1.4	1.7		1.3	1.6		1.2	1.6	1.7	1.3	1.4	1.7		1.4	1.5		62
64											1.2	1		1	1.4		1.1	1.4	1.6	1	1.3	1.4		1.1	1.4		64
66															1.1		1	1.1				1.2	1.3		1.2		66
68																											68
Number of line	1	1	1	1	1	1	1	1	1	1	1	1	1	1	1	1	1	1	1	1	1	1	1	1	1	1	Number of line

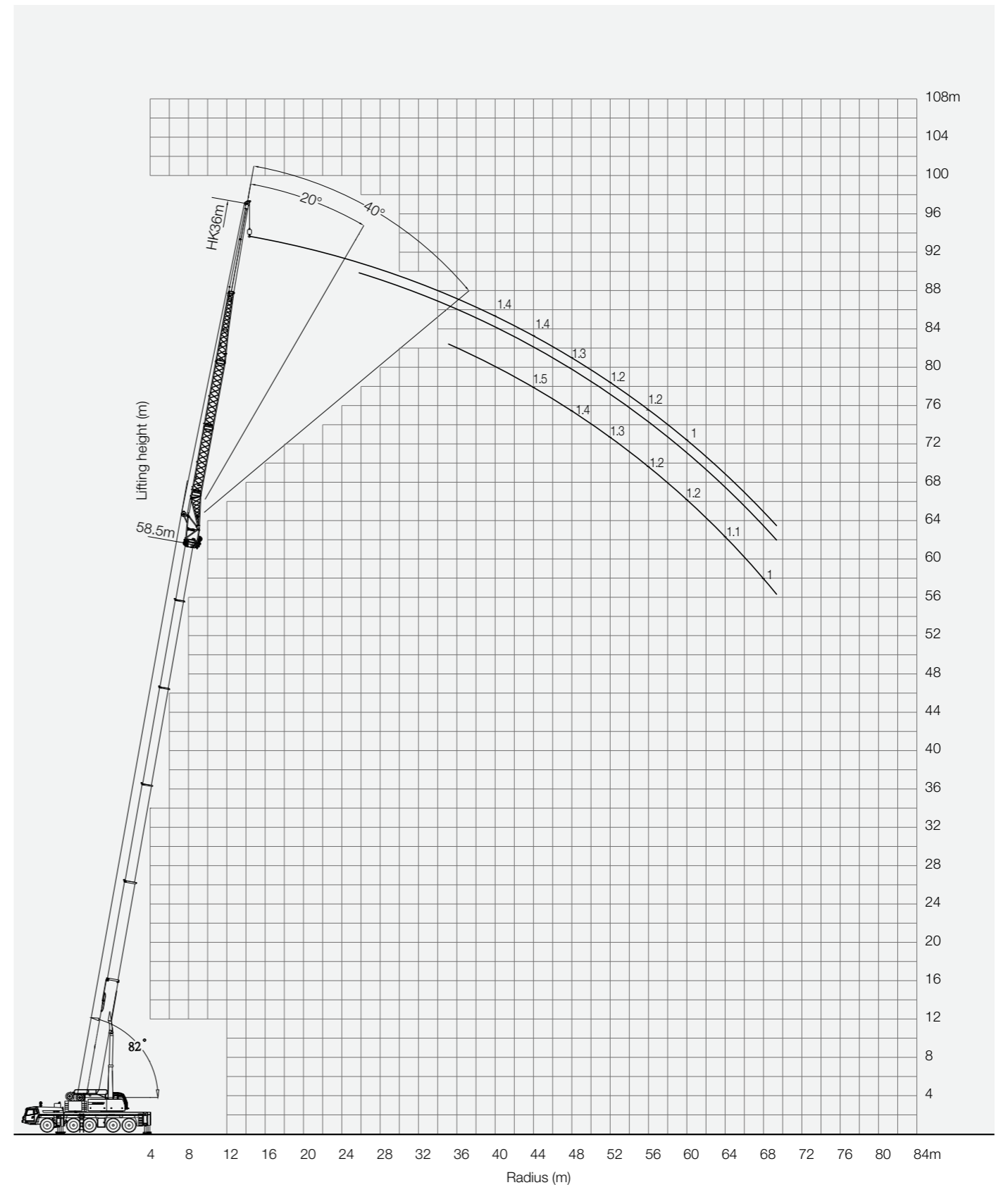

- Prerequisites:**
- ① Boom operating conditions(boom length+ jib length), max.length is 62m+36m
 - ② The span of outriggers is 9.0m×8.5m
 - ③ 360°rotation is applied
 - ④ Counterweight is 60T

Working range (m)	Main boom +Jib																								Working range (m)
	13.5			31.5			36			40.5			45			49.5			54			58.5			
	0°	20°	40°	0°	20°	40°	0°	20°	40°	0°	20°	40°	0°	20°	40°	0°	20°	40°	0°	20°	40°	0°	20°	40°	
3																									3
3.5																									3.5
4																									4
4.5																									4.5
5																									5
6																									6
7	5.3																								7
8	5.3																								8
9	5.3			4.3																					9
10	5.3			4.3			4																		10
11	5.2			4.2			4			3.8															11
12	5			4.2			4			3.7															12
14	4.8			4.2			4			3.7			3.4			3									14
16	4.5			4.1			3.9			3.7			3.4			3									16
18	4.1			4			3.9			3.6			3.3			3		2.5			1.7				18
20	3.8	3.3		3.8			3.7			3.6			3.3			2.9		2.5			1.7				20
22	3.6	3		3.7			3.6			3.5			3.3			2.9		2.5			1.7				22
24	3.3	2.8		3.5	2.8		3.5			3.3			3.2			2.9		2.5			1.7				24
26	3	2.7		3.3	2.7		3.3	2.7		3.2	2.6		3.1			2.8		2.5			1.7				26
28	2.8	2.5		3.2	2.6		3.2	2.6		3.1	2.5		3	2.4		2.7		2.5			1.7				28
30	2.6	2.3	2	3	2.5		3	2.4		3	2.4		2.9	2.3		2.7	2.2	2.4			1.6				30
32	2.4	2.2	2	2.9	2.3		2.9	2.4		2.9	2.3		2.8	2.3		2.6	2.2	2.3	2		1.6				32
34	2.2	2.1	1.9	2.7	2.3	1.9	2.8	2.3		2.7	2.2		2.7	2.2		2.5	2.1	2.3	2		1.6				34
36	2	2	1.8	2.6	2.2	1.8	2.7	2.2	1.8	2.6	2.2	1.8	2.6	2.1		2.4	2	2.2	1.9		1.5	1.8			36
38	1.9	1.9	1.7	2.5	2.1	1.8	2.5	2.1	1.8	2.5	2.1	1.8	2.5	2	1.7	2.4	2	2.2	1.9		1.5	1.7			38
40	1.7	1.8	1.7	2.4	2	1.7	2.4	2	1.7	2.4	2	1.7	2.4	2	1.7	2.3	1.9	1.7	2.1	1.8		1.4	1.7		40
42	1.6	1.7	1.6	2.3	1.9	1.7	2.3	2	1.7	2.3	2	1.7	2.3	1.9	1.7	2.2	1.9	1.6	2.1	1.8	1.6	1.4	1.6		42
44	1.5	1.6		2.2	1.9	1.7	2.2	1.9	1.7	2.3	1.9	1.6	2.2	1.9	1.6	2.1	1.8	1.6	2	1.7	1.5	1.4	1.6	1.5	44
46	1.4			2.1	1.8	1.6	2.2	1.8	1.6	2.2	1.8	1.6	2.1	1.8	1.6	2.1	1.8	1.6	1.9	1.7	1.5	1.3	1.5	1.4	46
48				2	1.8	1.6	2.1	1.8	1.6	2.1	1.8	1.6	2.1	1.8	1.6	2	1.7	1.5	1.9	1.7	1.5	1.3	1.5	1.4	48
50				1.9	1.7	1.6	2	1.7	1.6	2	1.7	1.6	2	1.7	1.6	2	1.7	1.5	1.8	1.6	1.5	1.3	1.4	1.4	50
52				1.8	1.6	1.6	1.9	1.7	1.6	1.9	1.7	1.6	2	1.7	1.5	1.9	1.7	1.5	1.7	1.6	1.5	1.2	1.4	1.3	52
54				1.7	1.6	1.6	1.8	1.6	1.5	1.9	1.7	1.5	1.9	1.6	1.5	1.8	1.6	1.5	1.6	1.6	1.5	1.2	1.3	1.3	54
56				1.6	1.6	1.6	1.7	1.6	1.5	1.8	1.6	1.5	1.8	1.6	1.5	1.6	1.6	1.5	1.5	1.5	1.5	1.2	1.3	1.2	56
58				1.5	1.5		1.6	1.6	1.5	1.7	1.6	1.5	1.7	1.6	1.5	1.5	1.6	1.5	1.3	1.5	1.5	1.1	1.2	1.2	58
60				1.5	1.5		1.6	1.5		1.7	1.6	1.5	1.5	1.6	1.5	1.4	1.5	1.5	1.1	1.4	1.4	1	1.2	1.2	60
62				1.4	1.5		1.5	1.5		1.5	1.5	1.5	1.3	1.5	1.5	1.2	1.5	1.5	1	1.4	1.4		1.1	1.2	62
64				1.4			1.5	1.5		1.2	1.5		1.1	1.5	1.5	1	1.3	1.5		1.3	1.4		1	1.1	64
66							1.4	1.5		1	1.4		1.3	1.5	1.5		1.2	1.4		1	1.3		1	1	66
68										1.2			1.3				1.1	1.2			1.1			1	68
70													1.1								1.1				70
Number of line	1	1	1	1	1	1	1	1	1	1	1	1	1	1	1	1	1	1	1	1	1	1	1	1	Number of line

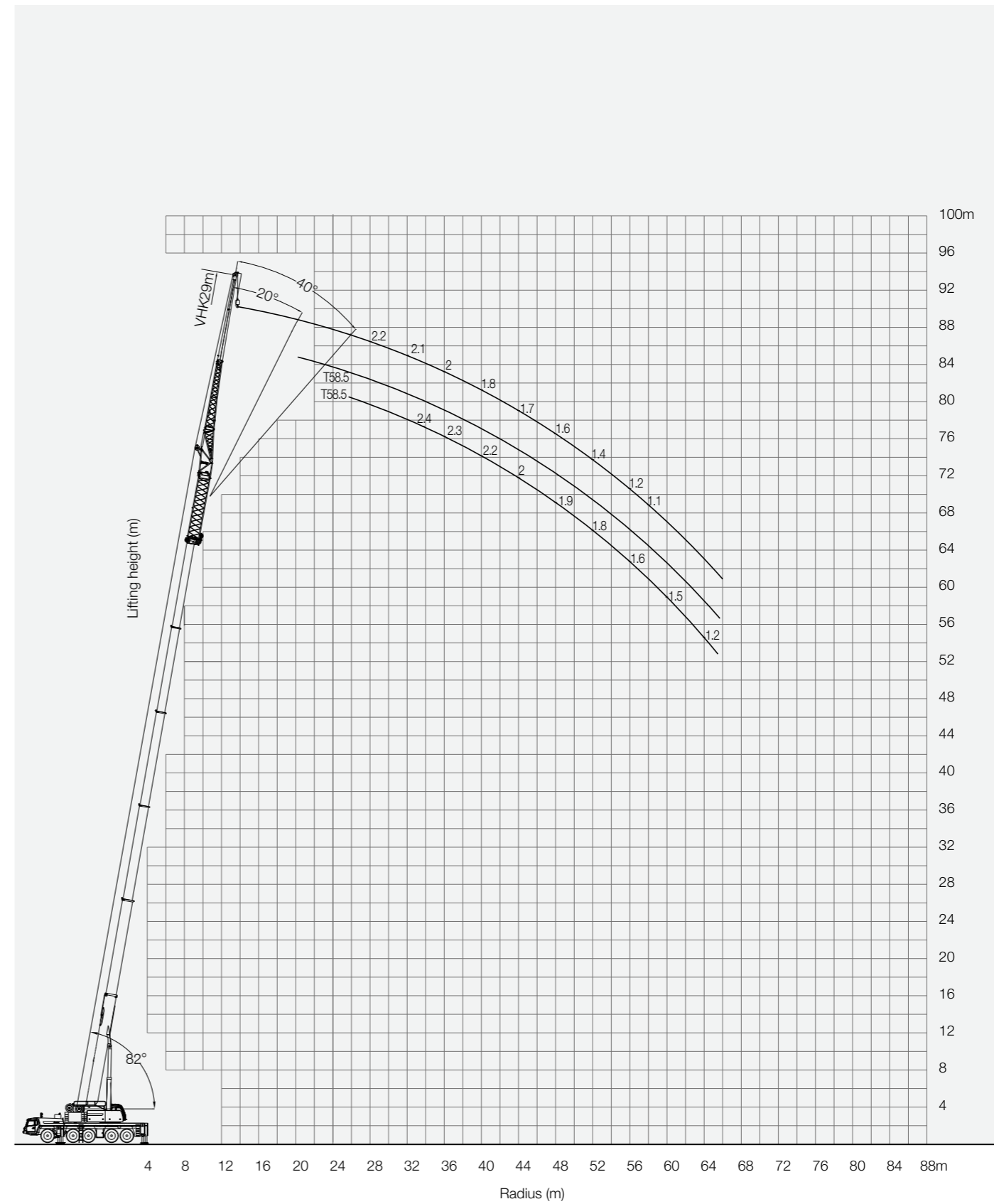

Prerequisites:

- ① Boom operating conditions (fully extended boom length + extending boom length + jib length), max.length is 62m+7m+22m
- ② The span of outriggers is 9.0m×8.5m
- ③ 360° rotation is applied
- ④ Counterweight is 60T

Working range (m)	Main boom+ Extending boom+ Jib																								Working range (m)	
	13.5			31.5			36			40.5			45			49.5			54			58.5				62
	0°	20°	40°	0°	20°	40°	0°	20°	40°	0°	20°	40°	0°	20°	40°	0°	20°	40°	0°	20°	40°	0°	20°	40°		0°
3																									3	
3.5																										3.5
4																										4
4.5	9.9																									4.5
5	9.9																									5
6	9.8																									6
7	9.5																									7
8	9.2			7.2																						8
9	8.9			7.1			6.7																			9
10	8.5			7.1			6.7		6.1																	10
11	8.1			7			6.6		6.1		5.5															11
12	7.7			6.8			6.5		6		5.4															12
14	6.9	6.1		6.5			6.2		5.8		5.3			4.7												14
16	6.1	5.4		6.1			6		5.6		5.1			4.6												16
18	5.4	4.8		5.8	4.9		5.7	4.9	5.4		5			4.5			3.9				3.2			2.5	18	
20	4.8	4.4	4.1	5.5	4.6		5.4	4.6	5.1	4.5	4.8			4.3			3.8			3.1			2.4	20		
22	4.3	4.1	3.8	5.1	4.4		5.1	4.4	4.9	4.3	4.6	4.1		4.2			3.7			3.1			2.3	22		
24	3.9	3.7	3.5	4.8	4.1	3.6	4.9	4.1	3.6	4.7	4.1	4.4	4	4.1	3.7		3.6			3			2.3	24		
26	3.5	3.5	3.3	4.5	3.9	3.5	4.6	3.9	3.5	4.5	3.9	3.5	4.3	3.8		4	3.6			3.5	3.3		3	2.2	26	
28	3.3	3.2	3.1	4.3	3.7	3.3	4.4	3.7	3.3	4.3	3.7	3.3	4.1	3.6	3.3	3.8	3.5	3.2	3.4	3.2	2.9	2.8		2.2	28	
30	3	3	2.9	4	3.5	3.2	4.1	3.6	3.2	4.1	3.6	3.2	4	3.5	3.2	3.7	3.4	3.1	3.3	3.1	2.8	2.7		2.1	30	
32	2.8	2.8	2.7	3.8	3.3	3.1	3.9	3.4	3.1	3.9	3.4	3.1	3.8	3.4	3.1	3.6	3.2	3	3.2	3	2.8	2.7	2.6		2.1	32
34	2.6	2.6	2.6	3.6	3.2	2.9	3.7	3.2	3	3.8	3.3	3	3.7	3.2	3	3.5	3.1	2.9	3.1	2.9	2.7	2.6	2.5	2.4	2	34
36	2.4	2.4		3.4	3	2.8	3.5	3.1	2.9	3.6	3.1	2.9	3.5	3.1	2.9	3.4	3	2.8	3	2.8	2.7	2.5	2.4	2.3	2	36
38	2.3	2.3		3.2	2.9	2.7	3.4	3	2.8	3.4	3	2.8	3.4	3	2.8	3.2	2.9	2.7	2.9	2.8	2.6	2.4	2.3	2.2	1.9	38
40				3	2.8	2.7	3.2	2.9	2.7	3.3	2.9	2.7	3.3	2.9	2.7	3.1	2.8	2.6	2.7	2.7	2.5	2.3	2.2	2.2	1.8	40
42				2.9	2.7	2.6	3	2.8	2.6	3.1	2.8	2.6	3.1	2.8	2.6	3	2.7	2.6	2.6	2.6	2.5	2.2	2.1	2.1	1.8	42
44				2.8	2.6	2.5	2.9	2.6	2.6	3	2.7	2.6	3	2.7	2.6	2.9	2.6	2.5	2.5	2.5	2.4	2.1	2	2	1.7	44
46				2.6	2.5	2.4	2.8	2.6	2.5	2.9	2.6	2.5	2.9	2.6	2.5	2.8	2.6	2.5	2.4	2.4	2.4	2	2	2	1.7	46
48				2.5	2.4	1.6	2.7	2.5	2.4	2.8	2.5	2.5	2.8	2.5	2.5	2.6	2.5	2.4	2.3	2.3	2.3	1.9	1.9	1.9	1.6	48
50				2.4	2.3		2.5	2.4	2.4	2.7	2.4	2.4	2.6	2.5	2.4	2.4	2.4	2.4	2.1	2.2	2.2	1.8	1.8	1.8	1.5	50
52				2.3	2.2		2.4	2.3		2.5	2.4	2.4	2.4	2.4	2.4	2.1	2.3	2.3	2	2.1	2.1	1.7	1.7	1.8	1.4	52
54				2.2	2.2		2.3	2.3		2.4	2.3	2.3	2.2	2.3	2.3	1.9	2.2	2.3	1.8	2	2	1.6	1.6	1.7	1.3	54
56				2.1			2.3	2.2		2.1	2.2		2	2.3	2.3	1.7	2	2.2	1.5	1.9	1.9	1.5	1.6	1.6	1.2	56
58							2.2	2.2		1.8	2.2		1.7	2.1	2.1	1.6	1.7	1.9	1.4	1.7	1.8	1.3	1.5	1.5	1.1	58
60							2			1.6	1.8		1.4	1.8		1.4	1.6	1.7	1.3	1.4	1.7	1	1.4	1.5		60
62										1.3	1.5		1.2	1.5		1.1	1.5	1.6	1.2	1.3	1.4		1.2	1.4		62
64											1.1			1.2		1	1.2			1.2	1.3		1.2			64
66																	1									66
68																		1.1								68
Number of line	1	1	1	1	1	1	1	1	1	1	1	1	1	1	1	1	1	1	1	1	1	1	1	1	1	Number of line

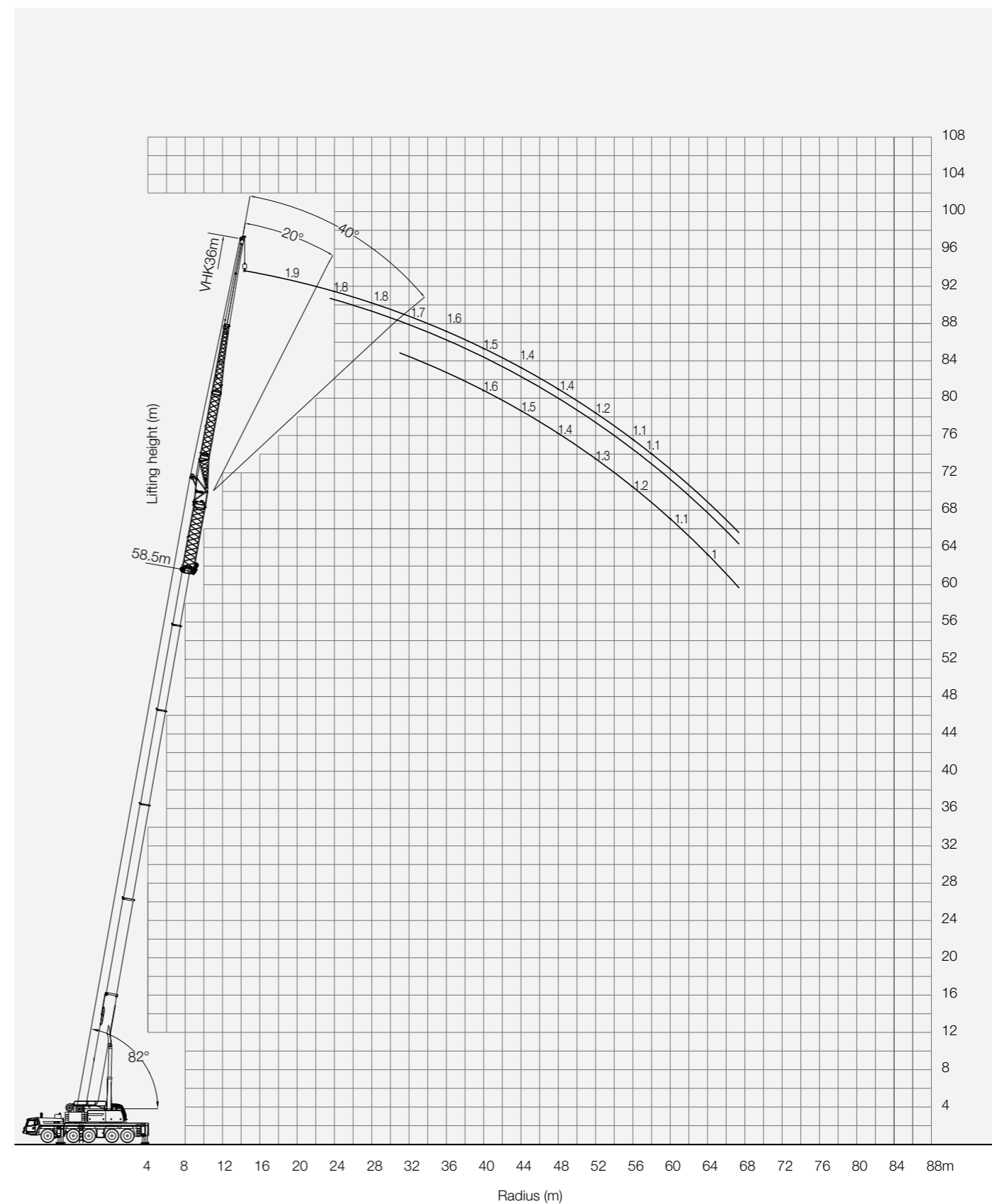

- Prerequisites:**
- ① Boom operating conditions(boom length +extending boom length+jib length), max.length is 62m+7m+29m
 - ② The span of outriggers is 9.0m×8.5m
 - ③ 360° rotation is applied
 - ④ Counterweight is 60T

Working range (m)	Main boom + Extending boom+ Jib																								Working range (m)	
	13.5			31.5			36			40.5			45			49.5			54			58.5				
	0°	20°	40°	0°	20°	40°	0°	20°	40°	0°	20°	40°	0°	20°	40°	0°	20°	40°	0°	20°	40°	0°	20°	40°		
3																									3	
3.5																										3.5
4																										4
4.5																										4.5
5																										5
6	6.5																									6
7	6.4																									7
8	6.4																									8
9	6.3			5																						9
10	6.2			5			4.7																			10
11	6			5			4.7																			11
12	5.8			4.9			4.7			4.3																12
14	5.4			4.8			4.6			4.3			3.9													14
16	5			4.6			4.4			4.2			3.9													16
18	4.6	4.1		4.4			4.3			4.1			3.8			3.4			2.9			1.9				18
20	4.2	3.7		4.2			4.1			3.9			3.6			3.3			2.8			1.9				20
22	3.8	3.4		4	3.4		3.9	3.4		3.8			3.5			3.2			2.8			1.9				22
24	3.4	3.1		3.8	3.2		3.7	3.2		3.6	3.2		3.4			3.1			2.7			1.9				24
26	3.1	2.9	2.7	3.6	3		3.6	3		3.4	3		3.3	2.9		3			2.6			1.8				26
28	2.9	2.6	2.5	3.4	2.9		3.4	2.9		3.3	2.9		3.1	2.8		2.9	2.6		2.6			1.8				28
30	2.6	2.4	2.3	3.2	2.7	2.4	3.2	2.7	2.4	3.2	2.7		3	2.7		2.8	2.5		2.5	2.3		1.7				30
32	2.4	2.3	2.2	3	2.6	2.3	3.1	2.6	2.3	3	2.6	2.3	2.9	2.5		2.7	2.4		2.4	2.2		1.7	1.9			32
34	2.2	2.1	2	2.8	2.4	2.2	2.9	2.5	2.2	2.9	2.5	2.2	2.8	2.4	2.2	2.6	2.3		2.4	2.2		1.6	1.8			34
36	2	2	1.9	2.6	2.3	2.1	2.8	2.4	2.1	2.8	2.4	2.1	2.7	2.3	2.1	2.5	2.2	2	2.3	2.1		1.6	1.8			36
38	1.9	1.8	1.8	2.5	2.2	2	2.6	2.2	2	2.6	2.3	2	2.6	2.2	2	2.4	2.2	2	2.2	2	1.9	1.5	1.7			38
40	1.8	1.7	1.7	2.4	2.1	1.9	2.5	2	2	2.5	2.2	2	2.5	2.1	1.9	2.4	2.1	1.9	2.2	2	1.8	1.5	1.7	1.6		40
42	1.6	1.6		2.2	2	1.9	2.3	2	1.9	2.4	2.1	1.9	2.4	2.1	1.9	2.3	2	1.8	2.1	1.9	1.8	1.5	1.6	1.5		42
44	1.5	1.5		2.1	1.9	1.8	2.2	1.9	1.8	2.3	2	1.8	2.3	2	1.8	2.2	1.9	1.8	2	1.8	1.7	1.4	1.6	1.5		44
46	1.4			2	1.8	1.7	2.1	1.9	1.8	2.2	1.9	1.8	2.2	1.9	1.8	2.1	1.9	1.7	2	1.8	1.7	1.4	1.5	1.5		46
48				1.9	1.7	1.7	2	1.8	1.7	2.1	1.8	1.7	2.1	1.8	1.7	2	1.8	1.7	1.9	1.7	1.6	1.4	1.4	1.4		48
50				1.8	1.7	1.6	1.9	1.7	1.7	2	1.8	1.7	2	1.8	1.7	2.1	1.7	1.6	1.8	1.7	1.6	1.3	1.4	1.4		50
52				1.7	1.6	1.6	1.8	1.7	1.6	1.9	1.7	1.6	1.9	1.7	1.6	1.9	1.7	1.6	1.7	1.6	1.5	1.2	1.3	1.3		52
54				1.6	1.5	1.5	1.7	1.6	1.6	1.8	1.6	1.6	1.8	1.6	1.6	1.8	1.6	1.6	1.6	1.5	1.5	1.2	1.3	1.3		54
56				1.6	1.5		1.7	1.5	1.5	1.7	1.6	1.5	1.7	1.6	1.5	1.6	1.5	1.4	1.5	1.5	1.1	1.2	1.2			56
58				1.5	1.4		1.6	1.5	1.5	1.7	1.5	1.5	1.6	1.5	1.5	1.4	1.5	1.5	1.2	1.4	1.4	1.1	1.1	1.2		58
60				1.4	1.4		1.5	1.4		1.6	1.5	1.5	1.5	1.5	1.5	1.3	1.5	1.5	1	1.4	1.4		1.1	1.1		60
62				1.4	1.4		1.5	1.4		1.4	1.4	1.5	1.2	1.4	1.5	1.1	1.3	1.4		1.3	1.4		1	1.1		62
64				1.4			1.4	1.4		1.2	1.4		1	1.4	1.4		1.2	1.4		1	1.3			1		64
66							1.4	1.4			1.3					1.2	1.3									66
68										1									1.1							68
Number of line	1	1	1	1	1	1	1	1	1	1	1	1	1	1	1	1	1	1	1	1	1	1	1	1	1	Number of line

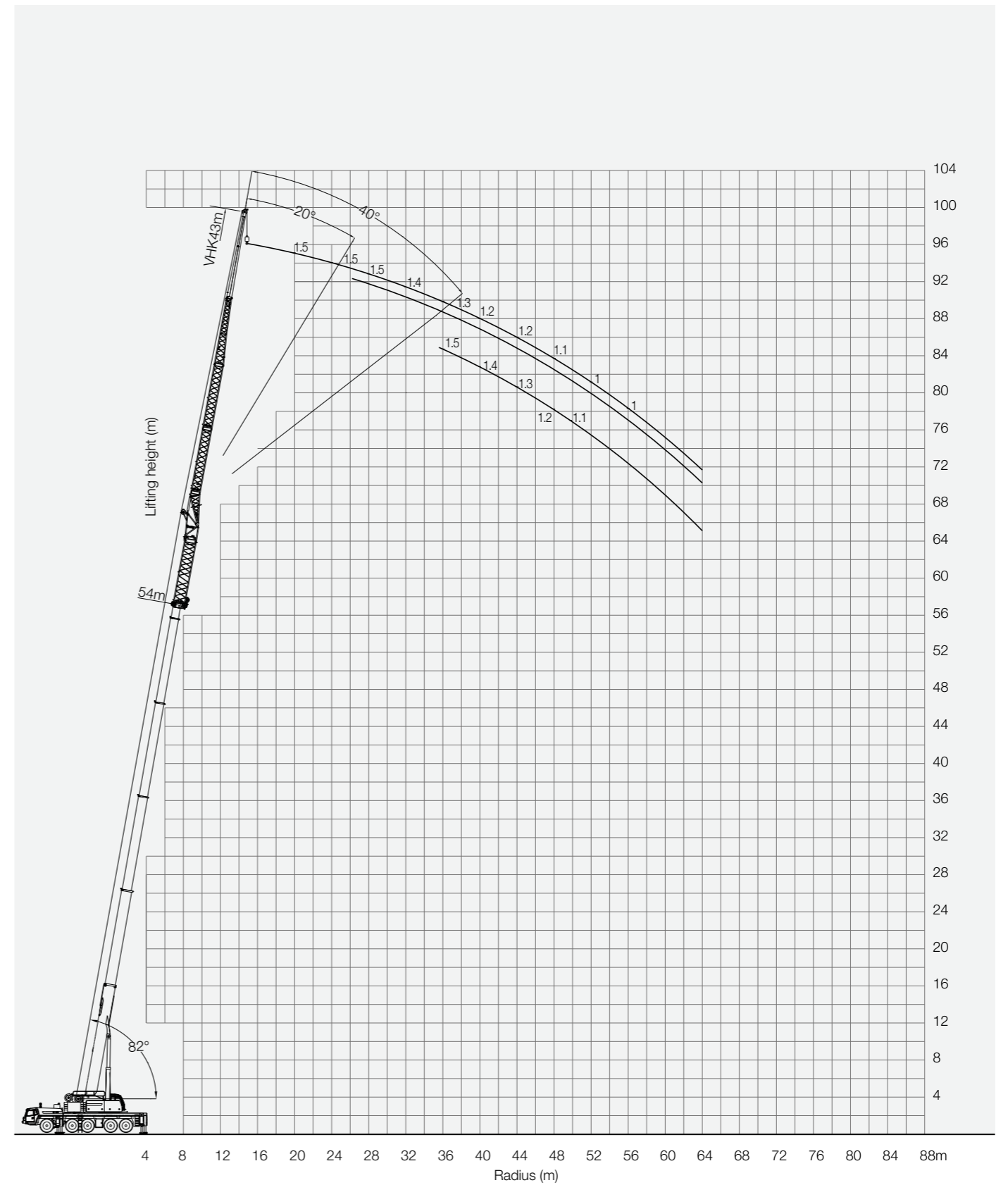

Prerequisites:





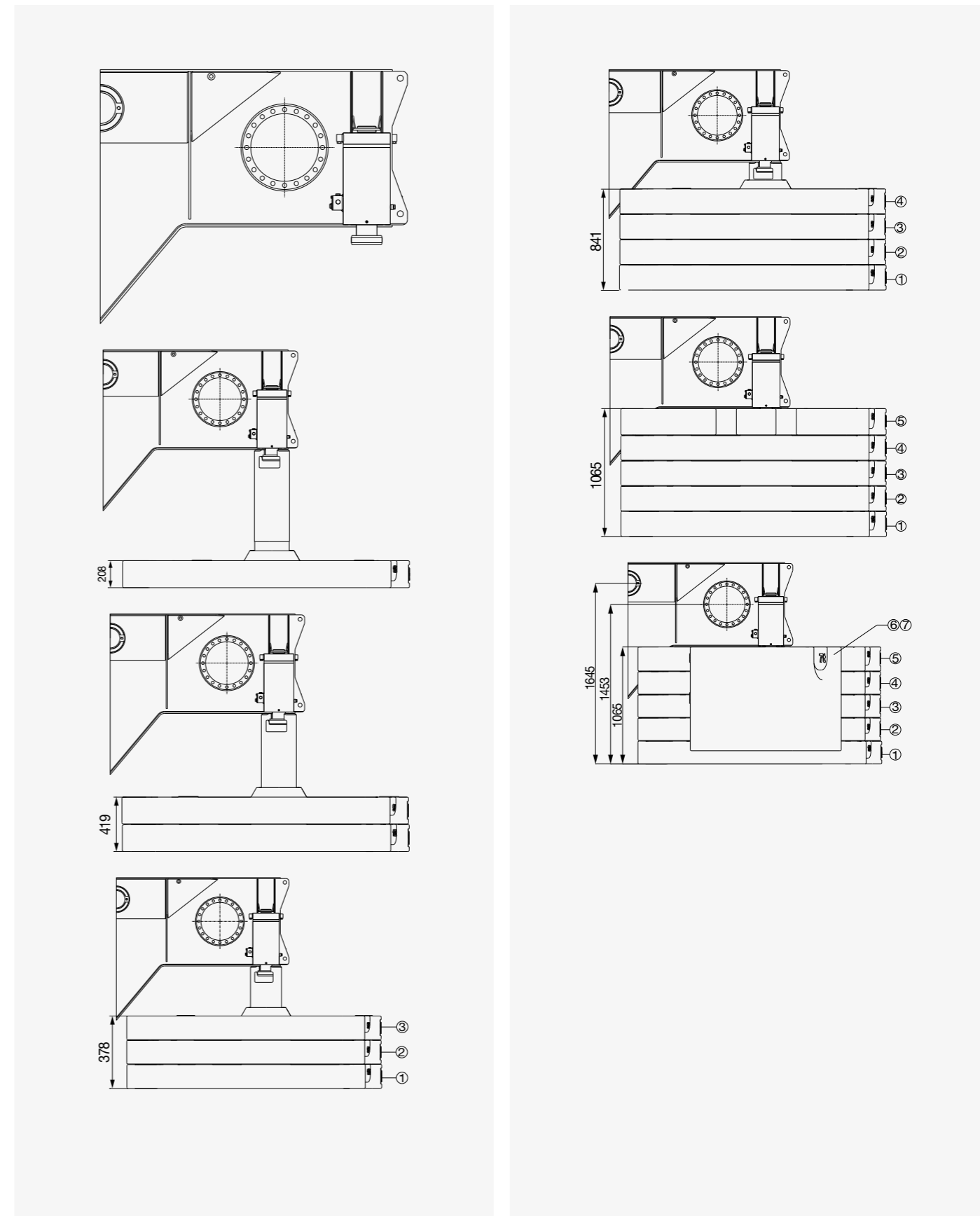

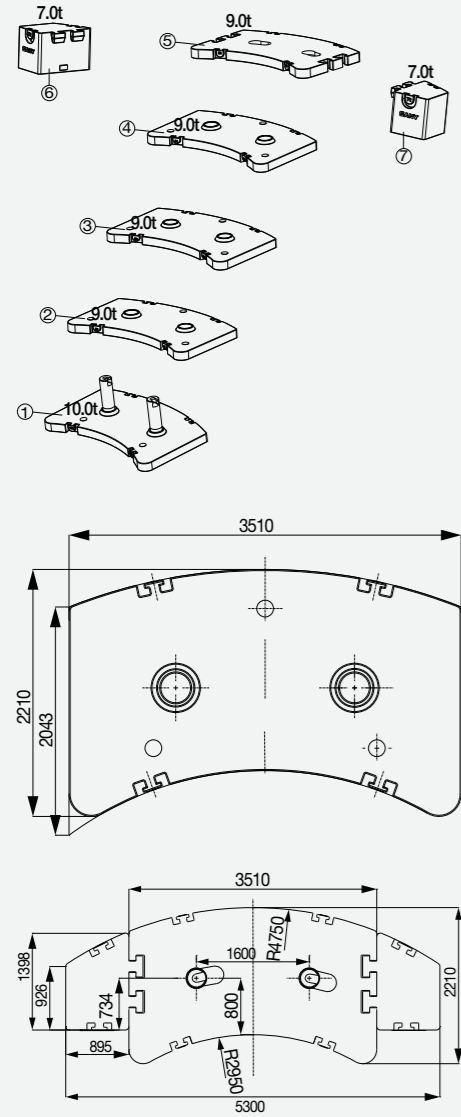











- ① Boom operating conditions(boom length +jib extending boom length+main jib length), max.length is 62m+7m+36m
- ② The span of outriggers is 9.0m×8.5m
- ③ 360°rotation is applied
- ④ Counterweight is 60T

Working range (m)	Main boom + Extending boom+ Jib																				Working range (m)	
	13.5			31.5			36			40.5			45			49.5			54			
	0°	20°	40°	0°	20°	40°	0°	20°	40°	0°	20°	40°	0°	20°	40°	0°	20°	40°	0°	20°		40°
3																						3
3.5																						3.5
4																						4
4.5																						4.5
5																						5
6																						6
7																						7
8	4.6																					8
9	4.5																					9
10	4.5																					10
11	4.5			3																		11
12	4.4			3			3															12
14	4.2			3			3			3												14
16	3.9			3			3			3				2.8								16
18	3.7			3			3			3				2.7		2.4				1.5		18
20	3.4			3			3			2.9				2.7		2.4				1.5		20
22	3.1	2.9	2.9	3			3			2.8				2.6		2.3				1.5		22
24	2.9	2.6	2.6	2.9			2.8			2.7				2.5		2.3				1.5		24
26	2.6	2.4	2.4	2.8	2.4	2.4	2.7			2.6				2.4		2.2				1.5		26
28	2.4	2.2	2.2	2.6	2.2	2.2	2.6	2.2	2.2	2.5	2.2	2.2	2.3			2.1				1.5		28
30	2.2	2	2	2.5	2.1	2.1	2.5	2.1	2.1	2.4	2.1	2.1	2.3	2	2	2.1				1.4		30
32	2	1.8	1.8	2.3	2	2	2.3	2	2	2.3	2	2	2.2	1.9	1.9	2	1.8	1.8	1.4			32
34	1.8	1.7	1.7	2.2	1.9	1.9	2.2	1.9	1.9	2.2	1.9	1.9	2.1	1.8	1.8	1.9	1.7	1.7	1.3			34
36	1.6	1.6	1.6	2.1	1.8	1.8	2.1	1.8	1.8	2.1	1.8	1.8	2	1.7	1.7	1.8	1.6	1.6	1.3	1.5	1.5	36
38	1.5	1.4	1.4	1.9	1.7	1.7	2	1.7	1.7	2	1.7	1.7	1.9	1.6	1.6	1.8	1.6	1.6	1.3	1.4	1.4	38
40	1.4	1.3	1.3	1.8	1.6	1.6	1.9	1.6	1.6	1.9	1.6	1.6	1.8	1.6	1.6	1.7	1.5	1.5	1.2	1.4	1.4	40
42	1.3	1.2	1.2	1.7	1.5	1.5	1.8	1.5	1.5	1.8	1.5	1.5	1.7	1.5	1.5	1.6	1.4	1.4	1.2	1.3	1.3	42
44	1.2	1.1	1.1	1.6	1.4	1.4	1.7	1.4	1.4	1.7	1.4	1.4	1.7	1.4	1.4	1.6	1.4	1.4	1.2	1.3	1.3	44
46	1.1			1.5	1.3	1.3	1.6	1.4	1.4	1.6	1.4	1.4	1.6	1.4	1.4	1.5	1.3	1.3	1.1	1.2	1.2	46
48	1			1.4	1.2	1.2	1.5	1.3	1.3	1.5	1.3	1.3	1.5	1.3	1.3	1.5	1.3	1.3	1.1	1.2	1.2	48
50				1.3	1.2	1.2	1.4	1.2	1.2	1.4	1.2	1.2	1.4	1.2	1.2	1.4	1.2	1.2	1.7	1.1	1.1	50
52				1.2	1.1	1	1.3	1.1	1.1	1.4	1.2	1.1	1.4	1.2	1.1	1.3	1.1	1	1	1.1		52
54				1.2	1	1	1.2	1.1	1	1.3	1.1	1	1.3	1.1	1	1.3	1.1	1	1	1		54
56				1.1	1	1	1.2	1	1	1.2	1.1	1	1.2	1.1	1	1.2	1	1	1	1		56
58				1			1.1	1		1.1	1	1	1.2	1	1	1.1	1					58
60				1			1			1.1	1		1.1	1		1						60
62										1			1									62
64										1			1									64
66																						66
68																						68
Number of line	1	1	1	1	1	1	1	1	1	1	1	1	1	1	1	1	1	1	1	1	1	Number of line





TRUCK CRANE

 STC200 Maximum Load Capacity: 20t Telescopic Boom: 4 Sections, 10.6-33m	 STC250 Maximum Load Capacity: 25t Telescopic Boom: 4 Sections, 10.65-33.5m	 STC250H Maximum Load Capacity: 25t Telescopic Boom: 5 Sections, 10.5-39.5m	 STC300S Maximum Load Capacity: 30t Telescopic Boom: 5 Sections, 10.6-40.5m	 STC300TH Maximum Load Capacity: 30t Telescopic Boom: 4 Sections, 10.6-33.5m
 STC300H Maximum Load Capacity: 30t Telescopic Boom: 5 Sections, 10.5-39.5m	 STC500 Maximum Load Capacity: 50t Telescopic Boom: 5 Sections, 11.5-43m	 STC550 Maximum Load Capacity: 55t Telescopic Boom: 5 Sections, 11.5-43m	 STC600S Maximum Load Capacity: 60t Telescopic Boom: 5 Sections, 11.3-43.5m	 STC750 Maximum Load Capacity: 75t Telescopic Boom: 5 Sections, 11.8-45m
 STC800S Maximum Load Capacity: 80t Telescopic Boom: 5 Sections, 12.2-47m	 STC1000 Maximum Load Capacity: 100t Telescopic Boom: 5 Sections, 13.5-52m	 STC1000C Maximum Load Capacity: 100t Telescopic Boom: 6 Sections, 13.25-60m	 STC1000S Maximum Load Capacity: 100t Telescopic Boom: 5 Sections, 12.26-56m	 STC1200S Maximum Load Capacity: 120t Telescopic Boom: 7 Sections, 12.6-63.5m
 STC1300C Maximum Load Capacity: 130t Telescopic Boom: 6 Sections, 13.3-69m	 STC1600 Maximum Load Capacity: 160t Telescopic Boom: 6 Sections, 13.4-69m	 STC2200 Maximum Load Capacity: 220t Telescopic Boom: 6 Sections, 14.55-68m		

ALL TERRAIN CRANE

 SAC1800 Maximum Load Capacity: 180t Telescopic Boom: 6 Sections, 15.5-62m	 SAC2200 Maximum Load Capacity: 220t Telescopic Boom: 6 Sections, 13.5-62m	 SAC2600 Maximum Load Capacity: 260t Telescopic Boom: 6 Sections, 15.65-73m	 SAC3000 Maximum Load Capacity: 300t Telescopic Boom: 7 Sections, 15.4-83m
 SAC3500 Maximum Load Capacity: 350t Telescopic Boom: 6 Sections, 15.2-70m	 SAC6000 Maximum Load Capacity: 600t Telescopic Boom: 7 Sections, 17.1-90m		

ROUGH-TERRAIN CRANE

 SRC250 Maximum Load Capacity: 25t Telescopic Boom: 4 Sections, 9.9-31.5m	 SRC350 Maximum Load Capacity: 35t Telescopic Boom: 4 Sections, 10-31.5m	 SRC650 Maximum Load Capacity: 65t Telescopic Boom: 4 Sections, 11.25-34.5m	 SRC660H Maximum Load Capacity: 65t Telescopic Boom: 5 Sections, 11.5-43m	 SRC750 Maximum Load Capacity: 75t Telescopic Boom: 5 Sections, 11.8-45m
 SRC1200 Maximum Load Capacity: 120t Telescopic Boom: 5 Sections, 13-49m				



Quality Changes the World

SANY AUTOMOBILE HOISTING MACHINERY

Address: SANY Industrial Park, Jinzhou Development Zone,
Changsha, Hunan, China.
Service Hotline: 4006098318
Email: crd@sany.com.cn
For more information, please visit: www.sanygroup.com

For our consistent improvement in technology, specifications may change without notice.
The machines illustrated may show optional equipment which can be supplied at additional cost.

Version: 2015.08

Distributed By: