

SAC6000

SAC6000 ALL-TERRAIN CRANE
600 TONS LIFTING CAPACITY

Quality Changes the World

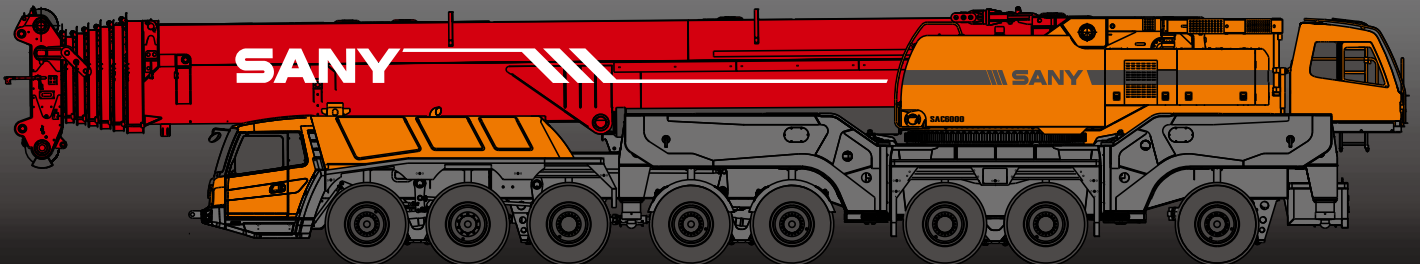

SANY

■ SANY Automobile Hoisting Machinery is one of the core business units of Sany Heavy Industry, mainly engaged in the research and development of high-end, mid-to-large tonnage crane series, including mobile crane, crawler crane, tower crane and loader crane. It has two industrial parks in Ningxiang and Huzhou. Since entering the market, the products of Sany Automobile Hoisting Machinery have received worldwide recognition with advanced technology, lean manufacturing, high reliability and excellent service.



SANY ALL-TERRAIN CRANE

CONTENT

- 04 Icon
- 05 Selling points
- 06 Introduction
- 11 Dimension
- 12 Technical Parameter
- 13 Operation Condition
- 14 Load Chart
- 43 Counterweight sketch Map
- 45 Wheel Crane Family Map



Excellent and stable chassis performance

The use of innovative 8-axle chassis design with six driving modes and four braking modes, providing more reliable traveling performance. High stability and safety are guaranteed with tipping over early-warning technology.



Ultra long Boom for Wide Working Radius

The Max. length of boom and tower jib is 90m respectively, which ensures Max. lifting height with tower jib up to 136m. Fixed jib is 42m and are equipped with 0°~40° infinitely automatically variable luffing, ensuring conveniently switching over between all operating conditions with high efficiency.



Highly efficient, energy-saving and unique hydraulic control technology

Self-developed dual-pump converging / diversion main valve is used. Converging flow of the single-action dual-pump ensures fast operation and high work efficiency, combined-action dual-pump diversion system is applied to ensure stable controllability. Electric proportional variable displacement piston pump is used to ensure high-accurate flow control with higher efficiency and energy saving.





Safe, stable, advanced and intelligent electronic control technology

The adoption of internationally advanced distributed integration bus data communication network and the configuration of abundant sensing elements can achieve timely feedback of data information and monitor the overall working status in real-time. The human-computer interaction interface is used to meet with customer's individual requirements.

Superstructure

-  **Cab**
- It is made of safety glass and anti-corrosion steel plate with ergonomic design such as full-coverage soften interior, panoramic sunroof and adjustable seats etc. humanized design, providing more comfortable and relaxing operation experience. The display of load moment limiter integrates main console and operation display system, which clearly show the data of all operating superstructure conditions for lifting operation.

-  **Engine**
- Type: Inline six-cylinder, water cooled, supercharged and inter-cooling diesel engine
 - Rated power: 205kw/2200r/min
 - Environment-protection: Emission complies with EuroIII standard
 - Capacity of fuel tank: 400L

-  **Hydraulic system**
- The adoption of high-quality hydraulic components ensures high reliability and long service life. Accurate parameter matching provides more excellent operation performance.
 - The electric proportional variable displacement piston pump is used to adjust the pump displacement in real-time through changing the opening of the electrical control handle, thus achieving high-precision flow control with no-loss of energy during operation.
 - Self-developed dual-pump converging / diversion main valve is used with multiple pressure selection function to satisfy the pressure demands of different working conditions, ensuring stable overall crane action and reducing energy consumption.
 - Main winch adopts the closed winch system with high working efficiency and low energy cost, ensuring excellent micro-mobility and stability of winch. It is equipped with four level protection system, making winch system more secure and reliable.
 - The use of dead-weight luffing compensation hydraulic system ensures excellent lowering micro-mobility and stability.
 - The unique single-cylinder pin locking telescopic boom technology is adopted, providing higher reliability with cylinder boom pin interlock combining mechanic, electric and hydraulic triple protections, ensuring high reliability.
 - The closed system is used by slewing system to avoid the energy-saving cost of the open system, ensuring higher efficiency. The system has load sensitive features, low speed travelling under heavy load and high speed travelling under light load and high action efficiency functions. Emergency brake and slow brake can be achieved through electric proportion pressure reduce valve, which makes movement more stable and efficient.

-  **Control system**
- The PLC integrated programmable controller and CAN-bus control network are used to achieve logic control and electric proportional control of the system by combining with the common electricity.
 - With real-time monitoring and fault self-diagnosis system except for normal control function.
 - Lifting, slewing and luffing can be controlled by electrical proportion of lifting, Lifting and lowering of counterweight, shifting of cab and locking of rotating bed can be controlled through the keys on the control panel.
 - Display can be connected with the controller via CAN-bus with main functions as follows: digital adjustment and display of the electric proportional control parameters, display of fault code of the electric proportional system and real-time data display by the hydraulic system.

Superstructure

-  **Luffing system**
- The top double-cylinder luffing is applied with luffing angle ranging from -0.5° ~ 86° . Hydraulic system adopts the dual-pump converging open hydraulic circuit and combine electro proportional control, power lowering with self-weight luffing, achieving large-angle fast lowering and small-angle stable and slow lowering operations.

-  **Telescopic boom**
- It consists of seven section booms welded with bended fine-grain high-strength steel plate, with oval section applied to ensure good buckling resistance performance, with single-cylinder automatic pin system, a dual-action cylinder can control telescopic operation of all booms and achieve a variety of boom combinations.
 - Standard configuration of boom end pulley is 13 pulleys.
 - The boom length is 90m.

-  **Lattice jibs**
- There are fixed jib and tower jib. The adaptor, jib head, and 6m and 12m large (small) sectional standard sections are shared by fixed jib and tower jib. 12m~42m boom combination can be achieved for fixed jib. The application of $0\sim 40^{\circ}$ infinitely luffing jib improves automation level and working efficiency through changing the angle according to the actual demands of the operating condition. With tower jib equipped with 24m~90m jib combination, thus greatly improving lifting capacity and operating height.
 - Equipped with 6m special jib for wind turbine installation, featuring good adaptability to wind turbine working conditions and strong lifting capacity.

-  **Superlift devices**
- The stress applied on the lifting boom can be reduced to avoid side bending and to reduce down-warping deformation. Therefore, under long boom state, deflection can be reduced and the lifting capacity can be improved.

-  **Slewing system**
- It consists of constant displacement motor and slewing reducer with mature technology. 360° rotation can be achieved through external gearing with slewing ring. With slewing speed of 0-0.9rpm and with infinitely variable speed adjustment. Slewing hydraulic system adopts the closed system, which not only avoids throttling loss of the open system but also ensures a high efficiency. Emergency brake can be achieved through electric proportional brake pedal.

-  **Main hoisting system**
- Planet-gear speed reducer and special groove winch drum are driven by hydraulic motor with brake installed internally.
 - Wire rope lock: High-quality wire rope lock with casting at ends is applied. It is installed in the lock sleeve directly, which improves the replacement speed of the lifting rate.
 - Spec. of wire rope: $\phi 25$, non-rotating.
 - Length: About 760m.
 - Max. single rope speed (outer layer): about 130m/min.

Superstructure

Tower boom winch mechanism

- Planet-gear speed reducer and special groove winch drum are driven by hydraulic motor with brake installed internally. Anti-winding wire rope is used. Separate rotation can be achieved together with the auxiliary hoisting system.
- Spec. of wire rope: ϕ 25, non-rotating.
- Length: About 1100m.
- Max. single rope speed (outer layer): about 130m/min.

Safety system

- Load moment limiter: With analytical mechanics method, the load moment limiter calculation system is established based on the load mechanical model. The rated hoisting accurate can be up to $\pm 3\%$ through on-line non-load calibration.
- Hydraulic system is configured with the balance valve, overflow valve, and two-way hydraulic lock etc., ensuring stable and reliable operation of the hydraulic system;
- Main and auxiliary winches are configured with 3-wraps protectors to prevent over roll-out of wire rope.
- Boom and jib are configured with height limiters at ends to prevent over-hoist of the wire rope.
- Boom head is equipped with anemometer to detect whether the high-altitude wind speed is within the allowable range.
- With superlift rope rewinding and release pull protection procedure and tower (jib) boom installation and lifting load protection procedure.

Counterweight

- Combined variable counterweights are used with 0t, 30t, 45t, 60t, 75t, 90t, 105t, 135t, 165t nine combinations to meet requirements of different operating conditions and maximize structural parts performance, which can be self-assembled and disassembled.

Chassis

Cab

- Cab is made of new steel structure self-developed by SANY, featuring excellent shock absorption and tightness. It is configured with swing-out doors at both sides, pneumatically suspended driver's seat and passenger's seat, adjustable steering wheel, large rearview mirror, comfortable driver's chair with a headrest, anti-fog fan, air conditioner, stereo radio and complete control instruments and meters, providing more comfortable and safe operation experience.

Carrier frame

- Designed and manufactured by SANY, anti-torsion box structure is welded by fine-grain high-strength steel plate to provide strong load bearing capacity.

Axles

- Full-axle steering is applied with axles 1, 2, 4 and 5 used for drive operation, axles 1, 2, 3 and 4 adopt the bar-feedback hydraulic power steering systems and axles 5,6,7 and 8 adopt the electrohydraulic control steering system with assist in speed control and special steering mode optional applied, thus ensuring easy steering and flexible operation.

Engine

- Type: Electric controlled, V- type eight-cylinder, water cooled, supercharged and inter-cooling diesel engine.
- Rated power: 480kw/1800r/min
- Max torque: 3000Nm/1300rpm
- Environment-protection: Emission complies with EuroIV standard
- Capacity of fuel tank: 550L

Transmission system

- Gearbox: Manual /Automatic gearbox is adopted with 12-gear and large speed ratio range applied, which meets the requirements of low gradeability speed and high speed traveling.
- Transfer case: Transfer case with a large input torque is used with rated torque up to 30000N.m and with differential lock cylinder configured.
- Transmission shaft: With optimized arrangement of the transmission shaft, the transmission is more stable and reliable. For most optimized transmission, face-tooth coupling transmission shaft is used with large transmission torque.

Brakes system

- To ensure its reliability and security of brake system, it consists of 4 independent types of brake systems.
- Traveling brake: All wheels use dual-circuit pressure brakes
- Parking brake: Spring accumulator is used for cutting-off brake;
- Emergency brake: Spring accumulator is used not only for cutting-off brake but also for emergency brake;
- Slow brake: Engine is equipped with dual brake and transmission equipped with hydrodynamic retarder brake, five-bridge eddy-current retarder brake.

Suspension system

- Axle suspension devices adopt the height-adjustable oil-gas suspension devices equipping with the hydraulic lock with stroke of suspension cylinder of +160/-130mm to achieve suspension, rigid locking, automatic leveling, overall lifting and lowering, single-point lifting and lowering modes. Load applied on each axle is no more than 12t. With good trafficability and adaptability of a variety of severe operating conditions and road, smooth and comfortable travelling and side stability of the vehicle are guaranteed.

Chassis

Steering system

- Servo power steering gear and dual-circuit system hydraulic steering device are used with emergency steering pump equipped.
- Six types steering modes: 1) Road running mode (default mode). 2) Full-wheel steering mode. 3) Crab-type mode. 4) Steering mode without deflection. 5) Independent rear-axle steering mode. 6) Steering mode with rear axle locked.

Outriggers

- Four-point supporting of the X-shaped outriggers ensures easy operation and strong stability with Max. span up to 10.8m×10.8m. Outrigger telescopic hydraulic system adopts the electro proportional control technology with wireless remote control configured. Outrigger control panel can display all loads with automatic level function to ensure high control precision and simple operation.

Tyres

- 12*—16.00R25

Electrical system

- With 24V DC power supply, cutting off power of the undercarriage can be achieved. Automotive lighting system is equipped. Vehicle actions such as throttle and outrigger control can be electrically controlled. Electrical system has strong detection, logic, and calculation capacity with fault self-diagnosis, centralized display and self-protection function.
- Chassis adopts CAN-bus system; multifunctional centralized display system is used. Power consumption is small with maximum value of only 5w. Four functional keys are provided on the user interface. LCD display is used, with adjustable contrast ratio.

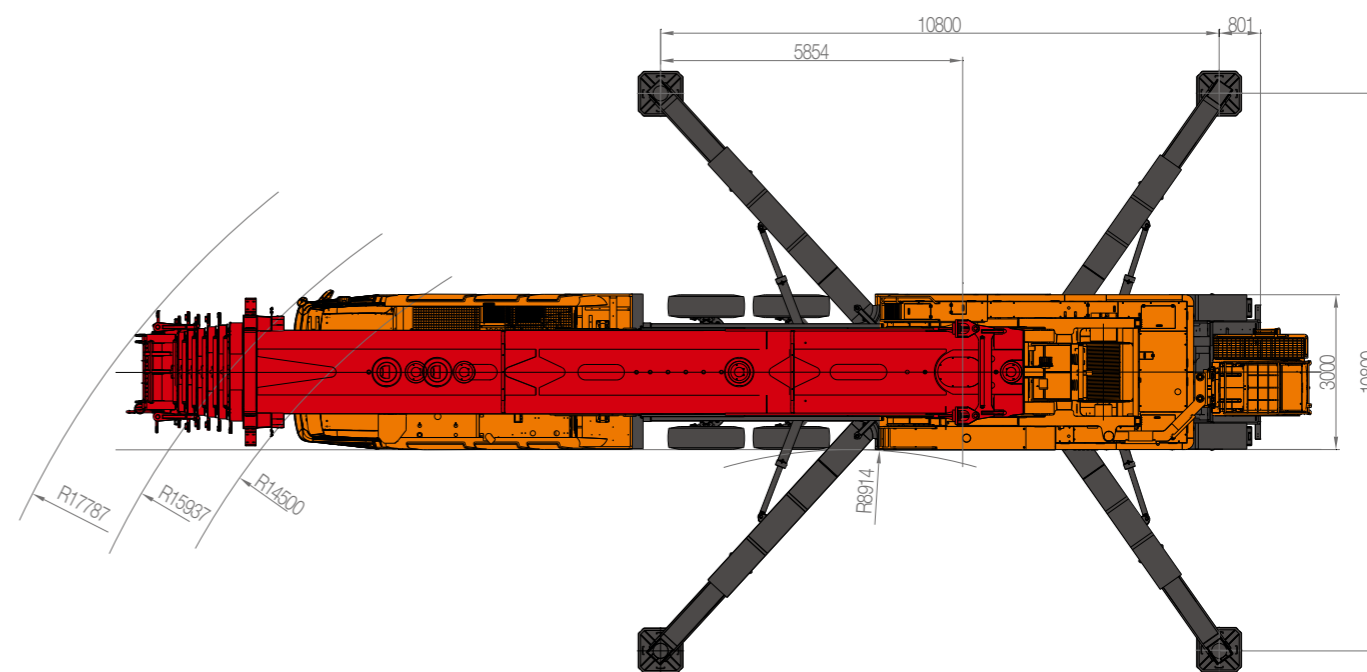
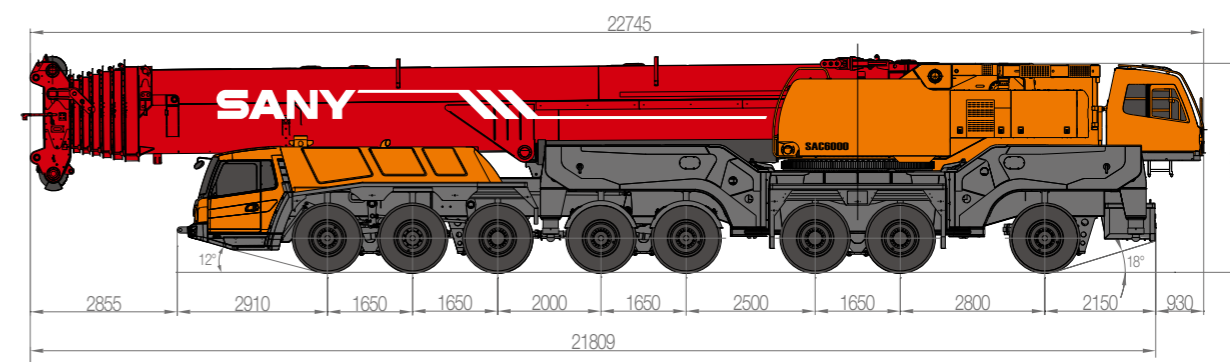

Type	Item	Parameter	
Capacity	Max. lifting capacity	600t	
Dimensions	Overall length	22745mm	
	Overall width	3000mm	
	Overall height	4000mm	
	Axle distance	Axle-1,2	1650mm
		Axle-2,3	1650mm
		Axle-3,4	2000mm
		Axle-4,5	1650mm
Axle-5,6		2500mm	
Axle-6,7	1650mm		
Axle-7,8	2800mm		
Weight	Weight of travelling mode*	96000kg	
	Axle load	Axle load-1,2,3,4	12000kg
		Axle load-5,6,7,8	12000kg
Engine	Rated power (under carriage)	480kW / 1800rpm	
	Rated torque (under carriage)	3000N.m / 1300rpm	
	Rated power (super structure)	205kW / 2200rpm	
	Rated torque (super structure)	1100N.m / 1400rpm	
Traveling	Max.traveling speed	75km/h	
	Turning radius	Min.turning radius	14.5m
		Min.turning radius of boom head	17.8m
	Wheel formula	16 × 8	
	Min.ground clearance	310mm	
	Approach angle (tyre 14.00R25)	12 °	
	Departure angle (tyre 14.00R25)	18 °	
	Max.gradeability	37.4%	
Fuel consumption per 100km	≤ 125L		
Main Performance Data	Temperature range	- 20 ° ~ + 50 °	
	Min.rated range	3 m	
	Tail slewing radius of swingtable	6950 mm	
	Boom section	7	
	Boom shape	U-shaped	
	Max.lifting moment	Base boom	18228 kN·m
		Full-extend boom	11900 kN·m
		Full-extend boom+jib	4025 kN·m
		Full-extend boom+lattice jib	6420 kN·m
	Boom length	Base boom	17.1 m
		Full-extend boom	90 m
		Full-extend boom+jib	128 m
Full-extend boom+lattice jib		(50.6+90) m	
Outrigger span (Longitudinal×Transversal)	10.8 × 10.8 m		
Jib offset	0 °—40°		
Working speed	Max.single rope lifting speed of main winch (no load)	130 m/min	
	Max.single rope lifting speed of auxiliary winch (no load)	130 m/min	
	Full extension/retraction time of boom	1200 / 1200 s	
	Full lifting/descending time of boom	75 / 80 s	
	Slewing speed	0.9 r/min	
Air condition	Superstructure	Cooling/Heating	
	Chassis	Cooling/Heating	

Notes: weight of travelling mode means that the weight without boom of 3,4,5,6,7 section and two rear outriggers.

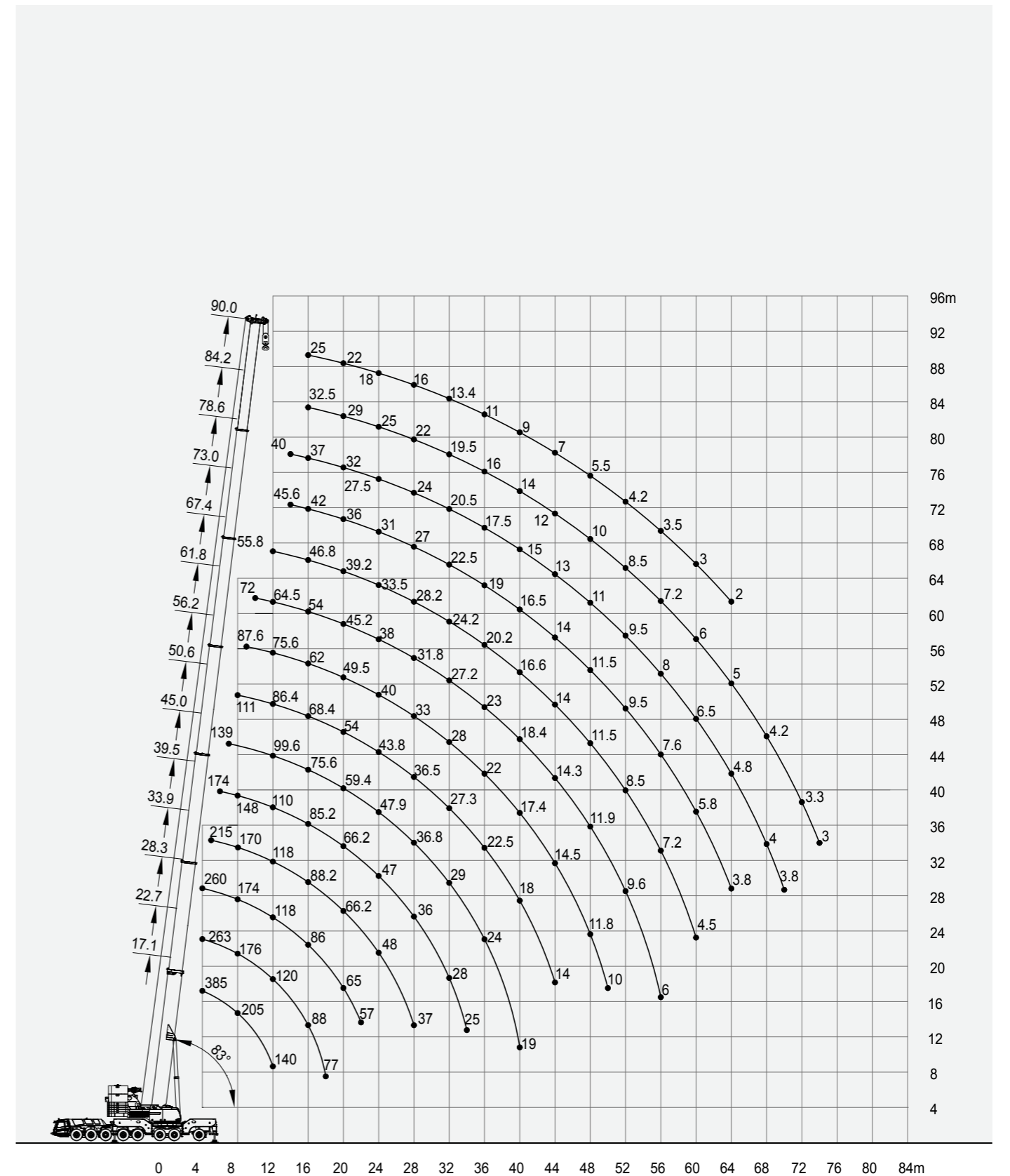

Prerequisites:

- ① Boom operating conditions(fully extended boom length), min.length is 17.1m,max.length is 90m
- ② The span of outriggers is 10.8m×10.8m
- ③ 360°rotation is applied
- ④ Counterweight is 135T

working range	Main boom													
	17.1*	22.7	28.3	33.9	39.5	45	50.6	56.2	61.8	67.4	73	78.6	84.2	90
3	600													
3.5	440	263												
4	385	263	260.4											
4.5	292	262	250.95											
5	288	246	235	219.6										
6	250	220	212	201.6	174									
7	225	196	194	187.2	159.6	139.2								
8	205	176	174	169.8	147.6	128.4	112							
9	190	159	157	154	136.8	120	105	87.6						
10	186	144	142	140.4	127.2	112.8	98	82.8	72					
12	140	120	118	118.5	110.4	99.6	87	75.6	64.5	55.8	49			
14	105	103	101	101.7	96	87.6	76	68.4	59	51.6	45.6	40		
16		88	86	88.2	85.2	75.6	68.4	62	54	46.8	42	37	32.5	25
18		77	75	77.2	77.2	66	60	55	49.5	43	39	34.5	30.5	23
20		66	65	66.2	66.2	59.4	54	49.5	45.2	39.2	36	32	29	21.5
22			57	55.5	55.5	54	48	45	41.5	36.2	33	29.5	27	20
24			51	48	47	47.9	43.8	40	38	33.5	31	27.5	25	18
26				42	40	42	40.8	36	34.2	30.8	28.5	25.5	23.5	17
28				37	36	36.8	37.8	33	31.8	28.2	27	24	22	16
30				32	32	31.8	34.5	30.8	29.2	26	24.5	22	20.5	14.5
32					28	29	31.6	28	27.2	24.2	22.5	20.5	19.5	13.4
34					25	26	28.4	25.3	25	22.2	21	19	17.5	12
36						24	26	22	23	20.2	19	17.5	16	11
38						21	23	19.1	20.9	18.4	18	16.5	15	10
40						19	20.6	17.4	18.4	16.6	16.5	15	14	9
42							18	15.9	16.1	15.2	15.2	14	13	8
44							15.8	14.5	14.3	14	14	13	12	7
46								13.2	13.1	13	12.8	12	11	6
48								11.8	11.9	11.5	11.5	11	10	5.5
50								10	10.8	10	10.2	10	9	5
52									9.6	8.5	9.5	9.5	8.5	4.2
54									8.5	7.8	8.8	9	8	3.8
56									6	7.2	7.6	8	7.2	3.5
58										6.6	6.5	7.5	6.8	3.2
60											5.8	6.5	6	3
62												5.3	5.5	2.5
64													4.8	2
66														4.5
68														4
70														3.8
72														3.3
74														3

Notes: The item with * should be operated at rear side with additional equipment.

Prerequisites:

- ① Boom operating conditions(fully extended boom length), min.length is 17.1m,max.length is 90m
- ② The span of outriggers is 10.8m×10.8m
- ③ 360°rotation is applied
- ④ Counterweight is 105T

working range	Main boom													
	17.1	22.7	28.3	33.9	39.5	45	50.6	56.2	61.8	67.4	73	78.6	84.2	90
3	263													
3.5	263	263												
4	263	263	260.4											
4.5	256	262	245											
5	240	241	240.45	212										
6	216	218	218.4	200.4	174									
7	191	188	199.5	187.2	159.6	139.2								
8	170	168	170	169.8	147.6	128.4	112							
9	154	150	155	154	136.8	120	105	87.6						
10	140	135	143	140.4	127.2	112.8	98	82.8	72					
12	114	112	120	118.5	110.4	99.6	87	75.6	64.5	55.8	49			
14	95	93	96	101.7	96	87.6	76	68.4	59	51.6	45.6	40		
16		79	82	88	85.2	75.6	68.4	62	54	46.8	42	37	32.5	25
18		70.8	72	75	70	66	60	55	49.5	43	39	34.5	30.5	23
20		66	61	63.9	62.4	58	54	49.5	45.2	39.2	36	32	29	21
22			50	53.5	52.1	50	48	45	41.5	36.2	33	29.5	27	20
24			41	45.2	43.8	44	43.8	40	38	33.5	31	27.5	25	18
26				38.4	37	39.4	38.8	36	34.2	30.8	28.5	25.5	23.5	17
28				32.7	31.4	33.7	34	32	31.8	28.2	27	24	22	16
30				28	26.6	28.9	30	29.3	29.2	26	24.5	22	20.5	14.5
32					22.8	24.8	26.5	25.2	25	24.2	22.5	20.5	19.5	13.4
34					20	21.7	23.5	21.6	23.4	22.2	21	19	17.5	12
36						19	20.8	18.6	20.2	18	19	17.5	16	11
38						17	18.5	16.4	17.5	17	18	16.5	15	10
40						15	16.4	15.2	15.3	15.9	16.5	15	14	9
42							14.6	14	13.5	13.7	14	14	13	8
44							12.9	13	12.2	12.1	13	13	12	7
46							11	12	11	10.8	11.6	12.6	11	6
48								11	9.8	10	9.9	11	10	5.5
50								10	8.9	9.2	8.9	9.5	9	5
52									7.8	8.2	7.9	8.1	8.5	4.2
54									6.9	7.8	6.7	7.5	8	3.8
56									6	7.2	5.6	6.5	6.7	3.5
58										6.6	5	6.2	6.3	3.2
60										4.5	4.5	5.5	5.2	2.8
62											4	5	4.6	2.5
64												3.8	4.5	2
66													3.5	4.1

- Prerequisites:
 ① Boom operating conditions (fully extended boom length), min.length is 17.1m, max.length is 90m
 ② The span of outriggers is 10.8m×10.8m
 ③ 360°rotation is applied
 ④ Counterweight is 90T

working range	Main boom													
	17.1	22.7	28.3	33.9	39.5	45	50.6	56.2	61.8	67.4	73	78.6	84.2	90
3	263													
3.5	263	263												
4	263	263	230											
4.5	256	262	230											
5	240	241	223	219.6										
6	216	218	218.4	201.6	174									
7	191	188	199.5	187.2	159.6	139.2								
8	170	168	170	171.6	147.6	128.4	112							
9	154	150	155	158.4	136.8	120	105	87.6						
10	136	135	143	146.4	127.2	112.8	98	82.8	72					
12	108	112	120	115	110.4	99.6	87	75.6	64.5	55.8	49			
14	90	93	96	96	96	87.6	76	68.4	59	51.6	45.6	40		
16		79	81.2	83	81.4	75.6	68.4	62	54	46.8	42	37	32.5	25
18		70.8	65.2	66.9	65.4	65.6	60	55	49.5	43	39	34.5	30.5	23
20		62.5	53.2	54.9	53.4	55.8	54	49.5	45.2	39.2	36	32	29	21.5
22			44.4	45.6	44.1	46.5	45.3	45	41.5	36.2	33	29.5	27	20
24			40.8	38	36.6	39	38.8	39.4	38	33.5	31	27.5	25	18
26				32.5	30.5	32.9	33.6	33.2	34.2	30.8	28.5	25.5	23.5	17
28				28.1	26.3	27.8	29.2	28.1	31.8	28.2	27	24	22	16
30				24.7	24	24.6	25.5	24.1	28.2	26	24.5	22	20.5	14.5
32					22.2	21.5	22.4	21	24.4	22.8	22.5	20.5	19.5	13.4
34					20	18.8	19.6	18.5	21.2	19.5	21	19	17.5	12
36						17.2	17.3	17.2	18.3	17.4	18.3	17.5	16	11
38						16	15.8	16.2	15.8	15.4	15.8	16.5	15	10
40						15	14	15.2	14.5	13.5	14	14.6	14	9
42							13	14	13.2	12	12.8	12.6	13	8
44							12	13	12.2	11.2	11.2	11	12	7
46							11	12	10.8	10.4	9.7	10.1	10.4	6
48								11	9.3	10	8.3	9.1	8.9	5.5
50								10	8	9.2	7.2	8.5	8.1	5
52									7.2	8.2	6.5	7.5	7.5	4.2
54									6.4	7.8	6	6.4	6.3	3.8
56									5.5	7.2	5.5	6	5.2	3.5
58										6.6	5	5.6	4.5	3.2
60										4	4.5	5.1	4	2.5
62											3.9	4.5	3	2.2
64											3.5	3		1.5
66											3.2			

- Prerequisites:
 ① Boom operating conditions (fully extended boom length), min.length is 17.1m, max.length is 90m
 ② The span of outriggers is 10.8m×10.8m
 ③ 360°rotation is applied
 ④ Counterweight is 75T

working range	Main boom													
	17.1	22.7	28.3	33.9	39.5	45	50.6	56.2	61.8	67.4	73	78.6	84.2	90
3	263													
3.5	263	263												
4	263	263	260.4											
4.5	256	262	250.95											
5	240	241	240.45	219.6										
6	218	216	218.4	200.4	174									
7	186	196	199.5	187.2	159.6	139.2								
8	160	179	178.5	169.8	147.6	128.4	112							
9	142	158	160	154	136.8	120	105	87.6						
10	130	140	140	140.4	127.2	112.8	98	82.8	72					
12	102	104	110	112	110.4	99.6	87	75.6	64.5	55.8	49			
14	86	85	89.2	91.1	89.4	87.6	76	68.4	59	51.6	45.6	40		
16		76.8	69.3	71	69.5	69.6	68.4	62	54	46.8	42	37	32.5	25
18		64.6	55	56.7	55.2	57.7	56.4	55	49.5	43	39	34.5	30.5	23
20		53.6	48	46	44.5	47	46	47.3	45.2	39.2	36	32	29	21.5
22			44.4	38.5	37	39	38.8	38.9	41.5	36.2	33	29.5	27	20
24			40.8	33	31.5	33	33.1	32.2	34	33.5	31	27.5	25	18
26				30.2	28	28.6	28.4	26.9	28.5	29.5	28.5	25.5	23.5	17
28				28	26	24.3	24.5	23.2	24	24.9	26.6	24	22	16
30				25	24	21	22	21	21.8	21.1	22.7	22	20.5	14.5
32					22.2	20	20	19.8	19.8	18.4	19.3	20.4	19.5	13.4
34					20	18.5	18.8	18.5	18.5	16.8	16.9	17.5	17.5	12
36						17.2	17	17.2	16.6	15.2	14.9	16	16	10.8
38						16	15.8	16.2	14.3	14.2	13	14.5	13.9	9.8
40						15	14	15.2	12.4	13	12	13	12	8.8
42								12.4	14	11.4	12	11	11.3	7.9
44								11	13	10.4	11.2	10	9.7	7.2
46									12	9.8	10.4	9.2	8.9	6
48									10.7	8.8	9.1	8	8.1	5.5
50									9.4	7.8	8	7	7.4	4.5
52										7.2	7.4	5.9	6.9	3.8
54										6.4	6.9	5.4	5.9	3.5
56										5.8	6.4	5	4	3
58											5.9	4.6	3	
60												4.2		
62												3		

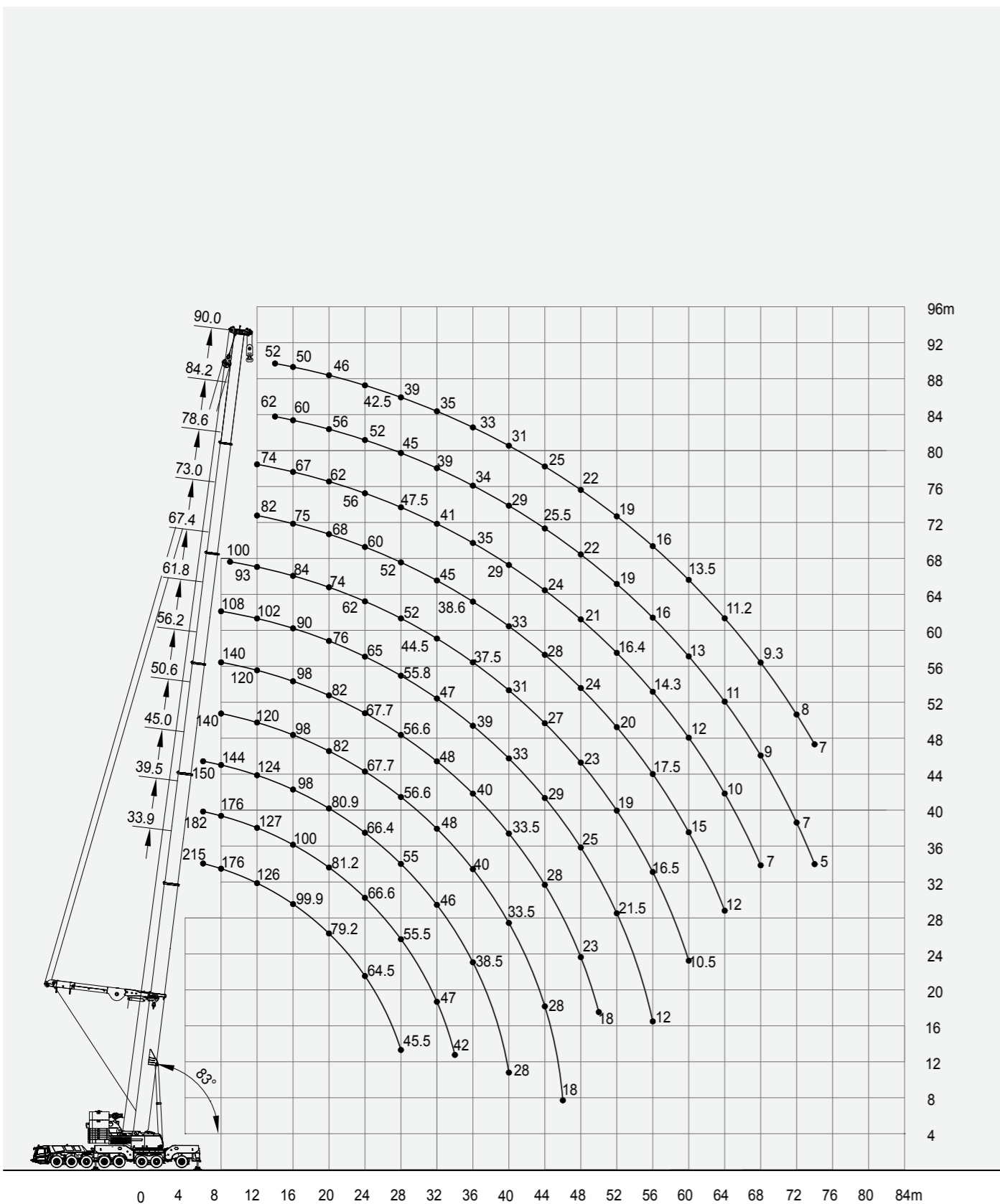

Prerequisites:

- ① Boom operating conditions (fully extended boom length), min. length is 33.9m, max. length is 90m
- ② The span of outriggers is 10.8m x 10.8m
- ③ 360° rotation is applied
- ④ Counterweight is 165T
- ⑤ Superlift angle of one-side unfold is 25°

working range	Main boom + Superlift											
	33.9	39.5	45	50.6	56.2	61.8	67.4	73	78.6	84.2	90	
4.5	225											
5	220											
6	215	182	150									
7	195.2	180	148	149.5								
8	176.5	176.3	144	146	127	108						
9	160.6	160.5	136	142	125	106	100					
10	147	146.9	130	136	122	105	97					
12	125.8	126.8	124	132	115	102	93	82	74			
14	112	112	107.8	122	103	97	87	79	70	62	52	
16	99.9	100	98	110	94	90	84	75	67	60	50	
18	88.6	90.5	90	98	86	84	79	72	65	58	48	
20	79.2	81.2	80.9	87	80	76	74	68	62	56	46	
22	71.3	73.3	73.1	77	73	70	68	63	59	54	44	
24	64.5	66.6	66.4	68.6	66	65	62	60	56	52	42.5	
26	58.6	60.7	60	61.9	59.6	60	58	56	52	49	40.5	
28	53.4	55.5	55	56.6	54.6	55.8	52	52	47.5	45	39	
30	42	51	50	52	50	51	48	48	44	42	37	
32		47	46	48	45.5	47	44.5	45	41	39	35	
34		42	42	44	42	42.5	40.5	41.6	38	36.5	34	
36			38.5	40	39	39	37.5	38.6	35	34	33	
38			35.5	36.5	35	36	35	35.6	32	31.5	32	
40			28	33.5	32	33	31	33	29	29	31	
42				31.5	30	31	29.5	30	26	27	28	
44				28	28	29	27	28	24	25.5	25	
46				22	26	27	25	26	22	24	24	
48					23	25	23	24	21	22	22	
50					18	23	21	22	18.5	20	20.4	
52						21.5	19	20	16.4	19	19	
54						18.5	17.5	18.5	15.3	17	17.2	
56						12	16.5	17.5	14.3	16	16	
58							14.5	16.5	13	14	14.3	
60							10.5	15	12	13	13.5	
62								14	11	12	12.4	
64								12	10	11	11.2	
66									9	10	10.5	
68									7	9	9.3	
70										8	8.4	
72										7	8	
74										5	7	
76											6	
78												

Prerequisites:

- ① Boom operating conditions (fully extended boom length), min.length is 33.9m, max.length is 90m
- ② The span of outriggers is 10.8m×10.8m
- ③ 360° rotation is applied
- ④ Counterweight is 135T
- ⑤ Superlift angle of one-side unfold is 25°

working range	Main boom + Superlift											
	33.9	39.5	45	50.6	56.2	61.8	67.4	73	78.6	84.2	90	
4.5	225	190	138									
5	220	185	152	152								
6	213.7	182	150	149.5	134	110						
7	191.6	180	148	146	130	110	100					
8	173.2	173	144	142	127	108	100					
9	157.6	157.5	136	136	125	106	100	84				
10	144	143.9	130	132	122	105	97	84	74	62	52	
12	122.5	123.6	122.1	122	115	102	93	82	74	62	52	
14	109.3	109.2	104.9	108	103	97	87	79	70	62	52	
16	97.3	97.7	96.7	96	94	90	84	75	67	60	50	
18	86.3	88.1	87.9	87.2	85.3	84	79	72	65	58	48	
20	77.1	79	78.8	80.1	79	76	74	68	62	56	46	
22	69.3	71.3	71.1	72.4	71.3	70	68	63	59	54	44	
24	62.3	64.7	64.5	65.9	64.7	65	62	60	56	52	42.5	
26	55.7	58.2	58	59.5	58.2	59.4	55	55	50	49	40.5	
28	50	52.5	52.3	53.9	52.6	53.9	50	50	46	45	39	
30	42	47.6	47.5	49.1	47.8	49	46	46	42	42	37	
32		43.3	43.2	44.8	43.5	44.8	42	42	38	39	35	
34		39.5	39.5	41.1	38	40	38	38	35	35	34	
36			35	37.8	35	36	34	35	32	32	32	
38			33.1	34.8	32	33	31	32	29	30	29	
40			28	31	30	31	28	30	26	27	26.5	
42				29	27	28	26	27	24	25	25	
44				26	25	26	24	25	22	23	23	
46				18	22.5	24	22	23	20	21	21	
48					21	22	20	21	18	19	19	
50					18	20	18	19	16	17	17	
52						19	16	17.5	14.5	15.5	15.5	
54						17	15	16	13	14	14	
56						12	13	15	12	12.5	12.5	
58							12.5	13.5	10.7	11.5	11.5	
60							10.5	12	9.4	10.8	10.5	
62								11.5	8.1	9.6	9.9	
64								10.3	6.9	8.4	8.7	
66									5.8	7.3	7.6	
68									4.7	6.2	6.6	
70										5.2	5.6	
72										4.3	4.7	
74										3.4	3.8	
76											3	

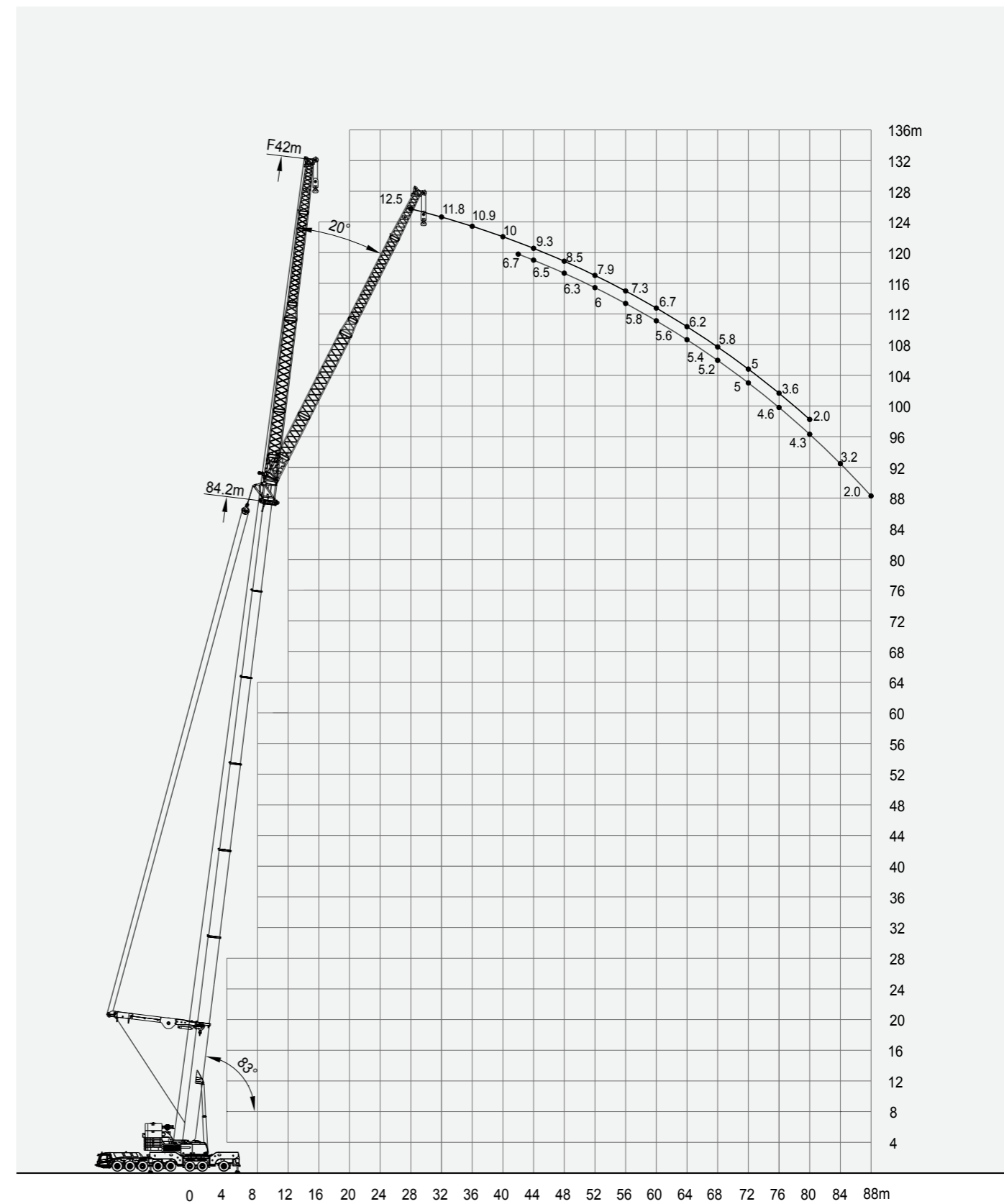

Prerequisites:
 ① Boom operating conditions(boom length+ adapter+ jib length), max.length is 17.1m+2.2m+42m
 ② The span of outriggers is 10.8m×10.8m
 ③ 360°rotation is applied
 ④ Counterweight is 135T

working range	Main boom + Adapter+ Jib																	working range	
	12m			18m			24m			30m			36m			42m			
	0°	20°	40°	0°	20°	40°	0°	20°	40°	0°	20°	40°	0°	20°	40°	0°	20°		
5	73																		5
6	65			50															6
7	58			45.5			49.1			38.0									7
8	52			41			44.2			35.0		28.7							8
9	45.5			37.5			40.4			32.4		26.4					22.4		9
10	41	29.5		34			36.7			29.6		24.5					20.7		10
12	35.5	25.9		28.2			30.4			25.1		21.1					18		12
14	31	23	19.1	24.7	18.5		26.6	19.1		21.7		18.3					15.8		14
16	26.8	20.8	17.6	21.8	16.5		23.5	18.0		19.1	14.0	15.9					13.9		16
18	23.2	18.9	16.2	19.3	14.8		20.8	16.1		17.0	12.7	14.3					12.2		18
20	19.9	17.2	15.2	17.1	13.5	11.7	18.4	14.7	12.2	15.3	11.4	12.9	10.0				11		20
22	17.7	15.7	14.3	15	12.3	10.8	16.2	13.4	11.8	13.6	10.3	11.6	9.0				10		22
24	16.1	14.5	13.5	13.1	11.3	10	14.1	12.3	10.9	12.1	9.4	8.0	10.4	8.1			9.1	6.8	24
26	14.6	13.5	13	11.5	10.4	9.4	12.4	11.3	10.2	10.7	8.7	7.5	9.4	7.3			8.3	6.2	26
28	13.4	12.9		10.5	9.5	8.9	11.3	10.3	9.7	9.4	7.9	6.9	8.4	6.6			7.5	5.6	28
30				9.6	8.8	8.3	10.4	9.5	9.0	8.3	7.3	6.5	7.4	6.1	5.0		6.8	5	30
32				8.8	8.2	8	9.5	8.9	8.7	7.4	6.7	6.1	6.5	5.7	4.6		6.1	4.6	32
34				8.1	7.8		8.7	8.4	8.3	6.8	6.1	5.6	5.6	5.2	4.3		5.4	4.2	34
36							8.1	8.0		6.3	5.6	5.3	5.1	4.8	4.1		4.8	3.9	36
38							7.6			5.7	5.3	5.1	4.7	4.4	3.8		4.1	3.6	38
40										5.2	5.0	4.9	4.4	4.1	3.6		3.7	3.3	40
42										4.9	4.8		4.0	3.8	3.4		3.3	3.1	42
44										4.6	4.6		3.7	3.6	3.2		3.1	2.8	44
46													3.4	3.3	3.1		2.8	2.6	46
48													3.2	3.2	3.0		2.6		48
50													3.0	3.0			2.4		50
52																			52

Prerequisites:
 ① Boom operating conditions(boom length+ adapter+ jib length), max. length is 50.6m+2.2m+42m
 ② The span of outriggers is 10.8m×10.8m
 ③ 360°rotation is applied
 ④ Counterweight is 135T

working range	Main boom + Adapter+ Jib																	working range	
	12m			18m			24m			30m			36m			42m			
	0°	20°	40°	0°	20°	40°	0°	20°	40°	0°	20°	40°	0°	20°	40°	0°	20°		
12	44									32				32.5					12
14	40									29.4				30.7			23.5		14
16	37	25.3								27.2				28.4			21.9		16
18	34.5	23.8								25.2	17.2			26.3	18.0		20.2		18
20	32	22.5	17.5							23.4	16.2			24.4	17.3		18.9		20
22	30	21.3	16.9							21.8	15.3			22.7	16.3		17.6	12.5	22
24	28.3	20.2	16.3							20.4	14.4	11.3		21.3	15.3	12.1	16.4	11.8	24
26	26.7	19.2	15.8							19.3	13.7	10.8		20.1	14.5	11.6	15.3	11.2	26
28	24.9	18.4	15.3							18.3	12.9	10.4		19.1	13.7	11.1	14.5	10.5	28
30	23	17.7	14.8							17.3	12.3	10.1		18.1	13.0	10.8	13.8	9.9	30
32	21.3	17	14.5							16.5	11.8	9.7		17.2	12.5	10.3	13.0	9.4	32
34	19.6	16.3	14.1							15.6	11.3	9.4		16.3	11.9	10.0	12.3	8.9	34
36	18.1	15.7	13.8							14.8	10.8	9.1		15.4	11.4	9.7	11.7	8.5	36
38	16.5	15.1	13.5							13.9	10.4	8.9		14.5	11.0	9.4	11.2	8.0	38
40	14.9	14.6	13.2							13.2	10	8.6		13.8	10.5	9.1	10.6	7.7	40
42	13.4	13.8	13							12.4	9.6	8.4		12.9	10.1	8.9	10.0	7.4	42
44	12.1	12.7	12.8							11.7	9.2	8.2		12.2	9.7	8.7	9.3	7.1	44
46	11.1	11.6	12							10.9	8.9	8.1		11.4	9.4	8.6	8.8	6.8	46
48	10.1	10.6								9.9	8.6	7.9		10.3	9.0	8.3	8.2	6.5	48
50	9.3	9.6								9.1	8.3	7.7		9.5	8.7	8.1	7.7	6.2	50
52	8.4	8.7								8.3	8.0	7.6		8.7	8.4	8.0	7.2	6.0	52
54	7.3	7.9								7.6	7.8	7.6		7.9	8.2	8.0	6.8	5.7	54
56	5.9	6.3								7.0	7.4			7.3	7.8		6.5	5.5	56
58	4.5									5.8	6.7			6.6	7.0		6.2	5.2	58
60	3.3									4.6	5.5			5.5	6.4		5.9	5.1	60
62										3.4	4.1			4.4	5.8		5.2	5.0	62
64										2.3	2.8			3.3	4.6		4.1	4.8	64
66														2.2			3.0	4.7	66
68																	2.1	3.7	68
70																	2.6		70
72																			72
74																			74
76																			76

Prerequisites:

- ① Boom operating conditions(boom length+ adapter+ jib length), max.length is 61.8m+2.2m+42m
- ② The span of outriggers is 10.8m×10.8m
- ③ 360°rotation is applied
- ④ Counterweight is 135T

working range	Main boom + Adapter+ Jib																		working range
	12m			18m			24m			30m			36m			42m			
	0°	20°	40°	0°	20°	40°	0°	20°	40°	0°	20°	40°	0°	20°	40°	0°	20°		
12																			12
14	32.5			26.7			27.0												14
16	29.9			24.8			25.7			19.7									16
18	27.6	24.1		23.3			24.2			18.5		14.2				11.7			18
20	25.5	23		22			22.8			17.4		13.3				11			20
22	23.6	22	16.9	20.5	15.1		21.3	16.0		16.5		12.5			10.3				22
24	21.8	21	16.3	19.1	14.4		19.8	15.2		15.6		11.8			9.7				24
26	20.2	20.1	15.9	17.8	13.7		18.5	14.5		14.7	11.0	11.2			9.2				26
28	18.7	18.9	15.4	16.6	13.1	10.4	17.2	13.8	11.3	14.0	10.4	10.6	7.7		8.7				28
30	17.4	17.6	15	15.4	12.5	10.1	16.0	13.2	10.8	13.3	9.9	10.0	7.4		8.2				30
32	16.2	16.4	14.6	14.3	12	9.8	14.8	12.6	10.4	12.7	9.5	7.0	9.5	7.0	7.8	5.3			32
34	15.1	15.3	14.3	13.3	11.5	9.5	13.8	12.1	10.1	12.0	9.0	6.6	9.0	6.6	7.4	5			34
36	14	14.3	14	12.4	11.1	9.2	12.9	11.7	9.8	11.3	8.5	6.4	8.6	6.3	7	4.8			36
38	13.1	13.3	13.4	11.6	10.7	9	12.0	11.2	9.5	10.5	8.2	6.2	8.2	6.0	4.3	6.6	4.6		38
40	12.1	12.4	12.4	10.8	10.3	8.8	11.2	10.8	9.3	9.8	7.8	6.0	7.8	5.7	4.1	6.3	4.3		40
42	11.2	11.5	11.5	10	10	8.6	10.4	10.5	9.1	9.1	7.5	5.9	7.5	5.4	4.0	6	4.1		42
44	10.3	10.6	10.7	9.3	9.6	8.4	9.7	10.1	8.9	8.5	7.3	5.7	7.2	5.2	3.9	5.7	3.9		44
46	9.4	9.7	9.8	8.6	9	8.2	8.9	9.4	8.6	7.9	7.0	5.5	6.8	5.0	3.8	5.5	3.7		46
48	8.5	8.9	9.1	8	8.3	8.1	8.3	8.7	8.5	7.3	6.8	5.4	6.3	4.8	3.6	5.2	3.6		48
50	7.5	8.1	8.3	7.3	7.7	7.9	7.6	8.0	8.3	6.8	6.5	5.3	5.8	4.6	3.5	5	3.4		50
52	6.7	7.3	7.6	6.6	7.1	7.4	6.9	7.4	7.8	6.2	6.3	5.1	5.4	4.4	3.4	4.7	3.3		52
54	6.1	6.6	6.9	5.9	6.4	6.8	6.1	6.7	7.1	5.7	6.1	5.0	4.9	4.2	3.4	4.4	3.2		54
56	5.5	5.9		5.2	5.8	6.2	5.4	6.1	6.5	5.2	5.9	4.9	4.4	4.1	3.3	4.0	3.0		56
58	5.0	5.3		4.6	5.4	5.7	4.8	5.6	6.0	4.6	5.4	4.8	4.0	4.0	3.2	3.7	2.9		58
60	4.4	4.7		4.1	4.9	5.3	4.3	5.1	5.5	4.1	4.9	4.8	3.6	3.8	3.1	3.3	2.8		60
62	3.4	4.0		3.6	4.4		3.7	4.6		3.6	4.5	4.7	3.2	3.7	3.1	3.0	2.7		62
64	2.4	2.8		3.2	3.8		3.3	4.0		3.1	4.1	4.4	2.8	3.5	3.0	2.7	2.6		64
66		1.7		2.1	3.1		2.7	3.4		2.7	3.6	4.0	2.4	3.3	3.0	2.4	2.5		66
68				2			1.8	2.9		2.3	3.2	3.6	2.0	3.0	2.9	2.0	2.4		68
70								2.2			2.7			2.6	2.9		2.3		70
72											2.3			2.3	2.7		2.1		72
74														1.9	2.3		1.8		74
76															1.9				76

Prerequisites:

- ① Boom operating conditions(boom length+ adapter+ jib length), max.length is 73m+2.2m+42m
- ② The span of outriggers is 10.8m×10.8m
- ③ 360°rotation is applied
- ④ Counterweight is 135T

working range	Main boom + Adapter+ Jib																		working range
	12m			18m			24m			30m			36m			42m			
	0°	20°	40°	0°	20°	40°	0°	20°	40°	0°	20°	40°	0°	20°	40°	0°	20°		
12																			12
14																			14
16	22.3																		16
18	20.6			17.5			18.2			15.0									18
20	19.1	19.1		16.3			16.8			14.1		11.9							20
22	17.8	17.8		15.2			15.7			13.1		11.1			8.7				22
24	16.5	16.7	15.9	14.3	13.5		14.8	14.0		12.3		10.4			8.3				24
26	15.4	15.6	15.4	13.3	13		13.7	13.7		11.5		9.7			7.9				26
28	14.3	14.7	14.7	12.4	12.5		12.8	13.1		10.8	9.7	9.2			7.5				28
30	13.2	13.7	13.9	11.6	11.8	9.8	12.0	12.4	10.4	10.1	9.4	8.6			7.1				30
32	12.2	12.7	13.1	10.8	11.1	9.5	11.2	11.6	10.1	9.5	8.9	8.1	6.5		6.7				32
34	11.3	11.8	12.2	9.9	10.5	9.3	10.2	11.0	9.9	8.8	8.6	7.7	6.3		6.3				34
36	10.5	10.9	11.4	9.2	9.9	9.1	9.5	10.4	9.6	8.1	8.3	6.4	7.2	6.0	6	4.4			36
38	9.7	10.1	10.6	8.5	9.2	8.9	8.8	9.6	9.4	7.5	8.0	6.1	6.7	5.8	5.6	4.2			38
40	8.9	9.3	9.8	7.8	8.5	8.7	8.1	8.9	9.2	6.8	7.7	5.9	6.1	5.5	5.2	4			40
42	8.3	8.6	9	7.2	7.8	8.4	7.4	8.1	8.8	6.2	7.3	5.8	5.6	5.3	3.9	4.8	3.8		42
44	7.6	8	8.3	6.6	7.2	8	6.8	7.5	8.4	5.7	6.9	5.6	5.1	5.0	3.8	4.4	3.7		44
46	7	7.3	7.7	6	6.6	7.4	6.2	6.9	7.8	5.2	6.4	5.5	4.6	4.8	3.7	3.9	3.5		46
48	6.4	6.7	7.1	5.4	6.1	6.8	5.6	6.4	7.1	4.7	5.8	5.3	4.1	4.6	3.6	3.5	3.4		48
50	5.8	6.2	6.4	4.9	5.6	6.3	5.1	5.8	6.6	4.3	5.3	5.2	3.7	4.5	3.5	3.2	3.3		50
52	5.3	5.6	5.9	4.4	5.1	5.7	4.5	5.3	6.0	3.8	4.8	5.0	3.3	4.2	3.4	2.8	3.1		52
54	4.7	5.1	5.3	4	4.6	5.2	4.1	4.8	5.4	3.4	4.4	5.0	3.0	3.8	3.3	2.5	3		54
56	4.2	4.5	4.8	3.5	4.1	4.8	3.6	4.3	5.0	3.0	4.0	4.6	2.6	3.4	3.3	2.1	2.9		56
58	3.7	4.0	4.3	3.1	3.7	4.3	3.2	3.8	4.5	2.6	3.6	4.1	2.3	3.1	3.2		2.7		58
60	3.2	3.6	3.8	2.7	3.3	3.8	2.8	3.4	4.0	2.1	3.2	3.7		2.7	3.1		2.4		60
62	2.8	3.2		2.3	2.9	3.4	2.4	3.0	3.5		2.8	3.3		2.4	3.0		2.1		62
64	2.3	2.7		2.0	2.5	3.0	2.1	2.6	3.1		2.4	2.9		2.0	2.7		1.8		64
66	1.9	2.2			2.1	2.6		2.2	2.7		2.0	2.5			2.3				66
68		1.8				2.2			2.3			2.2			2.0				68
70												1.7							70

SAC6000 ALL-TERRAIN CRANE
LOAD CHART

- Prerequisites:**
- ① Boom operating conditions(boom length+ adapter+ jib length), max.length is 84.2m+2.2m+42m
 - ② The span of outriggers is 10.8m×10.8m
 - ③ 360°rotation is applied
 - ④ Counterweight is 135T

working range	Main boom + Adapter+ Jib																		working range
	12m			18m			24m			30m			36m			42m			
	0°	20°	40°	0°	20°	40°	0°	20°	40°	0°	20°	40°	0°	20°	40°	0°	20°		
12																			12
14																			14
16																			16
18	14.8																		18
20	13.7			11.5			12.0												20
22	12.8			10.7			11.0			9.3									22
24	11.9	12.3		10			10.3			8.5		7.0							24
26	11.2	11.5		9.3			9.6			7.8		6.5			5.2				26
28	10.5	10.7	11.1	8.7	9.3		9.0	9.9		7.3		6.0			4.8				28
30	9.9	10	10.4	8.2	8.7		8.4	9.1		6.8		5.6			4.4				30
32	9.2	9.4	9.7	7.7	8.1		7.9	8.5		6.4	7.2	5.1			4.1				32
34	8.6	8.8	9.1	7.2	7.6	8.1	7.4	7.9	8.9	6.0	6.7		4.7		3.8				34
36	7.8	8.3	8.6	6.8	7.1	7.6	7.0	7.4	8.0	5.6	6.2		4.4	5.1	3.5				36
38	7.2	7.7	8	6.3	6.6	7.1	6.5	6.9	7.5	5.2	5.7		4.1	4.7	3.2				38
40	6.6	7.1	7.5	5.7	6.2	6.6	5.9	6.5	6.9	4.8	5.3	5.7	3.7	4.4		2.9	3.5		40
42	6	6.5	7	5.2	5.8	6.2	5.4	6.0	6.5	4.4	4.9	5.5	3.4	4.0		2.6	3.3		42
44	5.4	5.9	6.6	4.7	5.4	5.8	4.8	5.6	6.1	4.0	4.6	5.1	3.1	3.7			3.1		44
46	4.9	5.4	6	4.3	5	5.4	4.4	5.2	5.7	3.6	4.2	4.7	2.8	3.4	3.5		2.8		46
48	4.4	4.9	5.5	3.9	4.6	5	4.0	4.8	5.2	3.2	3.9	4.4	2.5	3.1	3.5		2.5		48
50	4	4.4	5	3.4	4.1	4.6	3.5	4.3	4.8	2.8	3.6	4.0		2.8	3.3		2.3		50
52	3.5	4	4.5	3	3.7	4.2	3.1	3.8	4.4	2.3	3.2	3.7		2.6	3.1				52
54	3.1	3.5	4	2.7	3.3	3.8	2.8	3.4	4.0		2.9	3.4		2.3	2.8				54
56	2.7	3.1	3.6	2.3	2.9	3.4	2.4	3.0	3.5		2.6	3.1		2.0	2.5				56
58	2.3	2.7	3.2		2.5	3.0		2.6	3.1		2.1	2.8			2.3				58
60		2.3	2.8		2.2	2.6		2.3	2.7			2.5			2.0				60
62		1.9	2.4			2.2			2.3			2.0							62
64			2.0			1.9			2.0										64

SAC6000 ALL-TERRAIN CRANE
LOAD CHART

- Prerequisites:**
- ① Boom operating conditions(boom length+ adapter+ jib length), max.length is 50.6m+2.2m+42m
 - ② The span of outriggers is 10.8m×10.8m
 - ③ 360°rotation is applied
 - ④ Counterweight is 165T
 - ⑤ Superlift angle of one-side unfold is 35°

working range	Main boom + Adapter+ Jib+Superlift																		working range
	12m			18m			24m			30m			36m			42m			
	0°	20°	40°	0°	20°	40°	0°	20°	40°	0°	20°	40°	0°	20°	40°	0°	20°	40°	
12	74			53			55.3												12
14	69			49.5			51.7			39.0									14
16	64	41		46.5			48.5			36.4			28.9			23.7			16
18	61	40		43.5			45.4			33.9			27.0			22.2			18
20	57	38.5	25.7	41	24.7		42.8	26.3		31.8			25.5			20.9			20
22	53	37	25.4	39	24.6		40.7	26.2		30.3			24.0			19.7			22
24	48	36	24.9	37	24.3	15	38.6	25.8	16.2	28.6	16.9		22.8			18.6			24
26	44.5	34.5	24.4	35	23.9	15.2	36.5	25.3	16.3	27.1	16.5		21.6	12.6		17.7			26
28	40.5	33.5	23.9	33.5	23.4	15.4	35.0	24.8	16.3	26.0	16.3		20.4	12.6		16.8			28
30	37	32.5	23.5	32	22.8	15.4	33.4	24.1	16.3	24.7	16.1	9.3	19.5	12.6		15.9	10.6		30
32	33.5	31.5	23.2	30.5	22.1	15.2	31.8	23.3	16.2	23.5	15.9	9.4	18.6	12.6		15.2	10.3		32
34	30.5	31	22.8	29.1	21.4	15	30.4	22.6	16.0	22.4	15.7	9.5	17.8	12.6		14.5	10		34
36	27.3	29.5	22.6	27.8	20.7	14.7	29.0	21.8	15.6	21.5	15.5	9.6	16.9	12.6	7.1	13.9	9.7		36
38	24.5	26.5	22.3	25.8	20.1	14.4	26.9	21.2	15.3	20.6	15.3	9.7	16.2	12.5	7.1	13.2	9.5		38
40	22	23.9	22.1	23.5	19.6	14.1	24.5	20.6	14.9	19.7	15.1	9.7	15.6	12.2	7.2	12.5	9.3		40
42	19.7	21.5	22	21.3	19	13.9	22.2	20.0	14.7	18.8	14.8	9.7	14.9	11.8	7.1	12.1	9.1		42
44	17.7	19.3	20.3	19.2	18.5	13.7	20.0	19.5	14.5	18.1	14.4	9.6	14.3	11.4	7.1	11.6	8.8		44
46	15.8	17.2	18.1	17.3	18.1	13.5	18.1	19.0	14.3	17.5	14.0	9.5	13.7	11.1	7.0	11.1	8.5		46
48	14.1	15.4		15.6	17.6	13.4	16.3	18.5	14.1	16.7	13.6	9.3	13.2	10.7	6.8	10.7	8.1		48
50	12.5	13.7		14.1	16	13.3	14.7	16.8	14.0	15.6	13.2	9.2	12.7	10.4	6.6	10.2	7.8		50
52	11.1	12.1		12.6	14.3	13.2	13.2	15.0	13.9	14.1	12.9	9.0	12.2	10.1	6.5	9.8	7.5		52
54	9.8	10.6		11.3	12.8	13.2	11.8	13.4	13.9	12.7	12.6	8.9	11.5	9.7	6.4	9.4	7.3		54
56	8.5	9.2		10	11.4		10.4	11.9		11.4	12.2	8.9	11.0	9.5	6.2	9	7		56
58	6.4			8.9	10.1		9.3	10.6		10.2	11.9	8.8	10.6	9.2	6.1	8.6	6.8		58
60				7.8	8.9		8.1	9.3		9.1	10.9	8.8	10.0	9.0	6.0	8.1	6.5		60
62				6.8	7.7		7.1	8.1		8.1	9.8		9.0	8.7	6.0	7.7	6.3		62
64				5.1	6.6		5.3	6.9		7.1	8.5		8.0	8.5	5.9	7.5	6.1		64
66							3.3			6.2	7.5		7.1	8.4	5.8	7.2	6		66
68										5.2	6.5		6.0	8.0	5.8	6.9	5.8		68
70										4.1	5.4		4.8	7.0		5.7	5.6		70
72											2.7		3.8	6.0		4.65	5.5		72
74													2.7	4.8		3.6	5.3		74
76													1.8	3.6		2.7	5.2		76
78													2.4			2	4.1		78
80																	3.0		80
82																	2.0		82

Prerequisites:

- ① Boom operating conditions(boom length+ adapter+ jib length), max.length is 61.8m+2.2m+42m
- ② The span of outriggers is 10.8m×10.8m
- ③ 360°rotation is applied
- ④ Counterweight is 165T
- ⑤ Superlift angle of one-side unfold is 35°

working range	Main boom + Adapter+ Jib+Superlift																		working range
	12m			18m			24m			30m			36m			42m			
	0°	20°	40°	0°	20°	40°	0°	20°	40°	0°	20°	40°	0°	20°	40°	0°	20°	40°	
12																			12
14	67																		14
16	64			46.5			48.3			36.3									16
18	59	40.5		44			45.7			34.3		26.3			21.5				18
20	54	39		42			43.6			32.8		25.0			20.4				20
22	48.5	37.5	25.1	39.5	24.7		41.0	26.2		30.7		23.8			19.3				22
24	44.5	36.5	25.1	38	24.7		39.4	26.1		29.4		22.6			18.4				24
26	41	35.5	24.6	36.5	24.7		37.9	26.1		28.1	17.1	21.4			17.6				26
28	38	34.5	24.2	34.5	24.7	14.7	35.8	26.0	15.7	26.9	17.0	20.6			16.7				28
30	35	33.5	23.8	33	24.1	15	34.3	25.4	16.0	25.6	17.0	19.7	12.6		16				30
32	32.5	32.5	23.4	31.5	23.4	15.3	32.7	24.6	16.0	24.7	16.9	9.3	18.8	12.6	15.3				32
34	29.8	31.5	23.1	29.3	22.7	15.2	30.4	23.9	16.0	23.7	16.7	9.5	18.0	12.6	14.6	10.1			34
36	27.1	29	22.9	27.2	22.1	14.9	28.2	23.2	15.8	22.8	16.5	9.7	17.4	12.6	14	10			36
38	24.6	26.8	22.6	25	21.5	14.6	25.9	22.6	15.5	21.9	16.3	9.9	16.7	12.6	6.7	13.5	9.8		38
40	22.4	24.4	22.3	22.8	20.9	14.4	23.7	21.9	15.2	21.1	15.8	9.9	16.1	12.5	6.8	13	9.7		40
42	20.4	22.2	22.2	20.9	20.3	14.2	21.7	21.3	15.0	20.4	15.4	9.9	15.4	12.2	7.0	12.5	9.4		42
44	18.5	20.2	21.4	19.1	19.9	14	19.8	20.8	14.8	19.7	15.0	9.8	14.9	11.9	7.1	12	9.1		44
46	16.7	18.2	19.3	17.4	19.4	13.8	18.1	20.3	14.5	18.2	14.6	9.7	14.4	11.6	7.0	11.5	8.8		46
48	15	16.4	17.4	15.9	18.1	13.6	16.5	18.9	14.3	16.7	14.2	9.5	14.0	11.3	6.9	11.1	8.5		48
50	13.4	14.7	15.6	14.4	16.5	13.5	14.9	17.2	14.2	15.3	13.9	9.4	13.5	10.9	6.8	10.7	8.2		50
52	12	13.2	13.9	13	14.9	13.3	13.5	15.6	14.0	13.9	13.5	9.2	12.9	10.6	6.7	10.4	8		52
54	10.6	11.7	12.4	11.7	13.4	13.3	12.1	14.0	14.0	12.7	13.1	9.1	12.4	10.3	6.5	10	7.7		54
56	9.4	10.4		10.4	12.1	13.2	10.8	12.6	13.8	11.5	12.8	8.9	11.9	10.1	6.4	9.6	7.4		56
58	8.2	9.2		9.3	10.8	11.8	9.7	11.3	12.4	10.3	12.4	8.8	10.9	9.8	6.3	9.3	7.2		58
60	7.2	8		8.2	9.6	10.5	8.5	10.0	11.0	9.2	11.3	8.7	9.9	9.5	6.2	8.9	7		60
62	6.2	6.9		7.2	8.5		7.5	8.9		8.2	10.2	8.6	8.9	9.3	6.1	8.5	6.8		62
64	5.2	5.9		6.2	7.4		6.4	7.7		7.3	9.0	8.6	8.0	9.1	6.0	8.2	6.6		64
66	4.2	4.9		5.4	6.4		5.6	6.7		6.3	8.0	8.5	7.1	8.9	5.9	7.4	6.3		66
68	2.7			4.6	5.5		4.8	5.7		5.4	7.0	8.0	6.3	8.3	5.9	6.6	6.2		68
70				4	4.5		4.2	4.9		4.7	6.0		5.3	7.3	5.8	5.8	6		70
72				2.6	3		3.1	4.2		4.2	5.1		4.2	6.5	5.8	4.8	5.9		72
74				1.5			2.0			3.2	4.5		3.2	5.6	5.7	3.8	5.7		74
76										2.1	3.9		2.3	4.5		2.9	5.6		76
78											2.9			3.5		2.0	4.8		78
80											1.8			2.4			3.75		80
82														1.5			3		82

Prerequisites:

- ① Boom operating conditions(boom length+ adapter+ jib length), max.length is 73m+2.2m+42m
- ② The span of outriggers is 10.8m×10.8m
- ③ 360°rotation is applied
- ④ Counterweight is 165T
- ⑤ Superlift angle of one-side unfold is 35°

working range	Main boom + Adapter+ Jib+Superlift																		working range	
	12m			18m			24m			30m			36m			42m				
	0°	20°	40°	0°	20°	40°	0°	20°	40°	0°	20°	40°	0°	20°	40°	0°	20°	40°		
12																			12	
14																			14	
16																			16	
18	48.5																		18	
20	46			38.5			39.8			29.9									20	
22	43.5			37			38.2			28.7				22.8					22	
24	40.5	36.5		35			36.2			27.6				21.9				17.2	24	
26	38.5	35.5	24.4	33.5	24.7		34.6	26.0		26.5				21.0				16.4	26	
28	35.5	34.5	24	31.5	24.4		32.6	25.7		25.4				20.2				15.8	28	
30	33	33	23.7	30	23.7	14.5	31.0	24.9	15.4	24.5	16.8			19.4				15.2	30	
32	30.5	31.5	23.3	28.4	23.1	15.1	29.4	24.2	16.0	23.7	16.9			18.7				14.6	32	
34	28.2	29.4	23.1	26.9	22.5	15.1	27.8	23.6	16.0	22.9	16.6			18.1	12.6			14	34	
36	26.2	27.4	22.8	25.5	21.9	14.9	26.4	22.9	15.8	22.1	16.4	9.2	17.4	12.6				13.5	36	
38	24.3	25.5	22.6	23.7	21.4	14.6	24.5	22.4	15.4	21.2	16.1	9.5	16.8	12.6				13.1	9.7	38
40	22.3	23.8	22.4	22.2	20.9	14.4	22.9	21.8	15.2	20.4	15.7	9.7	16.3	12.5				12.6	9.6	40
42	20.4	22.2	22.2	20.5	20.4	14.2	21.2	21.3	15.0	19.6	15.3	9.9	15.8	12.2	6.6	12.1	9.3			42
44	18.6	20.3	21.6	18.8	20	14.1	19.4	20.9	14.8	18.8	14.9	9.9	15.3	11.9	6.8	11.8	9.1			44
46	17	18.6	19.8	17.3	19.4	13.9	17.9	20.2	14.6	17.8	14.6	9.7	14.8	11.6	6.9	11.4	8.8			46
48	15.4	16.9	18.1	15.8	18	13.7	16.3	18.8	14.4	16.3	14.3	9.5	14.3	11.3	6.9	11	8.5			48
50	14	15.4	16.5	14.4	16.5	13.6	14.9	17.2	14.3	15.0	13.9	9.4	13.8	11.0	6.8	10.7	8.3			50
52	12.7	14	15	13.2	15.1	13.5	13.6	15.7	14.1	13.7	13.6	9.3	13.2	10.8	6.7	10.3	8.1			52
54	11.4	12.7	13.5	12	13.8	13.4	12.4	14.4	14.0	12.6	13.3	9.1	12.5	10.5	6.6	9.9	7.8			54
56	10	11.4	12.1	10.9	12.6	13.2	11.3	13.1	13.8	11.4	12.9	8.9	11.5	10.3	6.5	9.5	7.6			56
58	8.6	10.2	10.8	9.8	11.5	12.7	10.1	12.0	13.3	10.4	12.6	8.8	10.5	10.0	6.4	9	7.4			58
60	7.5	9	9.6	8.6	10.4	11.4	8.9	10.8	11.9	9.4	11.6	8.7	9.6	9.8	6.3	8.6	7.2			60
62	6.4	7.9		7.4	9.3	10.2	7.6	9.7	10.6	8.5	10.5	8.7	8.7	9.6	6.2	8.2	7			62
64	5.4	6.7		6.3	8.2	9.1	6.5	8.5	9.5	7.7	9.6	8.6	7.8	9.4	6.1	7.8	6.8			64
66	4.3	5.6		5.3	7.2	8	5.5	7.5	8.3	6.7	8.6	8.4	7.1	9.2	6.0	7	6.6			66
68	3.2	4.5		4.4	6.3	7	4.5	6.5	7.3	5.8	7.7	8.0	6.3	8.4	5.9	6.3	6.4			68
70	2.5	3.4		3.5	5.5		3.6	5.7		4.9	6.8	7.5	5.7	7.6	5.9	5.6	6.3			70
72	1.8	2.5		2.6	4.4		2.7	4.6		4.1	5.8	6.9	4.7	6.8	5.8	4.9	6.1			72
74		1.6		1.6	3.4		1.7	3.5		3.3	5.0	5.9	3.6	6.0	5.7	4.1	5.9			74
76					2.4			2.5		2.5	4.4		2.7	5.2	5.7	3.2	5.7			76
78					1.7			1.8			3.6		1.8	4.4	5.6	2.3	5			78
80											2.7			3.3	4.7		4.4			80
82														2.4	4.1		3.3			82

Prerequisites:

- ① Boom operating conditions(boom length+ adapter+ jib length), max.length is 84.2m+2.2m+42m
- ② The span of outriggers is 10.8m×10.8m
- ③ 360°rotation is applied
- ④ Counterweight is 165T
- ⑤ Superlift angle of one-side unfold is 35°

working range	Main boom + Adapter+ Jib+Superlift																		working range
	12m			18m			24m			30m			36m			42m			
	0°	20°	40°	0°	20°	40°	0°	20°	40°	0°	20°	40°	0°	20°	40°	0°	20°	40°	
12																			12
14																			14
16																			16
18																			18
20																			20
22	27.7																		22
24	26.4			22			22.7												24
26	25.3	22.8		21			21.6			17.3									26
28	24.1	21.9		20.1			20.7			16.6			13.9			12.5			28
30	23.1	21.1	19.2	19.3	16.9		19.9	17.7		15.9			13.3			12.3			30
32	22.2	20.3	19	18.5	16.5		19.1	17.3		15.3			12.8			11.8			32
34	21.3	19.5	18.5	17.7	16	11.7	18.2	16.7	12.4	14.6	10.8		12.2			11.3			34
36	20.3	18.9	18	17	15.4	11.7	17.5	16.1	12.3	14.0	10.7		11.7			10.9			36
38	19.3	18.2	17.5	16.3	14.8	11.7	16.8	15.4	12.3	13.5	10.5		11.2	8.2		10.4			38
40	18.3	17.5	16.9	15.7	14.4	11.8	16.2	15.0	12.3	12.9	10.4	7.0	10.8	8.0		10			40
42	17.3	17	16.4	15.1	13.9	11.8	15.6	14.5	12.3	12.3	10.1	7.0	10.4	7.9		9.6	6.7		42
44	16.2	16.4	15.9	14.6	13.4	11.8	15.0	14.0	12.3	11.9	10.0	7.0	9.9	7.7		9.3	6.5		44
46	15.2	15.9	15.4	14	12.9	11.8	14.4	13.4	12.3	11.5	9.8	7.0	9.5	7.6	4.7	8.9	6.4		46
48	14.2	15.3	14.9	13.4	12.5	11.8	13.8	13.0	12.3	11.0	9.7	7.0	9.2	7.5	4.7	8.5	6.3		48
50	13.2	14.6	14.5	12.8	12.1	11.6	13.2	12.6	12.1	10.6	9.6	7.0	8.8	7.4	4.7	8.2	6.1		50
52	12.2	13.6	13.8	12	11.8	11.2	12.4	12.3	11.7	10.2	9.3	7.1	8.5	7.3	4.8	7.9	6		52
54	11.2	12.6	13	11.2	11.4	10.9	11.5	11.8	11.4	9.8	9.0	7.1	8.2	7.2	4.8	7.6	5.9		54
56	10.2	11.6	12.1	10.3	10.8	10.6	10.6	11.2	11.1	9.1	8.7	7.1	7.8	7.0	4.8	7.3	5.8		56
58	9.1	10.7	11.3	9.5	10.3	10.3	9.8	10.7	10.7	8.4	8.4	7.1	7.5	6.9	4.8	7	5.7		58
60	8	9.6	10.4	8.7	9.7	9.8	9.0	10.1	10.2	7.6	8.2	7.1	7.0	6.7	4.8	6.7	5.6		60
62	6.9	8.4	9.2	7.7	9.1	9.4	7.9	9.4	9.8	6.9	7.8	7.1	6.6	6.5	4.8	6.5	5.5		62
64	5.8	7.3	8	6.8	8.5	9	7.0	8.8	9.4	6.3	7.3	7.0	6.1	6.3	4.9	6.2	5.4		64
66	4.7	6.1	6.8	5.8	7.7	8.5	6.0	8.0	8.8	5.6	6.8	6.8	5.6	6.2	4.9	6	5.3		66
68	3.8	5	5.6	4.9	6.7	7.7	5.0	6.9	8.0	4.8	6.3	6.6	5.1	5.9	4.9	5.8	5.2		68
70	3.1	4		3.9	5.7	6.7	4.0	5.9	7.0	4.1	5.9	6.2	4.6	5.6	4.9	5.5	5.1		70
72	2.3	3.1		3	4.8	5.6	3.1	5.0	5.8	3.4	5.3	6.0	3.9	5.3	4.8	5	5		72
74		2.2		2.5	3.8	4.6	2.6	3.9	4.8	2.5	4.5	5.5	3.2	5.0	4.7	4.4	4.8		74
76				2	3		2.1	3.1		1.8	3.7	4.7	2.5	4.7	4.6	3.6	4.6		76
78					2.4			2.5			3.0	3.9	1.9	4.3	4.4	2.7	4.5		78
80					1.8			1.9			2.1	3.1		3.6	4.3	2.0	4.3		80
82											2.2			2.9	3.7		4.1		82
84														2.3	3.0		3.2		84
86														1.6	2.4		2.5		86
88														1.8					88

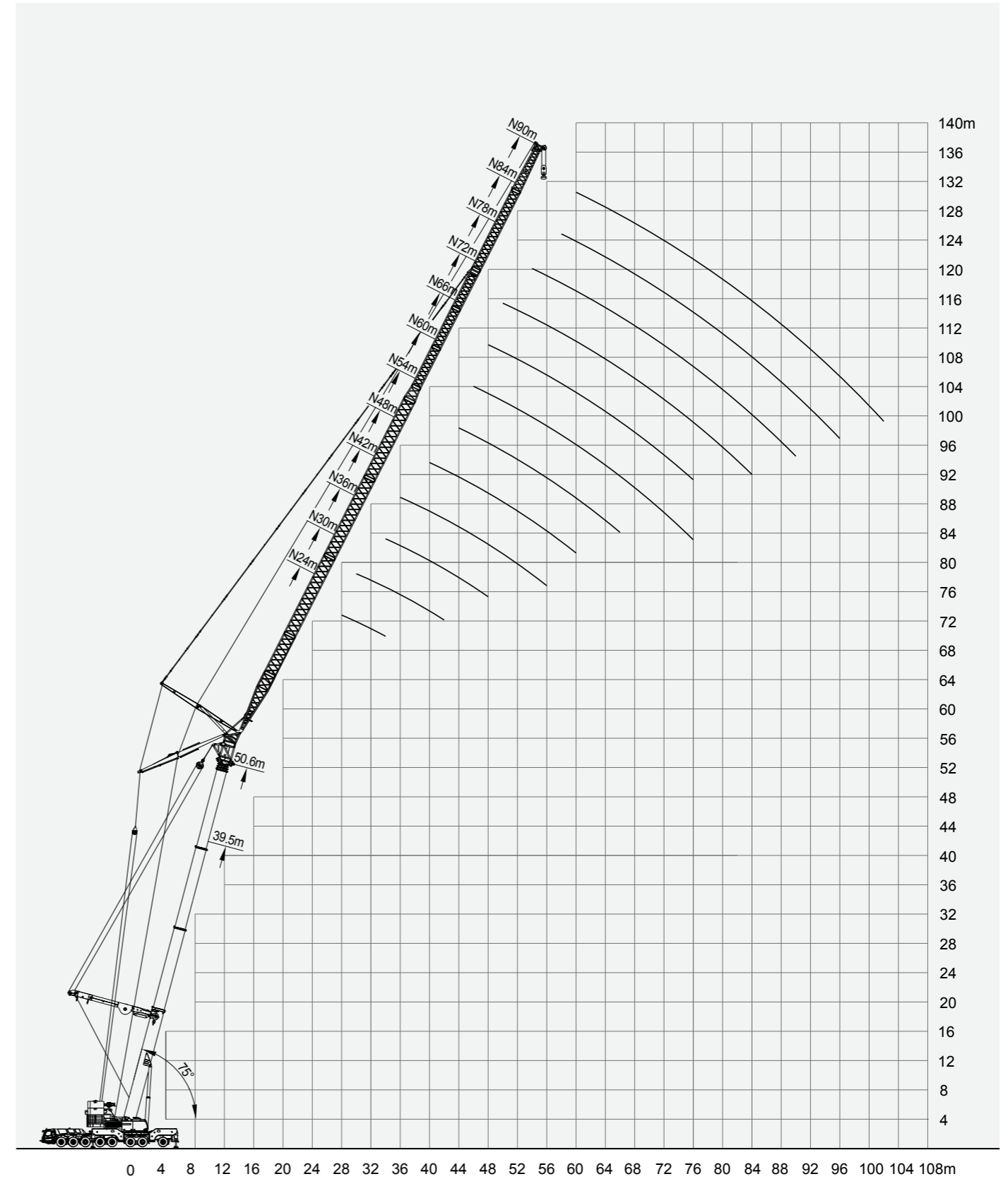

Prerequisites:
 ① Boom operating conditions(fully extended boom length+ adapter+ tower jib length), max.length is 39.5m+2.2m+90m
 ② The span of outriggers is 10.8m×10.8m
 ③ 360°rotation is applied
 ④ Counterweight is 165T
 ⑤ Superlift angle of one-side unfold is 45°
 ⑥ Angle of main boom is 83°

Prerequisites:
 ① Boom operating conditions(fully extended boom length+ adapter+ tower jib length), max.length is 50.6m+2.2m+90m
 ② The span of outriggers is 10.8m×10.8m
 ③ 360°rotation is applied
 ④ Counterweight is 165T
 ⑤ Superlift angle of one-side unfold is 45°
 ⑥ Angle of main boom is 83°

working range	Main boom+ Adapter+ Tower jib+Superlift																			
	24	30	36	42	48	54	60	66	72	78	84	90								
16	87.0																			
18	83.0	78.9																		
20	79.4	73.6	69.4																	
22	74.0	69.4	65.2	58.8																
24	68.5	64.1	61.1	56.7	47															
26	61.9	60.9	57.9	54.7	46	37														
28		56.6	54.8	52.6	45	36.5	30													
30		52.9	51.2	49.5	44.5	35.5	29.7	31.2												
32		48.7	48.1	46.5	43.5	35	29.4	30.8	24.6											
34			44.9	43.4	42	34.5	29	30.4	23.8	20.6										
36			42.4	40.9	40	34	28.7	30.1	23.0	20.3	15.7									
38			39.8	38.3	37.5	33.5	28.4	29.8	22.4	20.0	15.3	13.3								
40				36.3	35	32.5	28.2	29.6	21.8	19.7	14.8	13.2								
42				34.3	33.5	32	27.9	29.3	21.2	19.2	14.4	12.8								
44				32.2	31.5	31	27.6	28.9	20.5	18.7	14	12.4								
46				30.0	29.8	29.4	27.3	28.6	19.9	18.3	13.6	12.1								
48					28.3	27.9	27.1	28.4	19.3	18.0	13.3	11.8								
50						27	26.6	26.1	27.4	18.8	17.6	12.9	11.5							
52							25.3	24.8	26.0	18.4	17.3	12.6	11.2							
54							24.1	23.6	24.7	17.9	16.9	12.3	10.9							
56							23	22.5	23.6	17.6	16.6	11.9	10.7							
58								21.5	22.5	17.2	16.3	11.6	10.4							
60								20.6	21.6	16.9	16.0	11.4	10.1							
62								19.7	20.7	16.5	15.7	11.1	9.9							
64								18.9	19.8	16.2	15.5	10.9	9.7							
66								17.4	18.2	16.0	15.1	10.7	9.5							
68									15.2	15.8	14.9	10.4	9.3							
70										15.6	14.7	10.2	9.2							
72											15.2	14.4	10	9						
74												12.9	14.3	9.8	8.9					
76													14.1	9.6	8.7					
78														13.5	9.5	8.6				
80															11.7	9.3	8.4			
82																9.2	8.3			
84																	9.1	8.2		
86																		9.1	8.1	
88																			8	
90																				7.9
92																				7.9
94																				

working range	Main boom+ Adapter+ Tower jib+Superlift																		
	24	30	36	42	48	54	60	66	72	78	84	90							
16																			
18	79.9																		
20	73.5	67.2																	
22	68.1	64.0	57.1																
24	64.9	59.8	53.9	47.8															
26	61.7	55.5	51.8	45.7	40														
28	55.0	52.9	49.2	44.1	39	31.5													
30		50.2	46.1	42.6	37.5	31.5	25.3												
32		47.6	44.0	41.0	36.5	31.5	25.3	26.6											
34		44.9	41.9	39.0	35.5	31.5	25.3	26.6	20.9										
36			39.8	36.9	34.5	31	25.3	26.6	20.9	16.7									
38			37.7	35.4	33	30	25.3	26.6	20.9	16.6	13								
40				35.7	34.3	31.5	29.3	25.2	26.4	20.9	16.6	13	9.9						
42				34.0	32.3	30.5	28.6	24.9	26.1	20.6	16.6	13	9.9						
44					30.8	29.5	27.6	24.5	25.7	19.9	16.6	13	9.9						
46					29.0	28	26.7	24.2	25.4	19.4	16.6	12.8	9.9						
48					27.5	26.6	25.9	23.4	24.6	18.9	16.6	12.5	9.9						
50						25.3	24.8	22.5	23.6	18.5	16.6	12.3	9.9						
52						24.1	23.6	21.7	22.8	18.0	16.6	12	9.9						
54							22.5	20.9	21.9	17.7	16.4	11.8	9.9						
56								21.5	20.1	21.1	17.3	16.1	11.6	9.9					
58								20.5	19.3	20.2	17.0	15.8	11.4	9.9					
60									18.6	19.5	16.7	15.6	11.1	9.9					
62									17.9	18.8	16.4	15.3	10.9	9.9					
64									17.3	18.1	15.8	14.7	10.7	9.8					
66									16.7	17.5	15.3	14.1	10.5	9.7					
68									16.1	16.9	14.8	13.6	10.3	9.5					
70										16.1	14.2	13.1	10.1	9.3					
72											13.8	12.6	9.9	9.1					
74												13.6	12.2	9.7	8.7				
76												13.4	11.8	9.5	8.3				
78													11.5	9.4	8				
80														11.3	9.2	7.6			
82														11.1	9.1	7.3			
84															8.8	6.9			
86																8.6	6.6		
88																	8.5	6.4	
90																			6.1
92																			5.9
94																			5.7

Prerequisites:
 ① Boom operating conditions(boom length+adapter+ tower jib length), max.length is 61.8m+2.2m+84m
 ② The span of outriggers is 10.8m×10.8m
 ③ 360°rotation is applied
 ④ Counterweight is 165T
 ⑤ Superlift angle of one-side unfold is 45°
 ⑥ Angle of main boom is 83°

Prerequisites:
 ① Boom operating conditions(boom length+adapter+ tower jib length), max.length is 61.8m+2.2m+84m
 ② The span of outriggers is 10.8m×10.8m
 ③ 360°rotation is applied
 ④ Counterweight is 165T
 ⑤ Superlift angle of one-side unfold is 45°
 ⑥ Angle of main boom is 83°

working range	Main boom+ Adapter+ Tower jib+Superlift														
	24	30	36	42	48	54	60	66	72	78	84				
20	58.8														
22	55.1	50.7													
24	51.9	48.0	44.2												
26	48.6	44.9	42.1	36.7											
28	45.4	42.2	40.0	35.1											
30		40.1	37.9	34.1	29.1										
32		37.4	35.8	32.5	28.4	23.2									
34		35.3	33.7	31.5	27.3	23.2	17.3	18.2							
36		33.0	32.1	30.1	26.4	23.1	17.3	18.2	13.4						
38			30.4	29.0	25.5	22.7	17.4	18.3	13.5	10.0					
40			28.8	27.6	24.6	22.1	17.4	18.3	13.5	10.0	7.2				
42			27.0	26.2	23.8	21.4	17.4	18.3	13.5	10.0	7.3				
44				25.0	22.9	20.8	17.4	18.3	13.4	10.0	7.3				
46				23.8	21.8	20.2	17.4	18.3	13.4	10.0	7.3				
48				22.3	20.8	19.6	16.9	17.7	13.4	10.0	7.3				
50				21.0	19.9	18.9	16.3	17.1	13.4	10.0	7.3				
52					19	18.2	15.6	16.4	13.4	10.0	7.3				
54						18.3	17.4	14.9	15.6	12.9	10.0	7.3			
56							16.7	14.3	15.0	12.3	10.0	7.3			
58							16	13.7	14.4	11.7	10.0	7.3			
60								15.3	13.1	13.7	11.2	9.6	7.3		
62									12.5	13.1	10.6	9.1	7		
64									11.9	12.5	10.1	8.6	6.6		
66									11.4	12.0	9.6	8.2	6.2		
68									11	11.5	9.1	7.7	5.9		
70									10.6	11.1	8.7	7.3	5.6		
72											8.3	6.9	5.3		
74											7.8	6.5	5		
76											7.6	6.1	4.7		
78											7.1	5.8	4.4		
80												5.5	4.1		
82												5.3	3.9		
84												5.1	3.7		
86													3.5		
88														3.3	
90															3.2

working range	Main Boom + Adapter + Towr jib + Superlift						
	24	30	36	42	48	54	60
20							
22	43.7						
24	41.7	35.2					
26	39.0	33.6	29.8				
28	36.8	31.7	28.3				
30	33.0	30.1	26.9	23.8			
32		28.6	25.6	22.6	19.4		
34		27.3	24.4	21.7	18.7	14.0	
36		26.0					

- Prerequisites:**
- ① Boom operating conditions(boom length+ adapter+ tower jib length), max.length is 84.2m+2.2m+42m
 - ② The span of outriggers is 10.8m×10.8m
 - ③ 360°rotation is applied
 - ④ Counterweight is 165T
 - ⑤ Superlift angle of one-side unfold is 45°
 - ⑥ Angle of main boom is 83°

working range	Main boom+ Adapter+ Tower jib+Superlift			
	24	30	36	42
20				
22				
24	27.2			
26	25.6	20.1		
28	24.2	20.1		
30		19.0	16.2	
32		18.1	15.3	13.2
34			14.4	12.4
36			13.7	11.7
38			13.0	11.1
40				10.5
42				10.0
44				9.3
46				
48				
50				
52				
54				
56				
58				
60				
62				
64				
66				
68				
70				
72				
74				
76				
78				
80				
82				
84				
86				
88				
90				

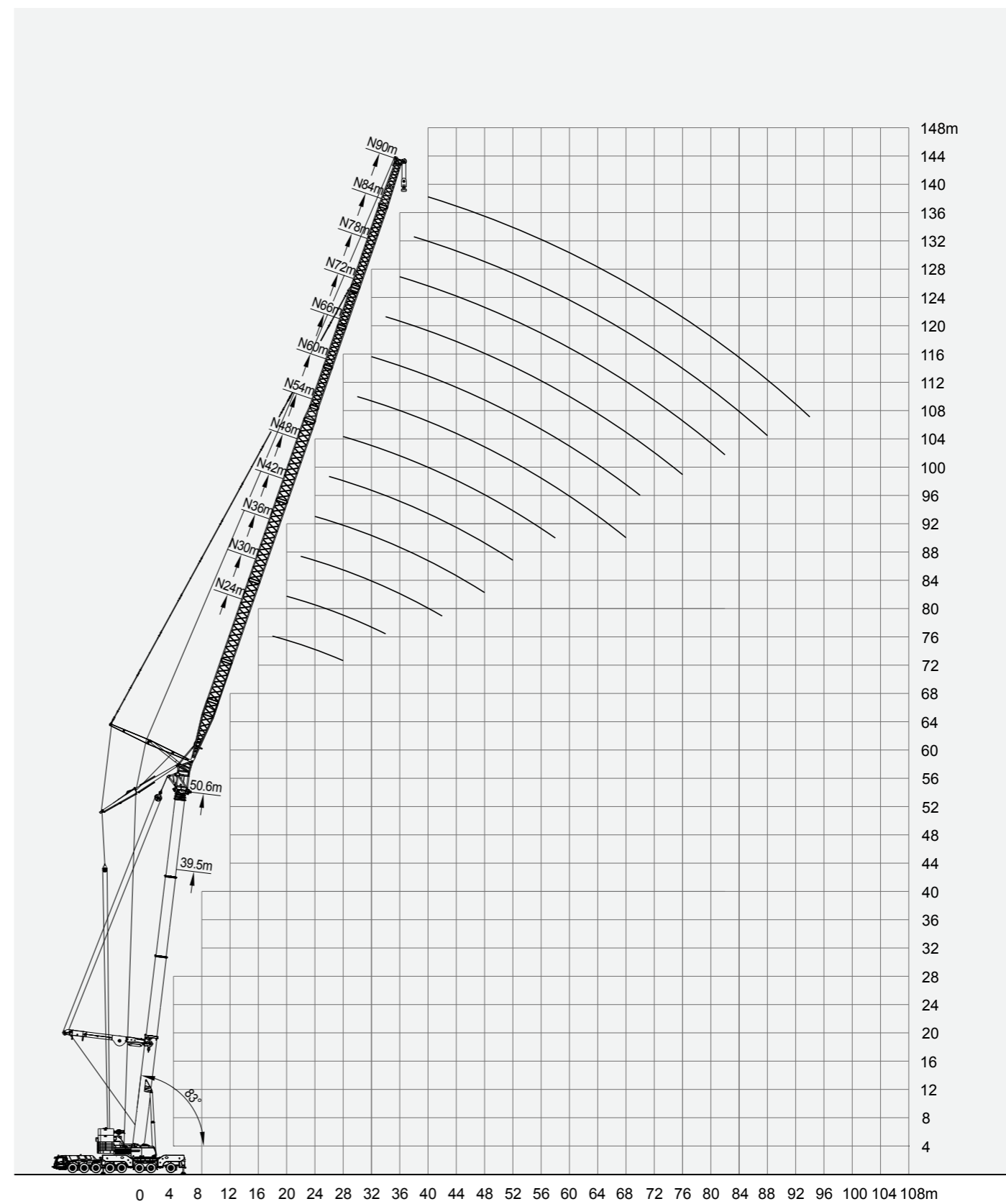

- Prerequisites:**
- ① Boom operating conditions(boom length+ adapter+ tower jib length), max.length is 39.5m+2.2m+90m
 - ② The span of outriggers is 10.8m×10.8m
 - ③ 360°rotation is applied
 - ④ Counterweight is 165T
 - ⑤ Superlift angle of one-side unfold is 45°
 - ⑥ Angle of main boom is 75°

working range	Main boom+ Adapter+ Tower jib+Superlift													
	24	30	36	42	48	54	60	66	72	78	84	90	90	90
24	62.9													
26	57.6													
28	53.8	50.7												
30	50.1	46.9	45.2											
32	45.0	43.8	42.1											
34		41.1	39.5	37.7										
36		38.5	36.9	35.7	34									
38		36.3	34.2	33.1	32									
40			32.7	31.5	30	29.7								
42			30.7	29.5	28.5	28	27.3							
44			29.0	27.9	26.9	26.4	25.8	27.1						
46			28.0	26.4	25.4	25	24.4	25.6						
48				25.0	24.1	23.7	23.1	24.3	20.9					
50				23.8	22.9	22.4	21.9	23.0	20.4	18.9				
52				22.6	21.8	21.3	20.7	21.7	19.9	18.5	13.5			
54					20.7	20.3	19.7	20.7	19.4	18.1	13.1			
56					19.8	19.3	18.8	19.7	18.8	17.7	12.8	11.1		
58						18.4	17.9	18.8	18.2	17.3	12.5	10.9		
60						17.6	17.1	18.0	17.3	16.5	12.2	10.7		
62						16.8	16.3	17.1	16.4	15.6	11.9	10.4		
64							15.6	16.4	15.7	14.9	11.6	10.2		
66							14.9	15.6	15.0	14.2	11.4	10		
68							14.2	14.9	14.4	13.6	11.1	9.8		
70							13.6	14.3	13.7	13.0	10.9	9.7		
72							13.1	13.8	13.1	12.3	10.7	9.5		
74								13.1	12.6	11.7	10.5	9.3		
76									12.0	11.2	10.3	9.1		
78									11.6	10.7	10	9		
80									11.1	10.3	9.6	8.9		
82										9.9	9.2	8.6		
84										9.4	8.7	8.2		
86										9.0	8.3	7.8		
88											8	7.5		
90											7.6	7.1		
92											7.3	6.8		
94												6.4		
96												6.1		
98													5.8	
100														5.8
102														5.8

- Prerequisites:**
- ① Boom operating conditions(boom length+ adapter+ tower jib length), max.length is 50.6m+2.2m+90m
 - ② The span of outriggers is 10.8m×10.8m
 - ③ 360°rotation is applied
 - ④ Counterweight is 165T
 - ⑤ Superlift angle of one-side unfold is 45°
 - ⑥ Angle of main boom is 75°

working range	Main boom+ Adapter+ Tower jib+Superlift													
	24	30	36	42	48	54	60	66	72	78	84	90	90	90
24														
26														
28	48.5													
30	45.3	43.2												
32	42.7	40.0												
34	40.0	37.4	35.4											
36		35.2	33.3	32.3										
38		33.1	31.2	30.2										
40		31.0	29.4	28.4	26.9									
42		29.0	27.8	26.7	25.4									
44			26.2	25.2	23.9	23.4								
46			24.8	23.8	22.6	22.1	21.4							
48			23.6	22.6	21.4	20.9	20.2	21.2						
50				21.5	20.3	19.8	19.2	20.2	18.8					
52				20.3	19.3	18.8	18.1	19.0	17.9					
54				19.4	18.3	17.8	17.2	18.1	17.1	15.9				
56				18.5	17.4	17	16.3	17.1	16.3	15.2				
58					16.6	16.1	15.5	16.3	15.5	14.4	12.2			
60					15.8	15.4	14.8	15.6	14.8	13.8	12	9.8		
62						14.7	14.1	14.8	14.2	13.2	11.5	9.3		
64						14	13.4	14.1	13.6	12.6	11	8.9		
66							13.3	12.8	13.4	12.9	12.1	10.5	8.4	
68								12.2	12.8	12.3	11.5	10	7.9	
70								11.6	12.2	11.7	10.9	9.6	7.5	
72								11.1	11.7	11.2	10.3	9.2	7.1	
74								10.6	11.1	10.7	9.9	8.8	6.7	
76								10.2	10.7	10.1	9.4	8.4	6.4	
78									9.7	8.9	8	6.1		
80										9.3	8.5	7.7	5.8	
82										8.9	8.1	7.3	5.5	
84										8.2	7.8	7	5.2	
86											7.4	6.6	5	
88											7.0	6.3	4.7	
90											6.6	6	4.5	
92												5.7	4.2	
94												5.4	4	
96												5.1	3.8	
98													3.6	
100													3.5	
102													3.3	

- Prerequisites:**
- ① Boom operating conditions(boom length+ adapter+ tower jib length), max.length is 61.8m+2.2m+84m
 - ② The span of outriggers is 10.8m×10.8m
 - ③ 360°rotation is applied
 - ④ Counterweight is 165T
 - ⑤ Superlift angle of one-side unfold is 45°
 - ⑥ Angle of main boom is 75°

working range	Main boom+ Adapter+ Tower jib+Superlift																			
	24	30	36	42	48	54	60	66	72	78	84	84	84							
30	38.5																			
32	36.4																			
34	34.2	32.6																		
36	32.7	30.6																		
38		29.1	27.8																	
40		27.7	26.3	24.6																
42		26.4	25.0	23.3																
44		25.6	23.9	22.1	19.3															
46			22.8	21.0	18.3															
48			21.5	20.0	17.4	16.4														
50			20.5	19.1	16.6	15.6	13	13.7												
52				18.3	15.8	14.8	12.3	12.9												
54				17.4	15.1	14	11.6	12.2	9.7											
56				16.7	14.4	13.4	11	11.6	9.0											
58				16.0	13.8	12.8	10.4	10.9	8.5	6.8										
60					13.2	12.2	9.8	10.3	8.0	6.4	4.3									
62					12.6	11.7	9.3	9.8	7.5	6.0	4									
64						11.1	8.8	9.3	7.1	5.5	3.8									
66						10.6	8.4	8.8	6.6	5.1	3.5									
68						10.1	7.9	8.3	6.3	4.7	3.2									
70							7.5	7.9	5.9	4.5	3									
72								7.1	5.6	4.2	2.8									
74									6.7	5.3	4.0	2.6								
76										6.4	5.0	3.8	2.4							
78											6.1	4.7	3.5	2.2						
80												4.4	3.3	2						
82													4.1	3.1	1.8					
84														3.9	2.9	1.6				
86															3.7	2.7	1.5			
88																	2.5	1.3		
90																		2.4	1.1	
92																			2.2	1

- Prerequisites:**
- ① Boom operating conditions(boom length+ adapter+ tower jib length), max.length is 73m+2.2m+60m
 - ② The span of outriggers is 10.8m×10.8m
 - ③ 360°rotation is applied
 - ④ Counterweight is 165T
 - ⑤ Superlift angle of one-side unfold is 45°
 - ⑥ Angle of main boom is 75°

working range	Main boom+ Adapter+ Tower jib+Superlift						
	24	30	36	42	48	54	60
30							
32							
34	28.9						
36	27.2						
38	25.8	22.4					
40	23.4	21.4					
42		20.3	18.4				
44		19.3	17.5				
46		18.5	16.6	14.9			
48			15.7	14.2	12.1		
50			15.0	13.3	11.5		
52			14.3	12.7	10.9	7.7	
54			13.7	12.1	10.3	7.2	4.1
56				11.4	9.8	6.7	3.8
58				10.8	9.3	6.2	3.5
60				10.3	8.8	5.8	3.3
62					8.4	5.5	3
64					7.9	5.2	2.8
66					7.5	4.9	2.6
68							

- Prerequisites:**
- ① Boom operating conditions(boom length+ adapter+ tower jib length), max.length is 84.2m+2.2m+42m
 - ② The span of outriggers is 10.8m×10.8m
 - ③ 360°rotation is applied
 - ④ Counterweight is 165T
 - ⑤ Superlift angle of one-side unfold is 45°
 - ⑥ Angle of main boom is 75°

working range	Main boom+ Adapter+ Tower jib+Superlift			
	24	30	36	42
30				
32				
34				
36				
38	16.6			
40	15.9			
42		11.8		
44		11.2		
46		10.7	8.8	
48			8.3	
50			7.8	6.0
52				5.5
54				5.1
56				4.8
58				
60				
62				
64				
66				
68				
70				
72				
74				
76				
78				
80				
82				
84				
86				
88				
90				
92				

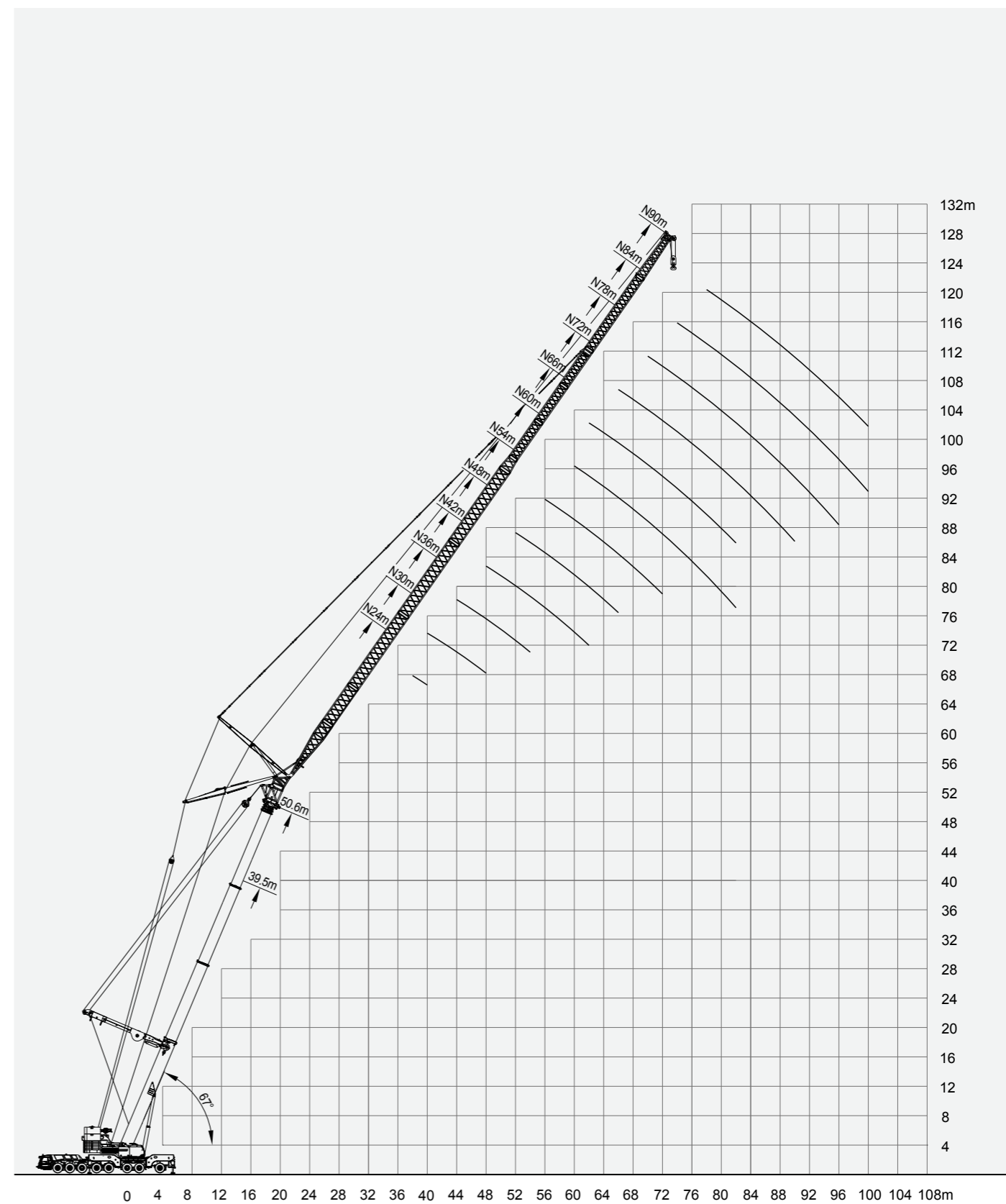

Prerequisites:

- ① Boom operating conditions (fully extended boom length+ adapter+ tower jib length), max.length is 39.5m+2.2m+90m
- ② The span of outriggers is 10.8m×10.8m
- ③ 360°rotation is applied
- ④ Counterweight is 165T
- ⑤ Superlift angle of one-side unfold is 45°
- ⑥ Angle of main boom is 67°

Prerequisites:

- ① Boom operating conditions (fully extended boom length+ adapter+ tower jib length), max.length is 50.6m+2.2m+90m
- ② The span of outriggers is 10.8m×10.8m
- ③ 360°rotation is applied
- ④ Counterweight is 165T
- ⑤ Superlift angle of one-side unfold is 45°
- ⑥ Angle of main boom is 67°

working range	Main boom+ Adapter+ Tower jib+Superlift											
	24	30	36	42	48	54	60	66	72	78	84	90
32	40.7											
34	38.1											
36	35.9	33.6										
38		31.5										
40		29.7	28.1									
42		28.0	26.5									
44		26.5	25.1	24.0								
46			23.7	22.7								
48			22.5	21.5	20.4							
50			21.0	20.4	19.4							
52				19.4	18.4	17.9						
54				18.4	17.5	17						
56				17.5	16.6	16.1	15.5					
58				16.7	15.8	15.3	14.7	15.5				
60					15.1	14.6	14	14.7				
62					14.4	13.9	13.3	14.0	13.5			
64						13.2	12.7	13.3	12.8	12.0		
66						12.6	12.1	12.7	12.1	11.4		
68						12.1	11.5	12.1	11.5	10.8	9.9	
70							11	11.6	11.0	10.2	9.4	
72							10.5	11.0	10.5	9.7	8.9	8.4
74							10	10.5	9.9	9.2	8.4	7.9
76							9.6	10.1	9.5	8.7	8	7.5
78							9.1	9.6	9.1	8.3	7.6	7
80									8.7	7.9	7.2	6.6
82									8.3	7.5	6.8	6.3
84									7.9	7.2	6.5	5.9
86									7.6	6.7	6.1	5.6
88										6.4	5.8	5.2
90										6.1	5.5	5
92										5.8	5.2	4.7
94											4.9	4.5
96											4.7	4.2
98											4.5	3.8
100												3.5
102												3.2

working range	Main boom+ Adapter+ Tower jib+Superlift												
	24	30	36	42	48	54	60	66	72	78	84	90	
32													
34													
36													
38		28.9											
40		27.3	25.5										
42			24.0										
44			22.6	21.4									
46			21.5	20.3									
48			20.3	19.1	18.3								
50				18.0	17.2								
52				17.2	16.3	15.1							
54				16.3	15.5	14.3							
56					14.6	13.5	13						
58					13.9	12.8	12.3						
60					13.3	12.2	11.7	11					
62					12.7	11.6	11.1	10.4	10.9				
64						11	10.5	9.9	10.4				
66						10.5	10	9.3	9.8	9.4			
68							9.5	8.9	9.4	8.8			
70							9	8.4	8.8	8.4	7.6		
72							8.6	8	8.4	7.9	7.1		
74								7.6	8.0	7.5	6.7	6	
76								7.2	7.6	7.1	6.4	5.6	
78								6.8	7.2	6.7	6.0	5.2	4.3
80								6.5	6.8	6.1	5.5	4.9	4.1
82								6.1	6.4	5.8	5.2	4.7	3.9
84										5.5	5.0	4.4	3.6
86										5.1	4.7	4.2	3.4
88										4.9	4.5	4	3.1
90										4.7	4.3	3.8	2.8
92											4.1	3.6	2.5
94											3.9	3.3	2.1
96											3.7	2.9	1.8
98												2.6	1.5
100												2.3	1.2
102													

Prerequisites:

- ① Boom operating conditions (boom length+ adapter+ tower jib length), max.length is 61.8m+2.2m+66m
- ② The span of outriggers is 10.8m×10.8m
- ③ 360°rotation is applied
- ④ Counterweight is 165T
- ⑤ Superlift angle of one-side unfold is 45°
- ⑥ Angle of main boom is 67°

Prerequisites:

- ① Boom operating conditions (boom length+ adapter+ tower jib length), max.length is 73m+2.2m+66m
- ② The span of outriggers is 10.8m×10.8m
- ③ 360°rotation is applied
- ④ Counterweight is 165T
- ⑤ Superlift angle of one-side unfold is 45°
- ⑥ Angle of main boom is 67°

working range	Main boom+ Adapter+ Tower jib+Superlift							
	24	30	36	42	48	54	60	66
42	22.5							
44	21.3							
46		18.8						
48		17.7						
50		16.9	15.5					
52		15.9	14.6					
54			13.9	13.2				
56			13.2	12.4				
58			12.5	11.8	10.6			
60				11.2	10.1			
62				10.6	9.5	8.8		
64				10.0	9	8.4		
66				9.5	8.5	7.9	5.6	5.9
68					8.1	7.5	5.3	5.6
70					7.7	7.1	5	5.3
72						6.7	4.7	5.0
74						6.3	4.4	4.6
76						6	4.2	4.4
78							3.9	4.1
80							3.7	3.9
82							3.5	3.7
84							3.3	3.5
86							3.1	3.3

working range	Main boom+ Adapter+ Tower jib+Superlift					
	24	30	36	42	48	54
42						
44						
46	16.5					
48	15.6					
50		12.4				
52		11.7				
54		11.2				
56		10.6	9.1			
58			8.6			
60			8.2	6.7		
62			7.7	6.3		
64				5.9	4.4	
66				5.6	4.2	
68				5.2	3.9	1.7
70					3.7	1.6
72					3.5	1.4
74						1.2
76						1.1
78						
80						
82						
84						
86						

Prerequisites:





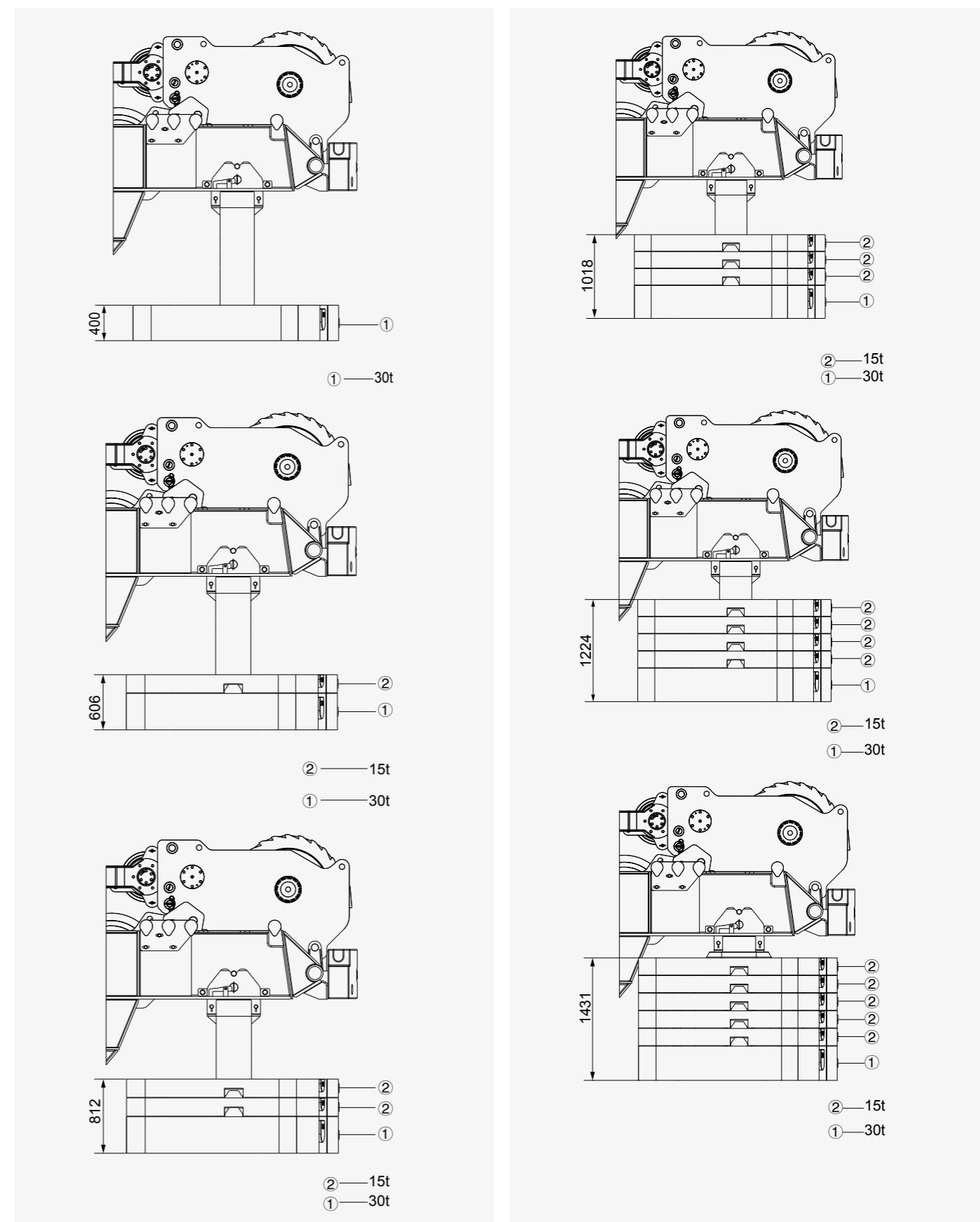

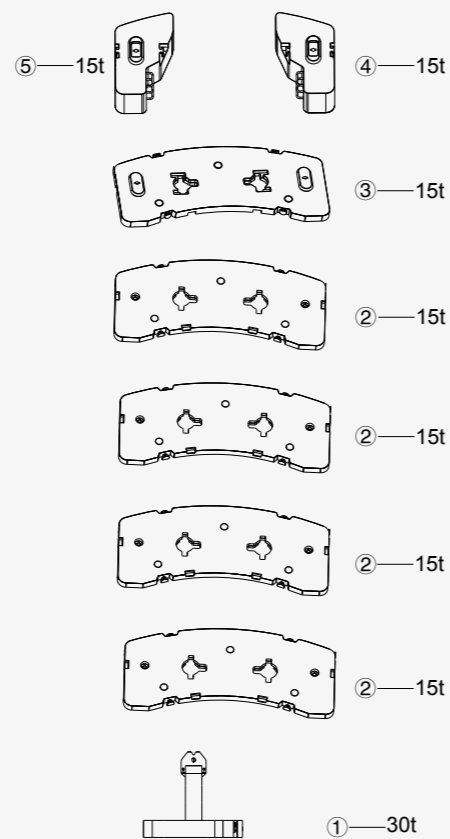
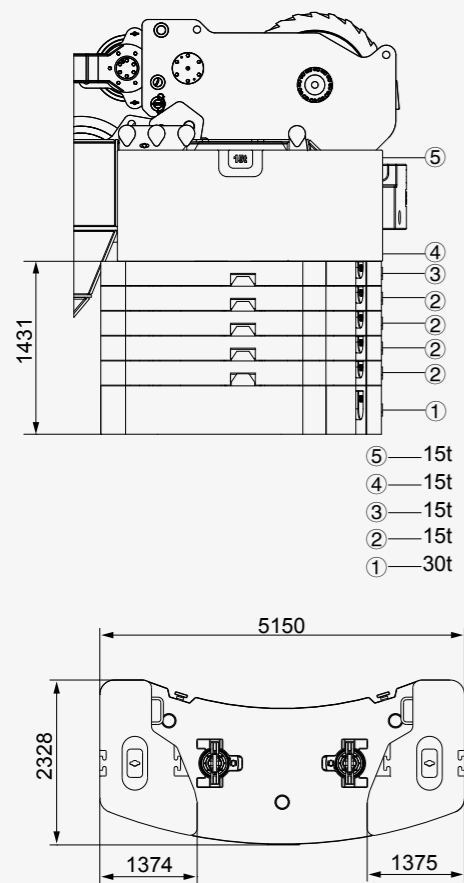
- ① Boom operating conditions(boom length+ adapter+ tower jib length), max.length is 84.2m+2.2m+36m
- ② The span of outriggers is 10.8m×10.8m
- ③ 360°rotation is applied
- ④ Counterweight is 165T
- ⑤ Superlift angle of one-side unfold is 45°
- ⑥ Angle of main boom is 67°

working range	Main boom+ Adapter+ Tower jib+Superlift		
	24	30	42
42			
44			
46			
48			
50			
52	9.9		
54			
56		5.6	
58		5.2	
60			2.9
62			2.8
64			2.6
66			
68			
70			
72			
74			
76			
78			
80			
82			
84			
86			





TRUCK CRANE

 STC200 Maximum Load Capacity: 20t Telescopic Boom: 4 Sections, 10.6-33m	 STC250 Maximum Load Capacity: 25t Telescopic Boom: 4 Sections, 10.65-33.5m	 STC250H Maximum Load Capacity: 25t Telescopic Boom: 5 Sections, 10.5-39.5m	 STC300S Maximum Load Capacity: 30t Telescopic Boom: 5 Sections, 10.6-40.5m	 STC300TH Maximum Load Capacity: 30t Telescopic Boom: 4 Sections, 10.6-33.5m
 STC300H Maximum Load Capacity: 30t Telescopic Boom: 5 Sections, 10.5-39.5m	 STC500 Maximum Load Capacity: 50t Telescopic Boom: 5 Sections, 11.5-43m	 STC550 Maximum Load Capacity: 55t Telescopic Boom: 5 Sections, 11.5-43m	 STC600S Maximum Load Capacity: 60t Telescopic Boom: 5 Sections, 11.3-43.5m	 STC750 Maximum Load Capacity: 75t Telescopic Boom: 5 Sections, 11.8-48m
 STC800S Maximum Load Capacity: 80t Telescopic Boom: 5 Sections, 12.2-47m	 STC1000 Maximum Load Capacity: 100t Telescopic Boom: 5 Sections, 13.5-52m	 STC1000C Maximum Load Capacity: 100t Telescopic Boom: 6 Sections, 13.25-60m	 STC1000S Maximum Load Capacity: 100t Telescopic Boom: 5 Sections, 12.26-56m	 STC1200S Maximum Load Capacity: 120t Telescopic Boom: 7 Sections, 12.6-63.5m
 STC1300C Maximum Load Capacity: 130t Telescopic Boom: 5 Sections, 13.3-60m	 STC1600 Maximum Load Capacity: 160t Telescopic Boom: 5 Sections, 13.4-62m	 STC2200 Maximum Load Capacity: 220t Telescopic Boom: 5 Sections, 14.55-68m		

ALL TERRAIN CRANE

 SAC1800 Maximum Load Capacity: 180t Telescopic Boom: 5 Sections, 15.5-62m	 SAC2200 Maximum Load Capacity: 220t Telescopic Boom: 6 Sections, 13.5-62m	 SAC2600 Maximum Load Capacity: 260t Telescopic Boom: 6 Sections, 15.65-73m	 SAC3000 Maximum Load Capacity: 300t Telescopic Boom: 7 Sections, 15.4-83m
 SAC3500 Maximum Load Capacity: 350t Telescopic Boom: 6 Sections, 15.2-70m	 SAC6000 Maximum Load Capacity: 600t Telescopic Boom: 7 Sections, 17.1-90m		

ROUGH-TERRAIN CRANE

 SRC250 Maximum Load Capacity: 25t Telescopic Boom: 4 Sections, 9.9-31.5m	 SRC350 Maximum Load Capacity: 35t Telescopic Boom: 4 Sections, 10-31.5m	 SRC650 Maximum Load Capacity: 55t Telescopic Boom: 4 Sections, 11.25-34.5m	 SRC650H Maximum Load Capacity: 55t Telescopic Boom: 5 Sections, 11.5-43m	 SRC750 Maximum Load Capacity: 75t Telescopic Boom: 5 Sections, 11.8-45m
 SRC1200 Maximum Load Capacity: 120t Telescopic Boom: 5 Sections, 13-49m				



Quality Changes the World

SANY AUTOMOBILE HOISTING MACHINERY

Address: SANY Industrial Park, Jinzhou Development Zone,
Changsha, Hunan, China.
Service Hotline: 4006098318
Email: crd@sany.com.cn
For more information, please visit: www.sanygroup.com

For our consistent improvement in technology, specifications may change without notice.
The machines illustrated may show optional equipment which can be supplied at additional cost.

Version: 2016.1

Distributed By: